



Abhiram J &lt;abhiram@ncjayanagar.com&gt;

---

**Project dissertation Grade and Invitation for Project Presentation event**

7 messages

---

**MOHAN A** <mohan@sjc.ac.in>  
To: abhiram@ncjayanagar.com

Mon, Jul 18, 2022 at 1:37 PM

Dear Professor

It is with great pleasure that I inform you that the Semester IV at St. Joseph's (Autonomous) College, PG Section will be coming to a completion shortly. You've been an important part of our activities by guiding our students with their project for nearly a year's time. I take this opportunity to thank you for the help you have extended to St. Joseph's and appreciate all the kindness that you've shown us.

As you were the supervisor to **Deepak Raja S (20PHY04)** and **Mathew J Mathews (20PHY15)** project, we will require one more help from you in the form of grading them.

The total grade is for 100 points of which **50 points** is delegated for internal work and will be graded by **you** (the various heads each carrying 10 points can be: Passion, Hard work/commitment, Understanding/cognition, Communication, Regularity of meeting you/meeting the deadlines you have imposed - these heads are loose and perhaps merge between themselves; please feel free to alter them as you deem fit).

The balance of 50 points will be external and be graded by us at the Department of Physics, St. Joseph's college. These grades will go for their project presentations.

**You are cordially invited to our department for the Project Presentation event.** The event is scheduled for the **4<sup>th</sup> of August 2022, 10:00 am**. The presentations will go on **till 4:00 PM** and refreshments and lunch will be provided.

**Please confirm your presence by 1<sup>st</sup> of August, 2022 midday so we can make arrangements for the food.**

Thanks, and regards

Dr. Mohan. A  
Assistant Professor,  
Department of Physics  
School of Physical Sciences  
St. Joseph's University  
Bengaluru - 560027.

PRINCIPAL  
The National College  
Jayanagar, Bangalore-70.



---

**Abhiram J** <abhiram@ncjayanagar.com>  
To: MOHAN A <mohan@sjc.ac.in>

Tue, Aug 2, 2022 at 11:58 PM

Dear Sir,

PHYSICAL AND OPTICAL STUDIES OF VANADIUM PENTOXIDE DOPED  
GLASSES

MSc. dissertation project report in partial fulfilment of the requirements for

the degree of

MASTER OF SCIENCE

IN

PHYSICS

BY

MATHEW J MATHEWS

(Reg No :20PHY15)

St. Joseph's College – Bengaluru



*[Handwritten Signature]*  
PRINCIPAL

The National College  
Jayanagar, Bangalore-70.

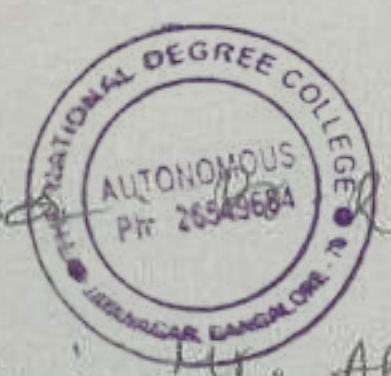

*[Handwritten Signature]*  
cosupervisor : Mr. Abhiram J



# DISSERTATION PROJECT REPORT

M.Sc Physics – III Sem



## Physical and optical studies of Vanadium Pentoxide doped with Lithium Oxide borate glasses

Research Supervisor:

Dr. R. Rajaramakrishna

Supervisor: Mr. *[Signature]*

PRINCIPAL

The National College  
Jayanagar, Bangalore-70.

BY,

DEEPAK RAJA S,  
(20PHY04)





# The National College (Autonomous)

Jayanagar, Bengaluru – 70

DEPARTMENT OF POST GRADUATE STUDIES AND RESEARCH IN PHYSICS

## CERTIFICATE

This is to certify that the present Project titled "A STUDY ON STRUCTURAL AND MORPHOLOGICAL PROPERTIES OF LI SUBSTITUTED  $MgNaO_3$  NANOPARTICLES FOR ENERGY STORAGE APPLICATIONS" has been the outcome of an original study carried out by **Mr VEERESH P S** under the supervision of **Dr. K T VASUDEVAN** towards the partial fulfilment of the requirements for the degree of Masters of Science in Physics at The National College, Jayanagar, Bangalore.

This is to further certify that the work reported is his independent original investigation and herein does not form a part of any other thesis / dissertation, on the previously forming of which a degree or diploma or a certificate has been conferred upon this or any other student in the past.



**Signature of Project Supervisor**

**Dr.P.NAGARAJU**  
Project supervisor  
Department of Post Graduate Studies &  
Research in Physics  
The National College Jayanagar,  
Bangalore-560070



**Co-Ordinator Signature**

**The Co-ordinator**  
Dept. of PG Studies in Physics  
The National College  
**AUTONOMOUS**  
Jayanagar, Bangalore - 70.



**PRINCIPAL**  
Signature of the principal  
The National College  
Jayanagar, Bangalore-70.



Date: 23 November 2023

Place: Bengaluru



# The National College (Autonomous)

Jayanagar, Bengaluru – 70

DEPARTMENT OF POST GRADUATE STUDIES AND RESEARCH IN PHYSICS

## CERTIFICATE

This is to certify that the present Project titled "SYNTHESIS AND CHARACTERISATION OF CALCIUM ZINC LITHIUM BOROPHOSPHATE GLASSES" has been the outcome of an original study carried out by **Mr SYED KASHIF** under the supervision of **Dr. P NAGARAJU** towards the partial fulfilment of the requirements for the degree of Masters of Science in Physics at The National College, Jayanagar, Bangalore.

This is to further certify that the work reported is his independent original investigation and herein does not form a part of any other thesis / dissertation, on the previously forming of which a degree or diploma or a certificate has been conferred upon this or any other student in the past.



Signature of Project Supervisor

**Dr.P.NAGARAJU**  
Project supervisor  
Department of Post Graduate Studies &  
Research in Physics  
The National College Jayanagar,  
Bangalore-560070



Co-Ordinator Signature

**The Co-ordinator**  
Dept. of PG Studies in Physics  
The National College  
**AUTONOMOUS**  
Jayanagar, Bangalore - 70.



**PRINCIPAL**  
Signature of the principal  
The National College  
Jayanagar, Bangalore-70.



Date: 23 November 2023

Place: Bengaluru



|| ತ್ರದ್ಧಾಢಿ ಪರಮಾ ಗತಿಃ ||

## CERTIFICATE

**Department of Physics and Research,  
The National College, Jayanagar, Bangalore.**

This is to certify that the present Project titled "*Structural and electrical studies on  $V_2O_5$  doped  $B_2O_3-Al_2O_3-TiO_2-SrCO_3$  ceramics*" has been the outcome of an original study carried out by **Swathi S** under the supervision of **Assistant Prof. Reshma K** towards the partial fulfilment of the requirements for the degree of M.Sc. Physics of The National College, Jayanagar, Bangalore.

This is to further certify that the work reported herein does not form a part of any other thesis/dissertation, on the basis of which a degree, diploma or certificate has been conferred upon this or any other student in the past.

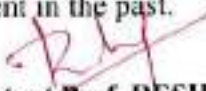
  
**Assistant Prof. RESHMA K**

Project Supervisor

  
Department of Physics and Research  
The National College, Jayanagar, Bangalore  
**PRINCIPAL**  
The National College  
Jayanagar, Bangalore-70.







|| ಶ್ರದ್ಧಾಪಿ ಪರಮಾ ಗತಿಃ ||

Department of Physics and Research,  
The National College, Jayanagar, Bangalore.

### CERTIFICATE

This is to certify that the present Project titled "*Structural, morphological, optical, dielectric study of transition bimetal oxides prepared by sol-gel combustion method*" has been the outcome of an original study carried out by Sunith R under the supervision of Assistant Prof. Reshma K towards the partial fulfilment of the requirements for the degree of M.Sc. Physics of The National College, Jayanagar, Bangalore.

This is to further certify that the work reported herein does not form a part of any other thesis/dissertation, on the basis of which a degree, diploma or a certificate has been conferred upon this or any other student in the past.

Assistant Prof. Reshma K

Project Supervisor

Department of Physics and Research

The National College, Jayanagar

Bangalore

PRINCIPAL

The National College  
Jayanagar, Bangalore-70.



# The National College (Autonomous)

Jayanagar, Bengaluru – 70

DEPARTMENT OF POST GRADUATE STUDIES AND RESEARCH IN PHYSICS

## CERTIFICATE

This is to certify that the present Project titled "SYNTHESIS OF REDUCED GRAPHENE OXIDE FROM CHICORY MIXED COFFEE POWDER USING SOLID STATE COMBUSTION METHOD" has been the outcome of an original study carried out by Mr. PAVANKALYAN under the supervision of Dr. THEJAS R towards the partial fulfilment of the requirements for the degree of Masters of Science in Physics at The National College, Jayanagar, Bangalore.

This is to further certify that the work reported is his independent original investigation and herein does not form a part of any other thesis / dissertation, on the previously forming of which a degree or diploma or a certificate has been conferred upon this or any other student in the past.



Signature of Project Supervisor

**Dr. THEJAS R**

Assistant Professor

Department of Post Graduate Studies &

Research in Physics

The National College Jayanagar,

Bangalore-560070



Coordinator Signature

**The Co-ordinator**

Dept. of PG Studies in Physics

The National College

**AUTONOMOUS**

Jayanagar, Bangalore - 70.



PRINCIPAL

The National College  
Jayanagar, Bangalore-70.



Signature of the principal

The National College  
Jayanagar, Bangalore-70.



Date: 23/11/2023

Place: Bengaluru



# The National College (Autonomous)

Jayanagar, Bengaluru - 70

DEPARTMENT OF POST GRADUATE STUDIES AND RESEARCH IN PHYSICS

## CERTIFICATE

This is to certify that the present Project titled " A STUDY ON STRUCTURAL AND MORPHOLOGICAL PROPERTIES OF Al DOPED  $\text{NaLiO}_3$  NANOPARTICLES FOR ENERGY STORAGE APPLICATIONS" has been the outcome of an original study carried out by **Mr. MOHAN KUMAR G** under the supervision of **Dr. K T VASUDEVAN** towards the partial fulfilment of the requirements for the degree of Masters of Science in Physics at The National College, Jayanagar, Bangalore.

This is to further certify that the work reported is his/her independent original investigation and herein does not form a part of any other thesis / dissertation, on the previously forming of which a degree or diploma or a certificate has been conferred upon this or any other student in the past.

  
Signature of Project Supervisor

**Dr. K T VASUDEVAN**

Co-Ordinator

Department of Post Graduate &  
Research in Physics

The National College Jayanagar - 700070

  
Co-Ordinator Signature

The Co-ordinator  
Dept. of PG Studies in Physics  
The National College  
Jayanagar, Bangalore - 70.

  
PRINCIPAL  
The National College  
Jayanagar, Bangalore-70.

Signature of the principal



Date: 23 November 2023

Place: Bengaluru



॥ ಪ್ರವೃತ್ತಿ ಪರಮಾ ಗತಿ: ॥

Department of Physics and Research,  
The National College, Jayanagar, Bangalore.

## CERTIFICATE

This is to certify that the present Project titled "*Bio-active investigations of rare earth - doped bimetal oxide nanoparticles to enhance antimicrobial properties*" has been the outcome of an original study carried out by **Keerthana Jayaprakash** under the supervision of **Assistant Prof. Reshma K** towards the partial fulfilment of the requirements for the degree of M.Sc Physics of The National College, Jayanagar, Bangalore.

This is to further certify that the work reported herein does not form a part of any other thesis/dissertation, on the basis of which a degree, diploma or a certificate has been conferred upon this or any other student in the past.

**Assistant Prof. Reshma K**

Project Supervisor

PRINCIPAL  
Department of Physics and Research  
The National College  
Jayanagar, Bangalore-70.  
The National College, Jayanagar, Bangalore





# The National College (Autonomous)

Jayanagar, Bengaluru – 70

DEPARTMENT OF POST GRADUATE STUDIES AND RESEARCH IN PHYSICS

## CERTIFICATE

This is to certify that the present Project titled "A STUDY ON STRUCTURAL AND MORPHOLOGICAL PROPERTIES OF Na SUBSTITUTED  $\text{AlCaO}_3$  NANOPARTICLES FOR CATALYSIS APPLICATIONS" has been the outcome of an original study carried out by Mr. DILIP CHANDRA MR under the supervision of Dr. K T VASUDEVAN towards the partial fulfilment of the requirements for the degree of Masters of Science in Physics at The National College, Jayanagar, Bangalore.

This is to further certify that the work reported is his/her independent original investigation and herein does not form a part of any other thesis / dissertation, on the previously forming of which a degree or diploma or a certificate has been conferred upon this or any other student in the past.

  
Signature of Project Supervisor

Dr. K T VASUDEVAN

Co-Ordinator

Department of Post Graduate &

Research in Physics

The National College Jayanagar-560070

  
Co-Ordinator Signature

The Co-ordinator  
Dept. of PG Studies in Physics  
The National College  
AUTONOMOUS  
Jayanagar, Bangalore - 70.

  
PRINCIPAL  
The National College  
Jayanagar, Bangalore-70  
Signature of the principal



Date: 23 November 2023

Place: Bengaluru

# The National College (Autonomous)

Jayanagar, Bengaluru – 70

DEPARTMENT OF POST GRADUATE STUDIES AND RESEARCH IN PHYSICS

## CERTIFICATE

This is to certify that the present Project titled **“THE EFFECT OF CRYSTAL GROWTH ON PHYSICAL, STRUCTURAL AND RADIATION SHEILDING PROPERTIES OF LEAD VANDOBORATE GLASSY SYSTEM”** has been the outcome of an original study carried out by **Mr DARSHAN A** under the supervision of **Dr. THEJAS R** towards the partial fulfilment of the requirements for the degree of Masters of Science in Physics at The National College, Jayanagar, Bangalore.

This is to further certify that the work reported is his independent original investigation and here in does not form a part of any other thesis on the previously forming of which a degree or diploma or a certificate has been conferred upon this or any other student in the past.

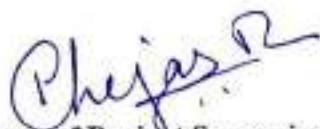

Signature of Project Supervisor

**Dr. THEJAS R**

Assistant Professor

Department of Post Graduate &  
Research in physics

The National College Jaynagar-560070.



The Co-ordinator  
Dept. of PG Studies in Physics  
The National College  
AUTONOMOUS  
Jayanagar, Bangalore - 70.



PRINCIPAL  
The National College  
Jayanagar, Bangalore-70.  
Signature of the principal



Date: 23 November 2023

Place: Bengaluru



# The National College (Autonomous)

Jayanagar, Bengaluru – 70

DEPARTMENT OF POST GRADUATE STUDIES AND RESEARCH IN PHYSICS

## CERTIFICATE

This is to certify that the present Project titled **“STRUCTURAL, PHYSICAL AND OPTICAL PROPERTIES OF LEAD VANDOBORATE GLASSY SYSTEM”** has been the outcome of an original study carried out by **Mr BHARATH Kunder** the supervision of **Dr. THEJAS R** towards the partial fulfilment of the requirements for the degree of Masters of Science in Physics at The National College, Jayanagar, Bangalore.

This is to further certify that the work reported is his independent original investigation and here in does not form a part of any other thesis on the previously forming of which a degree or diploma or a certificate has been conferred upon this or any other student in the past.



Signature of Project Supervisor

**Dr. THEJAS R**

Assistant Professor

Department of Post Graduate &  
Research in physics

The National College Jayanagar-560070



PRINCIPAL  
The National College  
Jayanagar, Bangalore-70

Signature of the principal



The Co-ordinator  
Dept. of PG Studies in Physics  
The National College  
Autonomous  
Jayanagar, Bangalore - 70.



Date: 23 November 2023

Place: Bengaluru

# The National College (Autonomous)

Jayanagar, Bengaluru – 70

DEPARTMENT OF POST GRADUATE STUDIES AND RESEARCH IN PHYSICS

## CERTIFICATE

This is to certify that the present Project titled “**THE STRUCTURAL AND OPTICAL PROPERTIES OF LITHIUM ALUMINA ZINC BORATE GLASS DOPED WITH  $\text{Eu}^{2+}$** ” has been the outcome of an original study carried out by **Mr. L YUVARAJ KUMAR** under the supervision of **Dr. THEJAS R** towards the partial fulfilment of the requirements for the degree of Masters of Science in Physics at The National College, Jayanagar, Bangalore.

This is to further certify that the work reported is his independent original investigation and herein does not form a part of any other thesis/dissertation, on the previously forming of which a degree or diploma or a certificate has been conferred upon this or any other student in the past.



Signature of Project Supervisor

**Dr. THEJAS R**

Assistant Professor

Department of Post Graduate &

Research in physics

The National College Jayanagar-560070

The Co-ordinator  
Dept. of PG Studies in Physics  
The National College  
AUTONOMOUS  
Jayanagar, Bangalore - 70.  
Co-Ordinator Signature



Signature of the principal

PRINCIPAL

The National College  
Jayanagar, Bangalore-70.

Date: 23 November 2023

Place: Bengaluru





# The National College (Autonomous)

Jayanagar, Bengaluru – 70

DEPARTMENT OF POST GRADUATE STUDIES AND RESEARCH IN PHYSICS

## CERTIFICATE

This is to certify that the present Project titled “ SYNTHESIS AND CHARACTERIZATION OF CALCIUM ZINC KITHIUM BOROPHOSPATE GLASSES” has been the outcome of an original study carried out by **Mr. SRIKANTH SR** under the supervision of **Dr. P. NAGARAJU** towards the partial fulfilment of the requirements for the degree of Masters of Science in Physics at The National College, Jayanagar, Bangalore.

This is to further certify that the work reported is his/her independent original investigation and herein does not form a part of any other thesis / dissertation, on the previously forming of which a degree or diploma or a certificate has been conferred upon this or any other student in the past.



Signature of Project Supervisor

**Dr.P.NAGARAJU**  
Project supervisor  
Department of Post Graduate Studies &  
Research in Physics  
The National College Jayanagar,  
Bangalore-560070



Co-Ordinator Signature  
The Co-ordinator  
Dept. of PG Studies in Physics  
The National College  
AUTONOMOUS  
Jayanagar, Bangalore - 70.



PRINCIPAL  
The National College  
Signature of the principal



Date: 23 November 2023

Place: Bengaluru



|| ಶ್ರದ್ಧಾಂ ಪರಮಾ ಗತಃ ||

# THE NATIONAL COLLEGE

**AUTONOMOUS**  
**JAYANAGAR, BANGALORE-560070**

*X-Ray Diffraction Studies on Ag Nanoparticles and Thin films*

A PROJECT REPORT

Submitted by

**VINAY D**  
**20NCJPP011**

*As partial fulfillment of award degree in*

**MASTER OF SCIENCE (Physics)**

UNDER THE GUIDANCE OF

Dr. K T Vasudevan

Co-ordinator

Dr. Abhiram J

Assistant Professor

Department of Post Graduate Studies & Research in Physics

The National College Jayanagara, Bangalore-560 070

PRINCIPAL

The National College  
Jayanagar, Bangalore-560070

2022







॥ वाचं धेनुमुपासीत ॥

# THE NATIONAL COLLEGE

AUTONOMOUS  
JAYANAGAR, BANGALORE-560070

*X-RAY DIFFRACTION STUDIES ON COPPER OXIDE  
NANOPARTICLES AND THIN FILMS*

A PROJECT REPORT

Submitted by

**SIDDIVINAYAKA T S**  
**20NCJPP009**

*As partial fulfillment of the award of the degree in*

MASTER OF SCIENCE (Physics)

UNDER THE GUIDANCE OF

Dr. K T Vasudevan

Co-ordinator

Dr. Abhiram J

Assistant Professor

Department of Post Graduate Studies & Research in Physics

The National College Jayanagara, Bangalore-560 070

PRINCIPAL  
The National College  
Jayanagar, Bangalore-70.

2022







॥ त्र्यम्बकं यजन्तु नागाः ॥

# THE NATIONAL COLLEGE

NAAC ACCREDITED "A" GRADE

JAYANAGAR, BANGALORE-560 070

## OPTICAL PROPERTIES OF ALKALI BARIUM ALUMINO BORATE GLASS

A PROJECT REPORT

Submitted by

**Shubham Jha**

*As Partial fulfillment of award of the degree in*

MASTER OF SCIENCE (Physics)

## UNDER THE GUIDANCE OF

**Dr. Abhiram J,**

Assistant Professor,

Department of PG Studies and Research in Physics

The National College, Jayanagar, Bangalore – 560070

PRINCIPAL  
(2022)  
The National College  
Jayanagar, Bangalore-70.







॥ ज्ञानं ततो भवेत् ॥

# THE NATIONAL COLLEGE

NAAC ACCREDITED "A" GRADE  
JAYANAGAR, BANGALORE-560 070

## NON-LINEAR OPTICAL PROPERTIES OF ALKALI BARIUM ALUMINOBORATE GLASS

A PROJECT REPORT  
Submitted by

**R Dhanya**

*As Partial fulfilment of award of the degree in*  
MASTER OF SCIENCE (Physics)

**UNDER THE GUIDANCE OF**

**Dr. Abhiram J**

Assistant professor,

Department of PG Studies and Research in Physics  
The National College, Jayanagar, Bangalore - 560070

PRINCIPAL

The National College  
Jayanagar, Bangalore-70.



(2022)





|| ಶ್ರದ್ಧಾಢಿ ಪರಮಾ ಗಿಃ ||

# THE NATIONAL COLLEGE

NAAC ACCREDITED WITH GRADE "A"

JAYANAGAR, BANGALORE-560070

A STUDY ON PHYSICAL AND OPTICAL PROPERTIES OF ALKALI ALUMINO  
BORATE GLASSES DOPED WITH  $V_2O_5$

A PROJECT REPORT

Submitted by

**CHANDANA SRINIVASU**

**20NCJPP002**

*As a partial fulfillment of the award of the degree in*

MASTER OF SCIENCE (Physics)

UNDER THE GUIDANCE OF

Dr. Abhiram J

Assistant Professor,

Department of Post Graduate Studies & Research in Physics

The National College Jayanagar, Bangalore-560070

PRINCIPAL

The National College  
Jayanagar, Bangalore-70.



2022





|| ಶ್ರೀಮತು ವಿದ್ಯಾಪತಿ ರಾಜಃ ||

# THE NATIONAL COLLEGE

NAAC ACCREDITED "A" GRADE

JAYANAGAR, BANGALORE-560070

INFRARED SPECTROSCOPIC ANALYSIS OF ALKALI ALUMINO BORATE GLASSES DOPED  
WITH  $V_2O_5$

## A PROJECT REPORT

Submitted by

**Kanaka G**

20NCJPP003

*As a partial fulfillment of the award of the degree in*

MASTER OF SCIENCE (Physics)

UNDER THE GUIDANCE OF

**Dr. Abhiram J**

Assistant professor,

Department of Post Graduate Studies & Research in Physics

The National College Jayanagar, Bangalore-560070

The National College  
Jayanagar, Bangalore-70.

2022







|| ಶ್ರದ್ಧಾ಼ ಪರಮಾ ಗಣಿಃ ||

# THE NATIONAL COLLEGE

NAAC ACCREDITED "A" GRADE  
JAYANAGAR, BANGALORE-560 070

## INFRA-RED SPECTROSCOPIC ANALYSIS OF ALKALI SODIUM BORATE GLASSES DOPED WITH $V_2O_5$

A PROJECT REPORT  
Submitted by

**Achala Dattatreya Hegde**

**20NCJPP001**

*As Partial fulfilment of award of the degree in*  
MASTER OF SCIENCE (Physics)

UNDER THE GUIDANCE OF

**Dr. Abhiram J**

Assistance Professor,

Department of PG Studies and Research in Physics  
The National College, Jayanagar, Bangalore - 560070

PRINCIPAL

The National College  
Jayanagar, Bangalore-70.



(2022)





|| ಶ್ರದ್ಧಾಕು ಪರಮಾ ನಮಃ ||

# THE NATIONAL COLLEGE

NACC ACCREDITED "A" GRADE  
JAYANAGAR, BANGALORE-560 070

INFRARED SPECTROSCOPIC ANALYSIS OF LITHIUM BARIUM  
ALUMINO BORATE GLASSES DOPED WITH  $V_2O_5$

## A PROJECT REPORT

Submitted by

**Mamatha S K**  
**20NCJPP004**

*As partial fulfillment of the award of the degree in*

**MASTER OF SCIENCE (Physics)**

UNDER THE GUIDANCE OF

  
**Dr. Abhiram J**  
Assistant Professor

The National College  
Jayanagar, Bangalore-70.

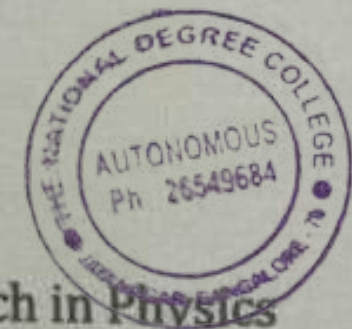

Department of Post Graduate Studies & Research in **Physics**

The National College Jayanagar, Bangalore-560 070

2022

Name: Pallavi V

Dear Pallavi,

Thank you for seeking and fulfilling an election-specific five-day internship with NDTV for coverage of the Karnataka Assembly Elections 2023.

We wish you the very best for your future.

Best Wishes,



**Anuradha Srinivasan**  
**Head-HR NDTV Group**



**PRINCIPAL**  
**The National College**  
**Jayanagar, Bangalore-70**





Name: Meghana M

Dear Meghana,

Thank you for seeking and fulfilling an election-specific five-day internship with NDTV for coverage of the Karnataka Assembly Elections 2023.

We wish you the very best for your future.

Best Wishes,

**Anuradha Srinivasan**  
**Head-HR NDTV Group**

**PRINCIPAL**  
**The National College**  
**Jayanagar, Bangalore-70**



Name: Lohith G

Dear Lohith,

Thank you for seeking and fulfilling an election-specific five-day internship with NDTV for coverage of the Karnataka Assembly Elections 2023.

We wish you the very best for your future.

Best Wishes,



**Anuradha Srinivasan**  
**Head-HR NDTV Group**



**PRINCIPAL**  
**The National College**  
**Jayanagar, Bangalore-70**





Name: Kunjal Narwal

Dear Kunjal,

Thank you for seeking and fulfilling an election-specific five-day internship with NDTV for coverage of the Karnataka Assembly Elections 2023.

We wish you the very best for your future.

Best Wishes,

*Anuradha*

**Anuradha Srinivasan**  
**Head-HR NDTV Group**

*S. Sush*  
PRINCIPAL  
The National College  
Jayanagar, Bangalore-70





सेंटर फॉर डेवलपमेंट ऑफ टेलीमैटिक्स  
भारत सरकार का दूरसंचार प्रौद्योगिकी केन्द्र  
Centre for Development of Telematics  
TELECOM TECHNOLOGY CENTRE OF GOVT. OF INDIA

27 मार्च, 2023

प्रमाण पत्र  
**CERTIFICATE**

प्रमाणित किया जाता है कि नेशनल कॉलेज जयनगर, बेंगलुरु से सुश्री कीर्तना जयप्रकाश रोल नं. P03PA21S0001 ने 18 जनवरी 2023 से 17 मार्च 2023 तक सेंटर फॉर डेवलपमेंट ऑफ टेलीमैटिक्स, बेंगलूर के ज्ञान प्रबंधन समूह में "Solar Powered Wi-Fi & AOI" शीर्षित विषय पर प्रोजेक्ट की है। उनका कार्य निष्पादन अच्छा पाया गया।

This is to certify that **Ms Keerthana Jayaprakash**, bearing Reg. No. P03PA21S0001 from **National College Jayanagar**, Bengaluru has done Project training in Knowledge Management Group, Centre for Development of Telematics, Bangalore, from 18th January 2023 to 17th March 2023 on the topic titled "**Solar Powered Wi-Fi & AOI**". His/her performance was found to be good.

वाई.वी.एस. लक्ष्मी 27/3/2023

डॉ. वाई.वी.एस. लक्ष्मी / Dr. Y.V.S. LAKSHMI  
ग्रुप लीडर / Group Leader  
ज्ञान प्रबंधन समूह / Knowledge Management Group

डॉ. वाई.वी.एस. लक्ष्मी / Dr. Y.V.S. Lakshmi  
ग्रुप लीडर - आईटीआर, ज्ञान प्रबंधन समूह  
Group Leader - IPR, Management Group  
सेंटर फॉर डेवलपमेंट ऑफ टेलीमैटिक्स  
Centre for Development of Telematics  
भारत सरकार / GOVT. OF INDIA  
इलेक्ट्रॉनिक्स सिटी फेज-1, होसूर रोड, बेंगलूर - 560 100.  
Electronics City Phase-1, Hosur Road, Bangalore - 560 100.





Name: Gowthami

Dear Gowthami,

Thank you for seeking and fulfilling an election-specific five-day internship with NDTV for coverage of the Karnataka Assembly Elections 2023.

We wish you the very best for your future.

Best Wishes,

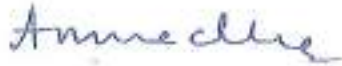

**Anuradha Srinivasan**  
**Head-HR NDTV Group**



**PRINCIPAL**  
**The National College**  
**Jayanagar, Bangalore-70**



Name: Deepthi M

Dear Deepthi,

Thank you for seeking and fulfilling an election-specific five-day internship with NDTV for coverage of the Karnataka Assembly Elections 2023.

We wish you the very best for your future.

Best Wishes,

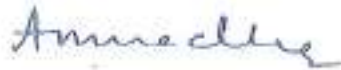

**Anuradha Srinivasan**  
**Head-HR NDTV Group**



**PRINCIPAL**  
**The National College**  
**Jayanagar, Bangalore-70**







|| ಶ್ರವಣ ಸು ವರವಾಸು ನತಃ ||

# THE NATIONAL COLLEGE

Autonomous

Jayanagar, Bangalore-560070

## DEPARTMENT OF ELECTRONICS

### CERTIFICATE

This is to certify the project report titled "**Smart Door System**" is a bonafede record of work done by **Mary Prerana.A [20NCJS229]** and **Vedavidhya [20NCJS215]** in partial fulfilment of the requirements of the Bachelor of Science from THE NATIONAL COLLEGE, Jayanagar, for the academic year 2023-2024. The project has been approved as it satisfies the academic requirement in the respect of the project work prescribed for the VI Semester B.Sc.

.....*M. Mahadev*.....

.....*Chelluvapa S*.....

Prof .MAHADEV M (MSc, MPhil)

Prof .CHELLUVAPA S (MSc)

[ASSOC PROF,

[HOD and INTERNAL]

AND INTERNAL GUIDE]

VALUED BY:

*S. Sush*  
**VALUED**  
 PRINCIPAL  
 Signature of the Examiners  
 The National College  
 Jayanagar, Bangalore-70.  
 1) *Chelluvapa S*  
 2) *Mahadev*  
 Date *30-8-23*



DATE OF EXAM:

# THE NATIONAL COLLEGE

Autonomous

Jayanagar, Bangalore-560070

## DEPARTMENT OF ELECTRONICS

### CERTIFICATE

This is to certify the project report titled "*SMART PARKING SYSYTEM*" is a bonafide record of work done by *PADMANABHA N KATTI* [20NCJS214], *KARNA R* [20NCJS228] & *RAMYASHREE G* [16NCJS239] in partial fulfilment of the requirements of the Bachelor of Science from THE NATIONAL COLLEGE, Jayanagar, for the academic year 2022-2023. The project has been approved as it satisfies the academic requirement in the respect of the project work prescribed for the 6th Semester B.Sc.



PROF.CHELLUVAPA S  
[HOD & INTERNAL GUIDE]



PROF.MAHADEV M  
[ASSOC PROF, INTERNAL]



PRINCIPAL  
The National College  
Jayanagar, Bangalore-70



VALUED BY:

<b>VALUED</b>	
Signatures of Examiners	
1)	
2)	
Date	30-8-2023

Name:

Date of Exam:



# THE NATIONAL COLLEGE

Autonomous Jayanagar,  
Bangalore-560070

## DEPARTMENT OF ELECTRONICS

### CERTIFICATE

This is to certify the project report titled "*IOT-BASED AIR POLLUTION MONITORING SYSTEM*" is a bonafide record of work done by *SRIKANTH N [20NCJS225]* and *SHARAN K [20NCJS227]* in partial fulfillment of the requirements of the Bachelor of Science from THE NATIONAL COLLEGE, Jayanagar, for the academic year 2022-2023. The project has been approved as it satisfies the academic requirement in the respect of the project work prescribed for the 6<sup>th</sup> Semester B.Sc.

.....*M. Mahadev M*.....  
Prof. MAHADEV M (MSc, MPhil)  
[ASSOC PROF, and INTERNAL GUIDE ]

.....*Chelluvapa S*.....  
Prof. CHELLUVAPA S (MSc)  
[HOD and INTERNAL]

VALUED BY:

VALUED	
Signatures of Examiners	
1)	<i>[Signature]</i>
2)	<i>[Signature]</i>
Date	<i>30-07-23</i>

NAME:

DATE OF EXAM:

PRINCIPAL  
The National College  
Jayanagar, Bangalore-70.



# THE NATIONAL COLLEGE

Autonomous

Jayanagar, Bangalore-560070

## DEPARTMENT OF ELECTRONICS

### CERTIFICATE

This is to certify the project report titled "**SURVEILLANCE ROBOT ESP32 CAM**" is a Bonafede record of work done by **DEVAMSH.U [20NCJS223]** and **YESHWANTH.R [20NCJS226]** in partial fulfilment of the requirements of the Bachelor of Science from **THE NATIONAL COLLEGE, Jayanagar**, for the academic year 2022-2023. The project has been approved as it satisfies the academic requirement in the respect of the project work prescribed for the 6<sup>th</sup> Semester B.Sc.

.....*M. Mahadev M*.....

Prof .MAHADEV M (MSc, MPhil)  
[ASSOC PROF, and INTERNAL GUIDE ]

.....*Chelluvapa S*.....

Prof .CHELLUVAPA S (MSc)  
[HOD and INTERNAL]

VALUED BY:

VALUED	
Signatures of Examiners	
1)	<i>[Signature]</i>
2)	<i>[Signature]</i> PRINCIPAL
Date	30/11/2023 The National College Jayanagar, Bangalore-70

NAME

DATE OF EXAM

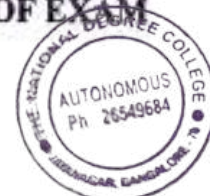



# THE NATIONAL COLLEGE

Autonomous Jayanagar,  
Bangalore-560070

## DEPARTMENT OF ELECTRONICS

### CERTIFICATE

This is to certify the project report titled "*IOT-BASED AIR POLLUTION MONITORING SYSTEM*" is a bonafide record of work done by *SRIKANTH N* [20NCJS225] and *SHARAN K* [20NCJS227] in partial fulfillment of the requirements of the Bachelor of Science from **THE NATIONAL COLLEGE, Jayanagar**, for the academic year 2022-2023. The project has been approved as it satisfies the academic requirement in the respect of the project work prescribed for the 6<sup>th</sup> Semester B.Sc.

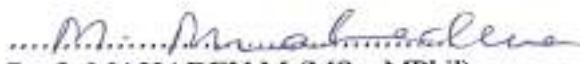
  
Prof. MAHADEV M (MSc, MPhil)  
[ASSOC PROF, and INTERNAL GUIDE ]

  
Prof. CHELLUVAPA S (MSc)  
[HOD and INTERNAL]

VALUED BY:

VALUED	
Signatures of Examiners	
1)	
2)	
Date: 30-05-2023	
The National College Jayanagar, Bangalore-70	

NAME:

DATE OF EXAM:





|| ಶ್ರವಣಂ ಮನನಂ ನಮಃ ||

# THE NATIONAL COLLEGE

Autonomous

Jayanagar, Bangalore-560070

## DEPARTMENT OF ELECTRONICS

### CERTIFICATE

This is to certify the project report titled "**HEALTH MONITORING SYSTEM**" is a bonafide record of work done by **GOMATH KUMAR L [20NCJS224]** and **BHARATH R [20NCJS222]** in partial fulfilment of the requirements of the Bachelor of Science from **THE NATIONAL COLLEGE, Jayanagar**, for the academic year **2022-2023**. The project has been approved as it satisfies the academic requirement in the respect of the project work prescribed for the **VI Semester B.Sc.**

.....*M. Mahadevm*.....

.....*Chelluvapas*.....

Prof .MAHADEVM (MSc, MPhil)  
[ASSOC PROF,

*Principal*  
PRINCIPAL  
The National College  
Jayanagar, Bangalore-70

Prof.CHELLUVAPAS (MSc)  
[HOD and INTERNAL



AND INTERNAL GUIDE]

VALUED BY:

<b>VALUED</b>	
Signatures of Examiners	
1)	<i>Chelluvapas</i>
2)	<i>Mahadevm</i>
Date	<i>30-8-2023</i>

NAME:

DATE OF EXAM:



# THE NATIONAL COLLEGE

Autonomous

Jayanagar, Bangalore-560070

## DEPARTMENT OF ELECTRONICS

### CERTIFICATE

This is to certify the project report titled "*SURVEILLANCE ROBOT ESP32 CAM*" is a Bonafede record of work done by *DEVAMSHU* [20NCJS223] and *YESHWANTH.R* [20NCJS226] in partial fulfilment of the requirements of the Bachelor of Science from **THE NATIONAL COLLEGE, Jayanagar**, for the academic year 2022-2023. The project has been approved as it satisfies the academic requirement in the respect of the project work prescribed for the 6<sup>th</sup> Semester B.Sc.

.....*M. Mahadeva*.....

Prof .MAHADEV M (MSc, MPhil)  
[ASSOC PROF, and INTERNAL GUIDE ]

.....*Chelluvapa S*.....

Prof .CHELLUVAPA S (MSc)  
[HOD and INTERNAL]

VALUED BY:

VALUED	
Signatures of Examiners	
1)	<i>[Signature]</i> PRINCIPAL
2)	<i>[Signature]</i> The National College Jayanagar, Bangalore-70
Date	<i>30.8.2022</i>

NAME  
DATE OF EXAM





ಶ್ರೀ ಶಿವಕಾಮ ಮಹಾದೇವ ಸ್ವಾಮಿ

# THE NATIONAL COLLEGE

Autonomous

Jayanagar, Bangalore-560070

## DEPARTMENT OF ELECTRONICS

### CERTIFICATE

This is to certify the project report titled "**HEALTH MONITORING SYSTEM**" is a bonafide record of work done by **GOMATH KUMAR L [20NCJS224]** and **BHARATH R [20NCJS222]** in partial fulfilment of the requirements of the Bachelor of Science from **THE NATIONAL COLLEGE, Jayanagar**, for the academic year **2022-2023**. The project has been approved as it satisfies the academic requirement in the respect of the project work prescribed for the **VI Semester B.Sc.**

.....*M. Mahadevm*.....

.....*Chelluvapas*.....

Prof .MAHADEVM (MSc, MPhil)  
[ASSOC PROF,

Prof.CHELLUVAPAS (MSc)  
[HOD and INTERNAL]

AND INTERNAL GUIDE]

*D. Subh*  
PRINCIPAL

VALUED BY:

**VALID**  
The National College  
Jayanagar, Bangalore-7  
Signatures of Examiners  
1) *Chelluvapas*  
2) *Mahadevm*  
Date *30-8-2023*

NAME:

DATE OF EXAM:





Bisleri

BISLERI INTERNATIONAL PVT. LTD.

Date: 27/08/2022

**TO WHOM SO EVER IT MAY CONCERN**

This is to certify that Ms.Sushmitha N (20NCJPCM05) M.Com student from The National College Autonomous, Jayanagar, Bangalore has successfully completed her project work on the topic "A Study on Marketing Strategies and Brand Image with Remarks to Bisleri Mineral Water" under our guidance.

We wish her all the success in her future endeavors.

For Bisleri International Pvt. Ltd.

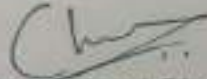
  
Authorised Signatory

  
PRINCIPAL  
The National College  
Jayanagar, Bangalore-70

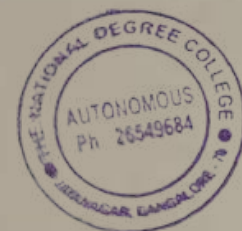

29/33, Udayagiri Village, Devanhalli Taluk, Bengaluru - 562 110  
Customer Care: +91-99009 79800 | E-mail: bangalore@bisleri.co.in

**TO WHOM SO EVER IT MAY CONCERN**

This is to certify that Ms.Suchita H (20NCJPCM04) M.com student The National College Autonomous, Jayanagar, Bangalore has successfully completed the project work on "A STUDY ON E-RECRUITMENT IN HUMAN RESOURCE DEPARTMENT"

During the period of her project with us she has exhibited punctuality and diligence.

We wish her every success in life.

**For Strides Pharma Science Limited,**



MANJULA RAMURTHY  
Sr. Manager - HR

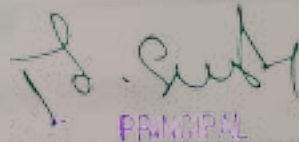

PRINCIPAL  
The National College  
Jayanagar, Bangalore-70

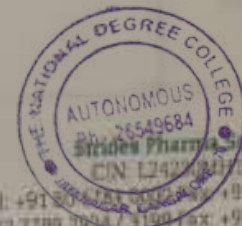





# PEOPLE STREET CONSULTANCY

No.33, M V Road, V V Puram, Bangalore 560004

PH: 9742164459/7812994687

E-Mail ID: peoplestreet.consultants@gmail.com

Date: 02<sup>nd</sup> Sept, 2022

## CERTIFICATE

This is to certify that **Ms. Pruthvi H R**, Register no. **20NCJPCM03**, 4<sup>th</sup> Semester M.Com, a student of The National College, Jayanagar, has completed her project for the period of 30 days in the field of Payroll starting from 04<sup>th</sup> August, 2022 to 30<sup>th</sup> August, 2022 with reference to People Street Consultancy.

During the project she was exposed to various activities in payroll department. We found her to be meticulous, inquisitive hardworking. she was very much interested in to learn the functions of our division and also willing to put efforts and get into the depth of the concept to understand well.

Her association with us was very fruitful and wish her all the best for his future endeavors.

For People Street Consultancy

Authorised Signatory

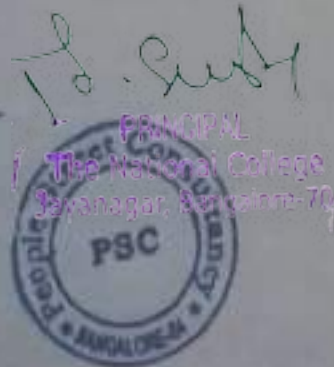

PRINCIPAL  
The National College  
Jayanagar, Bangalore-79



**SRI VINAYAKA WOMEN SELF-HELP GROUP**

**Muninagra village Kaggalahalli Grama, harohalli hobali, kanakapura thaluku,  
Ramanagara district 562112**

---

**Date: 30.09.2022**

**Proprietor**

**Mamatha J.K**

**CERTIFICATE**

**This is certify that Miss. Pranitha (Reg. No. 20NCJPCM02) M.COM Student of National college Jayanagar Bangalore, Has Successfully completed her project work "Women Empowerment Through Self-Help Group (A study in sri vinayaka women self-help group)" at Muninagra village Kaggalahalli Grama, harohalli hobali, kanakapura thaluku , Ramanagara district 562112, under our guidance**

**We wish her all the best and success in all her future endeavors.**

**Warm regards,**

**PROPRIETOR**

**MAMATHA J.K**

*[Handwritten Signature]*  
**PRINCIPAL**  
**The National College**  
**Jayanagar, Bangalore-70**

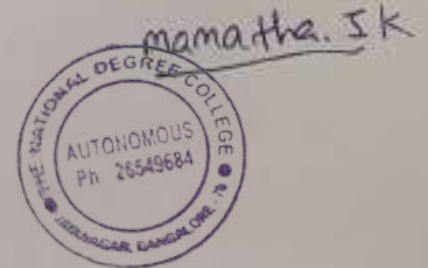





F5, 5th Floor -4 &  
5, Pinnacle Business Park,  
MahaKali  
Caves Road,  
Andheri (East),  
Mumbai-  
400093, India.  
[www.delex.in](http://www.delex.in)

Delex Cargo India Private Limited

## INTERNSHIP COMPLETION CERTIFICATE

This is to certify that YUVARAJ M Reg No.20NCJC904 B.COM Final Year student of The National College, Autonomous, Jayanagar, Bangalore has successfully completed internship of six weeks under the guidance of JYOTHI PRASAD at this organization, towards the fulfillment of the award of 'Bachelor of Commerce' during the year 2022-23.

During the period of his/her internship he/she has exhibited punctuality and diligence. We wish his/her every success in life.

DATE :21/11/2022

Thankyou

Your regards,

JYOTHI PRASADTS



Operation manager

PRINCIPAL

The National College  
Jayanagar, Bangalore-70





## Aghanta Retail Pvt. Ltd.

Corporate Office: 237 1<sup>st</sup> Floor Patil Business Center, RMV Extension, Dr. C.V. Raman Road,  
Sadashivanagar Bengaluru 56  
www.alpineaapl.com

### PROJECT COMPLETION LETTER

#### TO WHOMSOEVER IT MAY CONCERN

This is to certify that Mr. Yuvaraj M bearing Reg. No. 20NCIC904 of VI Semester B.Com student, The National College, Autonomous, Jayanagar, Bangalore has successfully completed the project work for the period of 06 weeks 24<sup>th</sup> April 2023 to 27<sup>th</sup> May 2023 under the guidance of Mr. Vinay Kumar R Marketing Manager at our organization towards the fulfillment of award of "Bachelor of Commerce" during the year 2022-23.

The title of his project work was: - Marketing strategies of the products.

During the period of his project with us he has exhibited punctuality and diligence. We wish him every success in life.

Thanking you.

For and on behalf of Aghanta Retail PVT Limited.

Mr. Vinay Kumar R

Marketing Manager.

Aghanta Retail Pvt. Ltd.  
Alpine Viva Owners Welfare  
Association (AVOWA)

S.No. 139, Whitefield, Hoskote Road  
Sai Gardens, Seegehalli  
Krishnarajapura, Bangalore-560 047

PRINCIPAL  
The National College  
Jayanagar, Bangalore-70.







Reg: 403

Date: 23-11-2022

## CERTIFICATE OF COMPLETION

This is to certify that Shreyas G, a student from National College Jayanagar, has interned with Samarathanam Trust for the Disabled from 7<sup>th</sup> October 2022 to 21<sup>st</sup> November 2022.

The student has successfully completed the work. He has worked in the HR department to understand the organization structure, How NGOs work, and to gain knowledge on the HR department along with other department information.

We found him responsible, efficient and their conduct during the internship was satisfactory. We found him sincere throughout the whole period and we wish him all the best in his future endeavors.

This organization is a registered NGO - Trust working towards the education, empowerment of persons with visual impairment, other disabilities, and underprivileged people through various developmental activities aided by technically assistive devices and to create an inclusive and indiscriminate society for them.

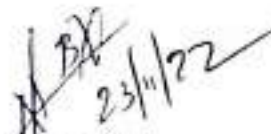
  
23/11/22  
Naveen B V  
Lead Volunteer



  
PRINCIPAL  
The National College  
Jayanagar, Bangalore-70.



**PROJECT COMPLETION LETTER**

**TO WHOMSOEVER IT MAY CONCERN**

This is to certify that Mr. Shreyas G bearing Reg. No. 20NCJC903 of VI Semester B.Com student, The National College, Autonomous, Jayanagar, Bangalore has successfully completed the project work from 13<sup>th</sup> April 2023 to 18<sup>th</sup> May 2023 under the guidance of Akash Gadiya, Director at our organisation towards the fulfilment of award of "Bachelor of Commerce" during the year 2023-24.

The title of his project work was Digital Marketing in Healthcare.

During the period of his project with us he has exhibited punctuality and diligence. We wish him every success in life.

Thanking you.

For Novalife Healthcare

For **NOVALIFE HEALTHCARE**

18/05/23.  
Authorised sign **Proprietor**

*[Signature]*  
**PRINCIPAL**  
**The National College**  
Jayanagar, Bangalore-70.





## INTERNSHIP COMPLETION CERTIFICATE

This is to certify that Ms. Savitha Bai M, Reg No.20NCJC901 B.Com Final Year student of The National College, Autonomous, Jayanagar, Bangalore has successfully completed internship on Recruitment and Documentation from 10-10-2022 to 09-11-2022 under the guidance of JAGADISH C [HR Manager ] in Sangeetha Mobiles Pvt Ltd, towards the fulfillment of the award of 'Bachelor of Commerce' during the year 10 Oct 2022 to 9 Nov 2022.

During the period of her internship, she has exhibited punctuality and diligence. We wish her every success in life.

Yours Sincerely,  
For Sangeetha Mobiles Pvt. Ltd.

For Sangeetha Mobiles Pvt. Ltd.

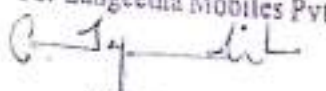
  
Authorized Signatory

Jagadish C  
HR Manager

  
PRINCIPAL  
The National College  
Jayanagar, Bangalore-70



**Sangeetha Mobiles Private Limited**

Head Office : # 1183, 22nd 'A' Cross, Banashankari 2nd Stage, Bangalore-560 070.

Tel. : 080-4939 7000 / 080-4939 7111 [www.sangeethamobiles.com](http://www.sangeethamobiles.com)



# A. K. HEALTH CARE

Distributors for Health Care Medical Electronic Products

# 49/10(A), 2nd Floor, 1st Cross, Roshan Colony, Jayanagar, Bangalore - 560 041  
Mobile : 98457 60444

Date : .....

## PROJECT COMPLETION LETTER

### TO WHOMSOEVER IT MAY CONCERN

This is to certify that Mr. Shaik Shazar bearing Reg. No. 20NCJC902 of VI Semester B.Com student, The National College, Autonomous, Jayanagar, Bangalore has successfully completed the project work for the period of 06 weeks from 01/05/2023 -14/05/2023 , under the guidance of Satish BK , Manager at our organisation towards the fulfilment of award of "Bachelor of Commerce" during the year 2023-24.

The title of his project work was Budgetary Control.

During the period of his project with us he has exhibited punctuality and diligence. We wish him every success in life.

Thanking you.

AK HEALTH CARE PVT.LTD

**A K HEALTH CARE**  
Shop No.1 & 2 No. 1, 3rd Cross,  
Umar Bagh Laydūt, Jp Nagar Post  
Karakapura Main Road  
Bangalore-78

*Dr. Sush*  
PRINCIPAL  
The National College  
Jayanagar, Bangalore-70







Plot No.45 - 47, KIADB Industrial Area,  
Phase - II, Electronic City , Bengaluru - 560100  
(Karnataka) India: +91-80-6780778

**PROJECT COMPLETION LETTER**

**TO WHOMSOEVER IT MAY CONCERN**

This is to certify that Mr./ MS. SAVITHA BAI . M bearing Reg No. 20NCJC901 of VI Semester B.Com student, The National College, Autonomous, Jayanagar, Bangalore has successfully completed the project work for the period of 4 weeks (10/04/2023 -3/05/2023) under the guidance of (SAMYAM &MANAGER) at our organisation to wards the fuilfilment of award of "Bachelor of commerce " during the year 2023-2024.

The title of his/ her project work was  
**DATA ANALYSIS ADA DATA HANDLING UNDER IT COMPANY**  
During the period of her project with us she has exhibited punctuality and diligence.

We wish her every success in life.

Thanking You .

For, TECH MAHINDRA

For TECH MAHINDRA LIMITED

Authorised signatory(with company seal)  
**GEORGE MUNDASSERY**  
VICE PRESIDENT

  
PRINCIPAL  
The National College  
Jayanagar, Bangalore-70



## INTERNSHIP COMPLETION CERTIFICATE

This is to certify that Rakesh Singh Reg No. 20NCJC900, B.Com Final Year student of The National College, Autonomous, Jayanagar, Bangalore has successfully completed internship of six weeks under the guidance of Mr. Suresh M at this organization, towards the fulfillment of the award of 'Bachelor of Commerce' during the year 2022-23.

During the period of his internship, he has exhibited punctuality and diligence. We wish his every success in life.

Date: 28/11/2022

Place: Bangalore

SBI Credit Cards  
VP Customer Service Dept  
10th Floor, DLF Infinity Tower 'C'  
Block 2 Building 3, DLF Cyber City  
Gurgaon - 122002

  
PRINCIPAL  
The National College  
Jayanagar, Bangalore-70





**TO WHOMSOEVER IT MAY CONCERN**

This is to certify that **Mr. Rakesh Singh.N** bearing Reg No. **20NCJC900** of VI Semester B. Com, The National College, Autonomous, Jayanagar, Bangalore has successfully completed the project work for the period of 06 weeks starting from 27-03-2023 to 08-05-2023 under the guidance of Mr. Mukesh Singh at our organisation towards the fulfilment of award of "Bachelor of Commerce" during the year 2022-23.

The title of his/her project work was **OPERATION AND CLAIM PROCEDURE OF MOTOR VEHICLE INSURANCE.**

During the period of his project with us he has exhibited punctuality and diligence. We wish him every success in life.

Thanking you.

**MUKESH SINGH**

For I T 9 Technology Pvt. Ltd.



Authorized Signatory

**OTO CAPITAL.**

  
**PRINCIPAL**  
The National College  
Jayanagar, Bangalore-70.

  
**1 T 9 TECHNOLOGY Pvt. Ltd.**  
# 71, 3rd Cross,  
MICO LAYOUT, JAYNAGAR  
BANGALORE - 560040

TIN : 29440208029  
GSTIN : 29ALIPK7776Q12W



Mob: 9739710814

# ARUNACHALAM TRADERS

Dealers in : Wholesale & Retail Tea Powder, Suppliers of Assam, Darjiling, Nilgiri Tea & Spices  
# 6, Old Tharagupet Cross, G.S. Market, 1st Floor, Bangalore-560 053.

Ref:

Date.....

## INTERNSHIP COMPLETION CERTIFICATE

This is to certify that POOJA E Reg No.20NCJC899 B.Com Final Year student of The National College, Autonomous, Jayanagar, Bangalore has successfully completed internship of six weeks under the guidance of - PREM KUMAR at ARUNACHALAM TRADERS organisation, towards the fulfilment of the award of 'Bachelor of Commerce' during the year 2022-23.

During the period of her internship she has exhibited punctuality and diligence. We wish her every success in life.

For ARUNACHALAM TRADERS

V.S. Idanag  
Proprietor

(Authorised signature with seal)

Date: 12-01-2023

Place: BANGALORE

*[Handwritten Signature]*

PRINCIPAL

The National College  
Jayanagar, Bangalore-70







# AKSHAY CERAMIC

**Manufacturers of Mosaics**

*Vetrified, Ceramic Tiles, Granite & Sanitary Fittings*

No. 25/6, Hommadevanahalli Village, Gottigere Post, Bannerghatta Road, Bangalore - 560 083



Date: 23-05-2023

## PROJECT COMPLETION LETTER

### TO WHOMSOEVER IT MAY CONCERN

This is to certify that Miss. Pooja.E bearing Reg.No. 20NCJC899 of VI Semester B.Com student, The National College, Autonomous, Jayanagar, Bangalore has successfully completed the project work for the period of 06 weeks 11-04-2023 to 22-05-2023 under the guidance of M.Satish Kumar (Manager) at our organisation towards the fulfilment of the award of "Bachelor of Commerce" during the year 2021-22.

The title of his project work was "A study on impact of implementation of GST across manufacturing concern."

During the period of his project with us he has exhibited punctuality and diligence. We wish her every success in life.

Thanking you.

From,  
Akshay Ceramic

Authorised signatory

*S. Satish Kumar*  
PRINCIPAL  
The National College  
Jayanagar, Bangalore-70



03-11-2022

To,  
Dr. N K Satya Pal Sharma  
HOD- Department of Commerce  
The National College  
Autonomous  
Jayanagar, Bangalore-70

Dear Sir,

Subject: Internship Acceptance Letter- Kavya shree s 20NCJC898

This is to certify that Ms. Kavya shree s Reg No. 20NCJC898 has joined in our organisation on 07-10-2022 and she will be working as internship trainee in Mukta A2 Cinemas for the period of 45 days.

Thanking you



*[Handwritten Signature]*  
PRINCIPAL  
The National College  
Jayanagar, Bangalore-70



**MUKTA A2 CINEMAS LIMITED**

Regd. Office: Mukta House, Behind Whistling Woods Institute, Filmcity Complex, Goregaon (East), Mumbai – 400065  
Telephone No. : (022) 33649400 | Fax No. - (022) 33649401 | CIN: U74999MH2016PLC287694  
www.muktaa2cinemas.com | Follow us on /muktaA2cinemas



## TO WHOMSOEVER IT MAY CONCERN

This is to certify that Miss KAVYA SHREE.S bearing Reg. No.20NCJC898 of VI Semester B. Com student, The National College, Autonomous, Jayanagar, Bangalore has successfully completed the project work for the period of 04 weeks 16-04-2023 TO 16-05-2023 under the guidance of Mrs. Pooja, Human Resource at our organization towards the fulfilment of award of "Bachelor of Commerce" during the year 2022-23.

The title of her project work was " Human resource operation at ITC welcome hotel ".

During the period of her project with us she has exhibited punctuality and diligence. We wish her every success in life

Thanking You.

Authorized signatory company seal



*[Signature]*  
PRINCIPAL

The National College

Welcomhotel by ITC Hotels, Richmond Road, Bengaluru #46, Richmond Rd, Victoria  
Layout, Bengaluru, Karnataka 560025





**ACCEPTANCE LETTER**

Date: 10/10/2022

To  
Dr. N K Satya Pal Sharma  
HOD- Department of Commerce  
The National College Autonomous  
Jayanagar, Bangalore- 70

Dear Sir,

**Subject: Internship Acceptance Letter – Mr. Aman Kumar Singh. G - 20NCJC894**

This is to certify that **Mr. Aman Kumar Singh. G Reg. No.20NCJC894** has joined in our organization on **10-10-2022** and he will be working as internship trainee in **Reliance Trends - Marketing Department** from **10-10-2022 to 14-11-2022**

Thanking You

Sincerely yours,

For Reliance Trends

  
**RELiance RETAIL LIMITED**  
Bhartiya City Centre, Thanisandra,  
Bangalore, Karnataka - 560 077

  
PRINCIPAL  
The National College  
Jayanagar, Bangalore-70





# Swemed Biomedicals Pvt. Ltd.

## TO WHOMSOEVER IT MAY CONCERN

This is to certify that Mr. Aman Kumar Singh.G, bearing Reg.No. 20NCJC894 of VI Semester B.Com student, The National College, Autonomous, Jayanagar, Bangalore has successfully completed the project work for the period of 6 weeks, From 17/04/2023 to 20/05/2023 under the guidance of (HR MANAGER, KUMAR SHARMA) at our organisation towards the fulfilment of award of "Bachelor of Commerce" during the year 2022-23.

The title of his project work was Sales promotion towards social media marketing

During the period of his project with us he has exhibited punctuality and diligence. We wish his every success in life.

Thank you,

For,  
Swemed Biomedicals Pvt. Ltd

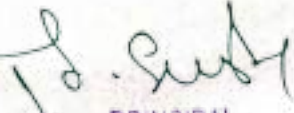
  
PRINCIPAL  
The National College  
Jayanagar, Bangalore-70.

SWEMED BIOMEDICALS PVT. LTD

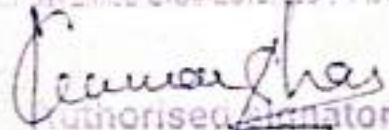
  
Authorised Signatory



CIN U31909KA2003PTC032979

29/1 first floor, Chunchanaghatta Cross, Yelachenahalli, Bengaluru 560062-08026551720

## INTERNSHIP COMPLETION CERTIFICATE

This is to certify that PAVAN RAO Reg No.20NCJC893 B.Com Final Year student of The National College, Autonomous, Jayanagar, Bangalore has successfully completed internship of six weeks under the guidance of -Samiksha at EKKI PUMPS organisation, towards the fulfilment of the award of 'Bachelor of Commerce' during the year 2022-23.

During the period of her internship she has exhibited punctuality and diligence. We wish her every success in life.

For EKKI PUMPS

  
Authorised Signatory

(Authorised signature with seal)

Date: 12/01/2023

Place: BANGALORE

  
PRINCIPAL  
The National College  
Jayanagar, Bangalore-70





Date: 23/05/2023

PROJECT COMPLETION LETTER  
TO WHOMSOEVER IT MAY CONCERN

This is to certify that Mr. Pavan Rao R has been associated with our Organization as an Intern for the tenure from 11-04-2023 to 22-05-2023.

During the aforementioned tenure, Mr. Pavan Rao R remained engaged in his work with competence and sincerity. We found him able and efficient in executing all assigned tasks. He was found diligent, hardworking & Inquisitive.

We wish him all the best in his future endeavors.

Yours Cordially

For Neil Patel Digital India

B. Vinay Kumar

Authorized Signatory

*[Signature]*  
PRINCIPAL  
The National College  
Jayanagar, Bangalore-70



## INTERNSHIP COMPLETION CERTIFICATE

This is to certify that Ms. Likitha V, Reg No.20NCJC892 B.Com Final Year student of The National College, Autonomous, Jayanagar, Bangalore has successfully completed internship on Recruitment and Documentation from 10-10-2022 to 09-11-2022 under the guidance of JAGADISH C [HR Manager ] in Sangeetha Mobiles Pvt Ltd, towards the fulfillment of the award of 'Bachelor of Commerce' during the year 10 Oct 2022 to 9 Nov 2022.

During the period of her internship, she has exhibited punctuality and diligence. We wish her every success in life.

Yours Sincerely,  
For Sangeetha Mobiles Pvt. Ltd.

For Sangeetha Mobiles Pvt. Ltd.

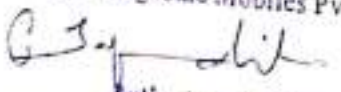
  
Authorized Signatory

Jagadish C  
HR Manager

  
PRINCIPAL  
The National College  
Jayanagar, Bangalore-70



**Sangeetha Mobiles Private Limited**

Head Office : # 1183, 22nd 'A' Cross, Banashankari 2nd Stage, Bangalore-560 070.  
Tel. : 080-4939 7000 / 080-4939 7111 [www.sangeethamobiles.com](http://www.sangeethamobiles.com)

Karnataka | Andhra Pradesh | Telangana | Tamil Nadu | Puducherry | Gujarat | Uttar Pradesh



## InPAT pro Private Limited

CIN U80100KA2017PTC107434

(Formerly known as G-MaC Advisors Expert Accountants Pvt. Ltd.)

Head Office:

#142/143, 3rd Floor, GR Plaza, DVG Road, Gandhi Bazaar,  
Basavanagudi, Bengaluru, Karnataka 560004

### TO WHOMSOEVER IT MAY CONCERN

This is to certify that **Ms. LIKITHA V** bearing Reg. No. 20NCJCR92 of VI Semester B.Com student, The National College, Autonomous, Jayanagar, Bangalore has successfully completed the project work for the period of 04 weeks (**07-04-2023 to 06-05-2023**) under the guidance of (**Sudeep Singh M D, Manager**) at our Organization towards the fulfillment of award of "Bachelor of Commerce" during the year 2022-23

The title of her project work was **HR BUSINESS DEVELOPMENT OPERATIONS IN InPAT pro PVT LTD.**

During the period of her project with us she has exhibited punctuality and diligence. We wish her great success in her future endeavours.

For and on behalf of InPAT pro Private Limited

Shashikala Shetty

Director



PRINCIPAL

The National College  
Jayanagar, Bangalore-70





## INTERNSHIP COMPLETION CERTIFICATE

This is to certify that Mr.JAYANTH R NAIK, Reg No.20NCJC891, B.Com Final Year student of The National College, Autonomous, Jayanagar, Bangalore has successfully completed internship of 11 days under the guidance of Mr Ashok Savanth (Store Manager)at this organization (*Tanishq Bannerghatta Road*), towards the fulfillment of the award of '*Bachelor of Commerce*' during the year 2022-23.

During the period of his/her internship he/she has exhibited punctuality and diligence. We wish his/her every success in life.

  
(Authorized signature with seal)



Date:

Place:

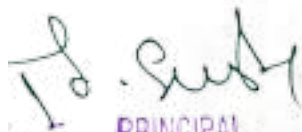
  
PRINCIPAL  
The National College  
Jayanagar, Bangalore-70



**PROJECT COMPLETION LETTER**

Date: 16/06/2023

**TO WHOMSOEVER IT MAY CONCERN**

This is to certify that Mr. Jayanth R Naik bearing Reg. No. 20NCJC891 of VI Semester B.Com student, The National College, Autonomous, Jayanagar, Bangalore has successfully completed the project work for the period of 04 weeks 15/05/2023 to 15/06/2023 under the guidance of (Sindhu & HR Manager) at our organisation towards the fulfilment of award of "Bachelor of Commerce" during the year 2021-22.

The title of his project work was: **Leadership styles and its impacts.**

During the period of his project with us he has exhibited punctuality and diligence. We wish him every success in life.

Thanking you.

**Katpro Technology.**



*Moozo*

Authorised signatory (with company seal)

**Katpro Technologies Pvt. Ltd.**  
Grand #444, 2nd Floor, 15th  
5th Main, HSR Sector 6,  
Bangalore - 560102, Karnataka  
[www.katprotech.com](http://www.katprotech.com)

*S. Sindhu*  
PRINCIPAL  
The National College  
Jayanagar, Bangalore-70



## INTERNSHIP COMPLETION CERTIFICATE

This is to certify that Mr.HARSHITH R, Reg No.20NCJC890, B.Com Final Year student of The National College, Autonomous, Jayanagar, Bangalore has successfully completed internship of 11 days under the guidance of Mr Ashok Savanth (Store Manager)at this organization (*Tanishq Bannerghatta Road*), towards the fulfillment of the award of '*Bachelor of Commerce*' during the year 2022-23.

During the period of his/her internship he/she has exhibited punctuality and diligence. We wish his/her every success in life.

  
(Authorized signature with seal)



Date:

Place:

  
PRINCIPAL  
The National College  
Jayanagar, Bangalore-70.





Ref:

Date: 16/06/2023

## PROJECT COMPLETION LETTER

### TO WHOMSOEVER IT MAY CONCERN

This is to certify that Mr. Harshith R bearing Reg. No. 20NCJC890 of VI Semester B.Com student, The National College, Autonomous, Jayanagar, Bangalore has successfully completed the project work for the period of 04 weeks 15/05/2023 to 15/06/2023 under the guidance of Mr. Manjunath (Company Manager) at our organisation towards the fulfilment of award of "Bachelor of Commerce" during the year 2021-22.

The title of his project work was: **Employee motivation.**

During the period of his project with us he has exhibited punctuality and diligence. We wish him every success in life.

Thanking you.

D E Shaw & Co.



Authorised signatory (with company seal)

  
PRINCIPAL  
The National College  
Jayanagar, Bangalore-70.





# RAJNANDINI HOSPITAL

No. 3, 6th Cross, Old Bank Colony, Konanakunte, Bangalore - 560 062.

Hosp : 7829090239

Ph : 26320140

26323778

E-mail : info@rajnandini-hospital.com

DATE :

## INTERNSHIP COMPLETION CERTIFICATE

This is to certify that VIVEK.A, REG: 20NCJC888, B. Com Final Year student of The National College, Autonomous, Jayanagar, Bangalore has successfully completed internship of Six weeks under the guidance of Dr. Rajeev Loomba at Rajnandini Hospital, towards the fulfilment of the award of 'Bachelor of the commerce' during the year 2022-23.

During the period of his internship, he has exhibited punctuality and diligence. We wish his every success in life.

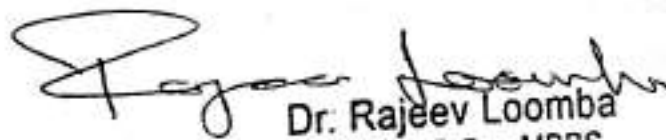
  
Dr. Rajeev Loomba

B.Sc., MBBS..

KMC Reg No. 33151

RAJNANDINI HOSPITAL

#3, 6TH CROSS, OLD BANK COLONY

KONANAKUNTE, BANGALORE - 62

PH : 26320140 26323778

PRINCIPAL

The National College  
Jayanagar, Bangalore-70.



Date:

Place:



TO WHOMSOEVER IT MAY CONCERN

This is to certify that Mr. VIVEK.A bearing REG.NO 20NCJC888 of VI semester B.com student, The National college, Autonomous, Jayanagar, Bangalore has successfully completed the project work for the period of 4 Weeks under the guidance of Ms. MONISHA SHETTY (H.R) at our organisation towards the fulfilment of award of "Bachelor of commerce" during the year 2021-22.

The title of his/her project work was *Project Report on QR Code in Amazon*

During the period of his/her project with us he/she has exhibited punctuality and diligence. we wish him/her every success in life.

Thanking you.

for, (company name)



*Dr. Sudh*  
PRINCIPAL  
The National College  
Jayanagar, Bangalore-70.



Authorised signatory with company seal



## INTERNSHIP COMPLETION CERTIFICATE

This is to certify that Ms.Vasundhara Kondapaku, Register No.20NCJC887, B.com Final Year student of The National College, Autonomous, Jayanagar, Bangalore has Successfully Completed Internship of 10 days Under the Guidance of At Tanishq Caratlane Jayanagar, Towards the fulfillment of the award of 'Bachelor of Commerce' during the year of 2022 - 23.

During the period of her internship she exhibited punctuality and diligence. We wish her every success in life.

Date :02/11/2022

Place:Bangalore

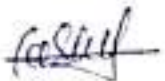

Hr-Executive

Tanishq Jayanagar

For SRSV AGRO COMPANY

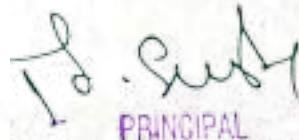

PRINCIPAL

The National College  
Jayanagar, Bangalore-70



Partner



TO WHOMSOEVER IT MAY CONCERN

This is to certify that Ms.VASUNDARA.K.S bearing REG.NO 20NCJC887 of VI semester B.com student, The National college, Autonomous, Jayanagar, Bangalore has successfully completed the project work for the period of 4 Weeks under the guidance of Ms. MONISHA SHETTY (H.R) at our organisation towards the fulfilment of award of "Bachelor of commerce" during the year 2021-22.

The title of his/her project work was *project report on Duplicate selection in amazon audit.*

During the period of his/her project with us he/she has exhibited punctuality and diligence.we wish him/her every success in life.

Thanking you.

for, (company name)



*Ms. Shetty*  
PRINCIPAL  
The National College  
Jayanagar, Bangalore-70



Authorised signatory with company seal



Mc Donlads Pvt Ltd

Date:28/09/2022

To  
Head of the Department of Commerce  
The National Degree College  
7<sup>th</sup> Block, Jayanagar  
Bangalore-560070

Dear Sir/ Madam

**Sub:- Permission For Internships.**

With reference to your letter, We are pleased to permit **Mr.Supreeth N K, Reg No. 20NCJC885** Student of **B.com** from your College to undergo his Internship in our organization from **28-09-2022 to 12-11-2022.**

As this internship is a part of course curriculum the information gathered during his association with us has to be used for a academic purpose only.

Thanking You,

Mcdonald's India, Bangalore

**KISHOR**

**MCDONALDS ASSISTANT MANAGER**

 .124  
Banashankari Bangalore  
Hardcastle Restaurants Pvt. Ltd  
#2466, 2nd Cross, Opp. BDA Complex  
Banashankari, 2nd Stage, Bangalore - 560070.  
Manager Name:.....  
Manager Signature:.....  
Ph. No. 080 - 42005285

*To Supreeth*  
PRINCIPAL  
The National College  
Jayanagar, Bangalore-70





Estd. 1916



# The Comptroller's Office Co-operative Bank Ltd.,

(A Bank of LIC Employees)

'Mahalakshmi', No. 209  
Cubbonpet Main Road  
Bangalore - 560 002  
Ph : 22216820, 22278462  
Email : cocb1916@gmail.com  
Website : www.cocb1916.com

Ref.: COCB/

Date :

Ref No.: COCB/253/2022-23

15<sup>th</sup> December 2022

## INTERNSHIP COMPLETION CERTIFICATE

This is to certify that SPOORTHI. R., Ref No. 20NCJC 884, B Com Final Year Student of The National College, Autonomous, Jayanagar, Bangalore has successfully completed internship of six weeks under the guidance of LAKSHMI N at this organization, towards fulfillment of the award of 'Bachelor of Commerce' during the year 2022-23

During the period of her internship she has exhibited punctuality and diligence. We wish her success in life.

Place: Bangalore

*Lakshmi*  
(Authorised signature with seal)

**N. LAKSHMI**  
Chief Manager / CEO



*S. Sush*  
PRINCIPAL  
The National College  
Jayanagar, Bangalore-70





**PROJECT COMPLETION LETTER  
TO WHOMSOEVER TI MAY CONCERN**

This is to certify that Mr./ Ms. Spoorthi R bearing Reg. No 20NCJC884 of B. Com VI Semester of the National College, Autonomous, Jayanagar, Bangalore has successfully completed the project work for the period of 4 weeks (10/04/2023-03/05/2023) under the guidance of (ABHISHEK & MANAGER) at our organization towards the fulfillment of award of "Bachelor of commerce" during the year 2023-2024.

The title of his/her project work was

**A STUDY ON ORGANIZATION BEHAVIOR.**

During the period of her project with us she has exhibited punctuality and diligence.

We wish her every success in life.

Thanking you.

For, EUREKA FORBES

Authorized signatory (with company seal)

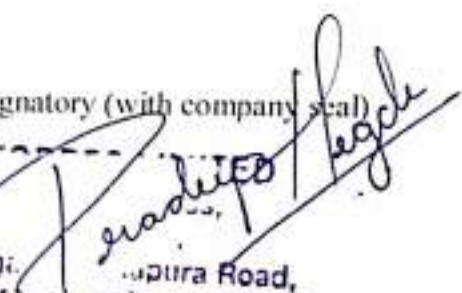
  
EUREKA FORBES  
#1014, 2nd  
1st Main, No  
S: ...hi Nagi, ...ptira Road,  
T: ...gattapura, Bangalore - 560062  
C: 6147

  
Eureka-Forbes Limited

CIN: U27109WB1931PLC007010 Phone: (033) 3049 2534

Registered Office: 7, Chakra Beria Road, (South) Kolkata - 700025



19<sup>th</sup> Jul 2023

**TO WHOMSOEVER IT MAY CONCERN**

This is to certify that **Ms. Sinchana S Hegde**, a student of **The National College Autonomous, Jayanagar, Bangalore**. Pursuing **B. COM** has successfully completed the project with **Careernet Technologies Pvt. Ltd.**, for academic purposes.

**Below are the details of the project:**

Project Title: **Digital Hiring Process**

Project Duration: **22<sup>nd</sup> May 2023 to 13<sup>th</sup> Jun 2023**

We appreciate the efforts made by her for the project and extend our best wishes for her future endeavors.

For **Careernet Technologies Pvt. Ltd.**

**KAVITHA S**  
Digitally signed by KAVITHA S  
Date: 2023.07.20 17:02:31  
+05'30'

**Kavitha S**  
Vice President -HR

**CONFIDENTIAL**

*[Handwritten Signature]*  
**PRINCIPAL**  
**The National College**  
**Jayanagar, Bangalore-70**

Corporate Office: Careernet Technologies Pvt. Ltd.  
Plot No 53, Kanyammana Agrahara Road, Devarabeesanahalli,  
Outer Ring Road, Bellandur Post, Bengaluru, 560103  
careernet.in







ದಿ ಮೈಸೂರ್ ಎಲೆಕ್ಟ್ರಿಕಲ್ ಇಂಡಸ್ಟ್ರೀಸ್ ಲಿಮಿಟೆಡ್

(ಕರ್ನಾಟಕ ರಾಜ್ಯ ಸರ್ಕಾರದ ಉದ್ಯಮ)

CIN NO. U85110KA1945SGC00037

THE MYSORE ELECTRICAL INDUSTRIES LIMITED  
(Government of Karnataka Undertaking)

REF: MEI/PER/02/F-343/2023

DATE : 02.05.2023

CERTIFICATE

This is to certify that Mr. SHISUVENK K B student of final year B.com bearing Reg No.:20NCJC882, student of The National College Autonomous Jayanagar, Bengaluru, affiliated to Bangalore University, Bangalore, he has successfully completed his Project in The Mysore Electrical Industries Limited starting from 1-4-2023 to 1-5-2023 at The Mysore Electrical Industries Limited, Bengaluru. During the period of his project with us he was found punctual, hardworking and his character was satisfactory.

This program on evaluation fulfils all the stated criteria. We wish him all the best.

For the Mysore Electrical Industries Limited.,

  
General Manager (A & HR)  
Deputy General Manager  
(Finance & Accounts)  
MEI Ltd., Bangalore

  
PRINCIPAL  
The National College  
Jayanagar, Bangalore-70



ರಿಜಿಸ್ಟರ್ಡ್ ಅಫೀಸ್ : ತುಮಕೂರು ರಸ್ತೆ, ಯಶವಂತಪುರ, ಬೆಂಗಳೂರು-56 0022. REGD OFFICE: TUMKUR ROAD, YESHWANTHIPURA, BANGALORE-560 022 ದೂರವಾಣಿ / Phone 91-080-23374851 (6 Lines) 91-080-23386641 (3 Lines) ಫ್ಯಾಕ್ಸ್ / Fax: 91-080-23381811 ಅಂಚೆ ಪೆಟ್ಟಿಗೆ ಸಂಖ್ಯೆ / Post Box No. 2221 / ಬೆಂಗಳೂರು/BANGALORE-5600223 ಭಾರತ/ INDIA Email meimd@rediffmail.com, meilmatis9@gmail.com, meimktg@rediffmail.com

Visit us at [www.meiswitchgears.org](http://www.meiswitchgears.org)



ದಿ ಮೈಸೂರ್ ಎಲೆಕ್ಟ್ರಿಕಲ್ ಇಂಡಸ್ಟ್ರೀಸ್ ಲಿಮಿಟೆಡ್

(ಕರ್ನಾಟಕ ರಾಜ್ಯ ಸರ್ಕಾರದ ಉದ್ಯಮ)

CIN NO. U85110KA1945SGC00037

THE MYSORE ELECTRICAL INDUSTRIES LIMITED  
(Government of Karnataka Undertaking)

REF: MEI/PER/02/F-343/2023

DATE : 02.05.2023

CERTIFICATE

This is to certify that Mr. SHISUVENK K B student of final year B.com bearing Reg No.:20NCJC882, student of The National College Autonomous Jayanagar, Bengaluru, affiliated to Bangalore University, Bangalore, he has successfully completed his Project in The Mysore Electrical Industries Limited starting from 1-4-2023 to 1-5-2023 at The Mysore Electrical Industries Limited, Bengaluru. During the period of his project with us he was found punctual, hardworking and his character was satisfactory.

This program on evaluation fulfils all the stated criteria. We wish him all the best.

For the Mysore Electrical Industries Limited.,

  
General Manager (A & HR)  
Deputy General Manager  
(Finance & Accounts)  
MEI Ltd., Bangalore

  
PRINCIPAL  
The National College  
Jayanagar, Bangalore-70



ರಿಜಿಸ್ಟರ್ಡ್ ಅಫೀಸ್ : ತುಮಕೂರು ರಸ್ತೆ, ಯಶವಂತಪುರ, ಬೆಂಗಳೂರು-56 0022. REGD OFFICE: TUMKUR ROAD, YESHWANTHIPURA, BANGALORE-560 022 ದೂರವಾಣಿ / Phone 91-080-23374851 (6 Lines) 91-080-23386641 (3 Lines) ಫ್ಯಾಕ್ಸ್ / Fax: 91-080-23381811 ಅಂಚೆ ಪೆಟ್ಟಿಗೆ ಸಂಖ್ಯೆ / Post Box No. 2221 / ಬೆಂಗಳೂರು/BANGALORE-5600223 ಭಾರತ/ INDIA Email meimd@rediffmail.com, meilmatis9@gmail.com, meimktg@rediffmail.com

Visit us at [www.meiswitchgears.org](http://www.meiswitchgears.org)



Studio  
Unathi

Studio  
Unathi

ARCHITECTURE . INTERIORS . LANDSCAPE

## INTERNSHIP COMPLETION CERTIFICATE

This is to certify that **SHASHANK. K** Reg No.20NCJC881, B.Com  
Final Year student of The National College, Autonomous, Jayanagar, Bangalore has  
successfully completed internship of six weeks under the guidance of -  
**Mr. Supreeth. K. M** at this organization, towards the fulfillment of  
the award of 'Bachelor of Commerce' during the year 2022-23.

During the period of his/her internship he/she has exhibited punctuality and  
diligence. We wish his/her every success in life.

Date: 4/10/2022

Place: Bangalore

*[Signature]*  
PRINCIPAL  
The National College  
Jayanagar, Bangalore-70





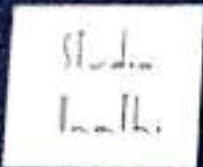

**Studio  
Unathi**

ARCHITECTURE . INTERIORS . LANDSCAPE

**PROJECT COMPLETION LETTER**

**TO WHOMSOEVER IT MAY CONCERN**

This is to certify that SHASHANK.K bearing Reg. No. 20NCJC881 of VI Semester B.Com student, The National College, Autonomous, Jayanagar, Bangalore has successfully completed the project work for the period of 04 weeks at STUDIO UNATHI under the guidance of Supreeth K. M at our organisation towards the fulfilment of the award of "Bachelor of Commerce" during the year 2023-24.

The title of his project work was "WORK LIFE BALANCE"

During the period of her project with us she has exhibited punctuality and diligence. We wish her every success in life.

Thanking you,

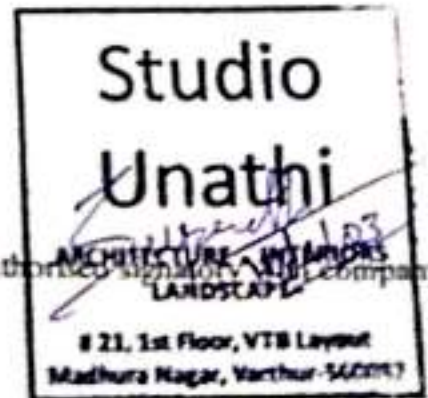

*[Signature]*  
PRINCIPAL  
The National College  
Jayanagar, Bangalore-70





MK FASHION

NO. 20, 21, 22, 23, 24, 25, 26, 27, 28, 29, 30, 31, 32, 33, 34, 35, 36, 37, 38, 39, 40, 41, 42, 43, 44, 45, 46, 47, 48, 49, 50, 51, 52, 53, 54, 55, 56, 57, 58, 59, 60, 61, 62, 63, 64, 65, 66, 67, 68, 69, 70, 71, 72, 73, 74, 75, 76, 77, 78, 79, 80, 81, 82, 83, 84, 85, 86, 87, 88, 89, 90, 91, 92, 93, 94, 95, 96, 97, 98, 99, 100  
PARK STREET, TORANANGALU ROAD, BANGALORE - 56002  
A/108/2008/111

Completion Certificate

This is to certify that **SARVAMANGALA TL Reg No.20NCJC879**, B.com Final year student of the National college, Autonomous, Jayanagar, Bangalore has successfully completed internship of six weeks under the guidance of MD Siddaraju at this organization, towards the fulfilment of the award of 'Bachelor of commerce' during the year 2022-23.

During the period of his/her internship he/she has exhibited punctuality and diligence. We wish his/her every success in life.

Authorized signature with seal

For M. K. FASHION

*Sidd*  
Proprietor

Date: 14/11/2022

Place: Bangalore

*S. Sridhar*  
PRINCIPAL  
The National College  
Jayanagar, Bangalore-70



**PROJECT COMPLETION LETTER**

**TO WHOMSOEVER IT MAY CONCERN**

This is to certify that Mr./Ms. SARVAMANGALA TL bearing Reg.No.20NCJC879 of VI Semester B. Com student, The National College, Autonomous, Jayanagar, Bangalore has successfully completed the project work for the period of 04 weeks (01/04/2023 – 28/04/2023) under the guidance of (SIDDARAJU K R & MANAGER) at our organisation towards the fulfilment of award of "Bachelor of Commerce" during the year 2023-24.

The title of his/her project work was

**A PROJECT REPORT ON LOANS AND SECURITY DOCUMENTATION IN FULLERTON INDIA CREDIT Co. Ltd.**

During the period of his/her project with us he/she has exhibited punctuality and diligence. We wish him/her every success in life.

Thanking you.

For, **FULLERTON INDIA CREDIT Co. Ltd.**

Fullerton India Credit  
Company Ltd



Authorised signatory with company seal

PRINCIPAL  
The National College  
Jayanagar, Bangalore-70





03-11-2022

To,  
Dr. N K Satya Pal Sharma  
HOD- Department of Commerce  
The National College  
Autonomous  
Jayanagar, Bangalore-70

Dear Sir,

Subject: Internship Acceptance Letter- Ramya shree R 20NCJC878

This is to certify that Ms. Ramya shree R Reg No. 20NCJC878 has joined in our organisation on 07-10-2022 and she will be working as internship trainee in Mukta A2 Cinemas for the period of 45 days.

Thanking you



*Dr. Sush*  
PRINCIPAL

The National College  
Jayanagar, Bangalore-70.

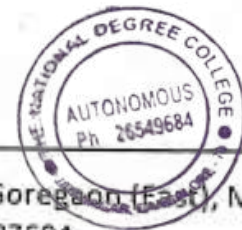

**MUKTA A2 CINEMAS LIMITED**

Head Office: Mukta House, Behind Whistling Woods Institute, Filmcity Complex, Goregaon (East), Mumbai - 400065  
Telephone No. : (022) 33649400 | Fax No. - (022) 33649401 | CIN: U74999MH2016PLC287694  
www.muktaa2cinemas.com | Follow us on  /muktaA2cinemas

**TO WHOMSOEVER IT MAY CONCERN**

This is to certify that Miss RAMYASHREE.R bearing Reg. No.20NCJC878 of VI Semester B.Com student, The National College, Autonomous, Jayanagar, Bangalore has successfully completed the project work for the period of 04 weeks 05-04-2023 TO 05-05-2023 under the guidance of Anjanappa V, Senior Talent Acquisition at our organisation towards the fulfilment of award of "Bachelor of Commerce" during the year 2022-23.

The title of her project work was "Work life balance and employee engagement activities".

During the period of her project with us she has exhibited punctuality and diligence. We wish her every success in life.

Thanking you.



Anji V  
Senior - TA & Campus Relation  
Bangalore & RoK  
Mobile +91 9611995988  
<http://www.byjus.com/>

  
PRINCIPAL  
The National College  
Jayanagar, Bangalore-70



THINK & LEARN PRIVATE LIMITED  
IBC KNOWLEDGE PARK, 4/12 FLOOR, TOWER D  
BANNERGHATTA MAIN ROAD, BENGALURU-  
560029, KARNATAKA  
E-MAIL: [INFO@BYJUS.COM](mailto:INFO@BYJUS.COM) / TEL NO: +91 80668 36800  
CIN U80903KA2011PTC061427  
[WWW.BYJUS.COM](http://WWW.BYJUS.COM)



DelexCargoIndiaPrivateLimited

E5, 5th Floor 4 B  
5,PinnacleBusinessPark,  
Mehakali CavesRoad,  
Andheri (East)  
Mumbai 400023,India.  
[www.delex.in](http://www.delex.in)

Acceptance letter

Date :10/10/2022

To,  
Dr.N K Sataya Pal Sharma  
HOD-Department of Commerce  
The National College  
Autonomous  
Jayanagar, Bangalore-70

DEAR Sir,

Subject : Internship ACCEPTANCE LETTER - Puneeth.J, 20NCJC877

This is to certify that Mr. Puneeth.JReg.No.20NCJC877 joined our organization on 4/10/2022 and he will be working as an internship trainee in our DELEX CARGO Private Limited For 45days.

Thankyou

Yourregards.

JYOTHIPRASADTS

Operationmanager



PRINCIPAL  
The National College  
Jayanagar, Bangalore-70.





**lenskart Solutions Pvt. Ltd.**

12/7, 7<sup>th</sup> Floor, Vastika Apartments, National Highway 3,  
Sector 27D, Faridkot, Haryana - 121003 | www.lenskart.com  
CN: U51494DL2008PTC178355



**PROJECT COMPLETION LETTER**

**TO WHOMSOEVER IT MAY CONCERN**

This is to certify that Mr./Ms. **PUNEETH J** bearing Reg. No. **20NCJC877** of VI Semester B.Com student, The National College, Autonomous, Jayanagar, Bangalore has successfully completed the project work for the period of 06 weeks (12/05/2023 to 23/06/2023) under the guidance of (**VINAY KUMAR J - Logistic Manager**) at our organisation towards the fulfilment of award of "Bachelor of Commerce" during the year 2022-23.

The title of his/her project work was **Forward and Reverse Logistics in Lenskart.**

During the period of his/her project with us he/she has exhibited punctuality and diligence. We wish him/her every success in life.

Thanking you.

For,

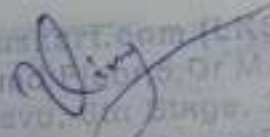
  
lenskart.com (2857850)  
Ground Floor, Dr. M.V. Road,  
Hulimavu, 1<sup>st</sup> Stage, 2<sup>nd</sup> Block  
BTM, Bangalore - 560078

Authorised signatory with company seal

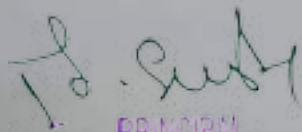
  
PRINCIPAL  
The National College  
Jayanagar, Bangalore-70





ದಿ ಮೈಸೂರ್ ಎಲೆಕ್ಟ್ರಿಕಲ್ ಇಂಡಸ್ಟ್ರೀಸ್ ಲಿಮಿಟೆಡ್

(ಕರ್ನಾಟಕ ರಾಜ್ಯ ಸರ್ಕಾರದ ಉದ್ಯಮ)

CIN NO. U85110KA1945SGC00037  
THE MYSORE ELECTRICAL INDUSTRIES LIMITED  
(Government of Karnataka Undertaking)

REF: MEI/PER/02/F-345/2023

DATE : 02.05.2023

CERTIFICATE

This is to certify that Mr. PRAVEEN K P student of final year B.com bearing Reg No.:20NCJC876, student of The National College Autonomous Jayanagar, Bengaluru, affiliated to Bangalore University, Bangalore, he has successfully completed his Project in The Mysore Electrical Industries Limited starting from 1-4-2023 to 1-5-2023 at The Mysore Electrical Industries Limited, Bengaluru. During the period of his project with us he was found punctual, hardworking and his character was satisfactory.

This program on evaluation fulfils all the stated criteria. We wish him all the best.

For the Mysore Electrical Industries Limited.,

*S. Jaffer KASH*  
General Manager (A & HR)  
Deputy General Manager  
(Finance & Accounts)  
MEI Ltd., Bangalore

*P. Sush*  
PRINCIPAL  
The National College  
Jayanagar, Bangalore-70.





ದಿ ಮೈಸೂರ್ ಎಲೆಕ್ಟ್ರಿಕಲ್ ಇಂಡಸ್ಟ್ರೀಸ್ ಲಿಮಿಟೆಡ್

(ಸರ್ಕಾರೀ ರಾಜ್ಯ ಸರ್ಕಾರದ ಉದ್ಯಮ)

CIN NO. U85110KA1945SGC00037  
THE MYSORE ELECTRICAL INDUSTRIES LIMITED  
(Government of Karnataka Undertaking)

REF: MEI/PER/02/F-345/2023

DATE : 02.05.2023

CERTIFICATE

This is to certify that Mr. PRAVEEN K P student of final year B.com bearing Reg No.:20NCJC876, student of The National College Autonomous Jayanagar, Bengaluru, affiliated to Bangalore University, Bangalore, he has successfully completed his Project in The Mysore Electrical Industries Limited starting from 1-4-2023 to 1-5-2023 at The Mysore Electrical Industries Limited, Bengaluru. During the period of his project with us he was found punctual, hardworking and his character was satisfactory.

This program on evaluation fulfils all the stated criteria. We wish him all the best.

For the Mysore Electrical Industries Limited.,

*S. Jai Prakash*  
General Manager (A & HR)  
Deputy General Manager  
(Finance & Accounts)  
MEI Ltd., Bangalore

*P. Susha*  
PRINCIPAL  
The National College  
Jayanagar, Bangalore-70





*SRV RETAIL*

Office : # 19, Platform Road  
Seshadripuram  
Bengaluru - 560 020  
Tel : 080-23566055

INTERNSHIP COMPLETION CERTIFICATE

This is to certify that Mr.PRATHAP L, Reg No.20NCJC875, B.Com Final Year student of The National College, Autonomous, Jayanagar, Bangalore has successfully completed internship of 12 days under the guidance of Mr Ashok Savanth (Store Manager)at this organization (*Tanishq Bannerghatta Road*), towards the fulfillment of the award of '*Bachelor of Commerce*' during the year 2022-23.

During the period of his/her internship he/she has exhibited punctuality and diligence. We wish his/her every success in life.

(Authorized signature with seal)

Date:

Place:

  
PRINCIPAL  
The National College  
Jayanagar, Bangalore-70



## INTERNSHIP COMPLETION CERTIFICATE

This is to certify that Ms.NIKITHA K, Reg No.20NCJC874, B.Com Final Year student of The National College, Autonomous, Jayanagar, Bangalore has successfully completed internship of 14 days under the guidance of Mr Ashok Savanth (Store Manager)at this organization (*Tanishq Bannerghatta Road*), towards the fulfillment of the award of '*Bachelor of Commerce*' during the year 2022-23.

During the period of his/her internship he/she has exhibited punctuality and diligence. We wish his/her every success in life.

  
(Authorized signature with seal)



Date:

Place:

  
PRINCIPAL  
The National College  
Jayanagar, Bangalore-70





HMT (International) Limited  
A Government of India Enterprise



## PROJECT COMPLETION LETTER

### TO WHOMSOEVER IT MAY CONCERN

This is to certify that Mrs. Nikitha K bearing Reg No. 20NCJC874 of VI Semester B.Com student, The National College, Autonomous, Jayanagar, Bangalore has successfully completed the project work for the period of 06 weeks from 08.04.2023 to 27.06.2023 Under Arun Kumar, Executive Head, at our organisation towards the fulfilment of award of "Bachelor of Commerce" during the year 2022-2023.

The title of her project work was Financial Performance analysis.

Her roles and responsibilities included that of Audit Associate. During the Project program with us she was found to be hardworking and efficient. We wish her lots of success in all her upcoming endeavours.

Thanking You.

HMT (International) Limited



Authorised signatory with company seal

*[Signature]*  
PRINCIPAL  
The National College  
Jayanagar, Bangalore-70.







## INTERNSHIP COMPLETION CERTIFICATE.

This is to certify that Mr. Mohan N Reg No. 20NCJC873 B.Com Final Year student of The National College, Autonomous, Jayanagar, Bangalore has successfully completed internship of six weeks under the guidance of Praveen Kumar (Technical architect) at this organization, towards the fulfillment of the award of 'Bachelor of Commerce' during the year 2022-23.

During the period of his internship he has exhibited punctuality and diligence. We wish his every success in life.

*[Handwritten signature]*



Date:  
Place:

*[Handwritten signature]*  
PRINCIPAL

Corporate Office: 11 B2, Lakshmi Krishna, 1st Floor, 1st Cross, Choolamedu, Choolamedu, Jayanagar, Bangalore-70.

Web: [eyefocus.com](http://eyefocus.com) Email: [info@eyefocus.com](mailto:info@eyefocus.com)



GSTIN : 29ABPFS9730F1ZK



Mob : 98803 02804  
98805 42001

## S.L.V. CORRUGATORS

**Manufacture of Heavy Duty Shlppor and Corrugated Boxes**

Survey no. 79, Near KRB Indian Oil Potori Pump, J.P.Nagar, 9 th Phase, Anjanapura Post,  
Bangalore - 560 108. Email : slv\_blr@hotmail.com

Ref.

PROJECT COMPLETION LETTER

Date : 29/04/2023

This is to certify that Mr. MOHAN N bearing Reg. No. 20NCJC873 of VI Semester B.Com student, The National College, Autonomous, Jayanagar, Bangalore has successfully completed the project work for the period of 04 weeks (03/04/2023 to 29/04/2023) under the guidance of RAMU S Manager at our organisation towards the fulfilment of award of "Bachelor of Commerce" during the year 2022-23.

The title of his project work was Supply chain management process.

During the period of his project with us he has exhibited punctuality and diligence. We wish him every success in life.

Thanking you.



Authorised signatory

PRINCIPAL  
The National College  
Jayanagar, Bangalore-70



## INTERNSHIP COMPLETION CERTIFICATE

This is to certify that **Ms. Meena.V**, Reg No. **20NCJC872**, B.Com Final Year student of The National College, Autonomous, Jayanagar, Bangalore has successfully completed internship on Recruitment and Documentation from 15/09/2202 to 30/10/2022 of under the guidance of **ABHISHEK**, in Eureka Forbes towards the fulfillment of the award of '*Bachelor of Commerce*' during the year **2022-23**.

During the period of his internship, he has exhibited punctuality and diligence. We wish his every success in life.

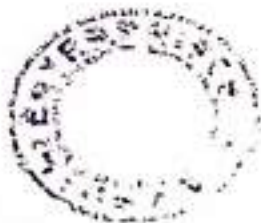

Yours Sincerely

*Abhi*  
**EUREKA FORBES LIMITED**  
#1014, 2nd Floor, 2nd Cross,  
1st Main, Near

*D. Sudh*  
**PRINCIPAL**  
**The National College**  
Jayanagar, Bangalore-70.







**TO WHOMSOEVER IT MAY CONCERN**

This is to certify that Ms.Meena, V bearing Reg.No. 20NCJC872 of VI Semester B.Com student, The National College, Autonomous, Jayanagar, Bangalore has successfully completed the project work for the period of 6 weeks, From 15/05/2023 to 17/06/2023 under the guidance of (JULIE GONSALVAS, MARKETING HEAD) at our organisation towards the fulfilment of award of "Bachelor of Commerce" during the year 2022-23.

The title of her project work was **Impact of branding on consumer purchasing behavior with Reliance Trends**

During the period of her project with us she has exhibited punctuality and diligence. We wish her every success in life.

Thank you.

For,

Reliance Trends

*Swamy*  
**RELiance RETAIL LIMITED**  
Bhartiya City Fr...  
Bangalore, Karnataka - 560 077  
PRINCIPAL  
The National College  
Jayanagar, Bangalore-70





F5, 5th Floor -4  
& 5, Pinnacle Business  
Park, Mahakali  
Caves Road,  
Andheri (East),  
Mumbai -  
400093, India.  
[www.delex.in](http://www.delex.in)

**Delex Cargo India Private Limited**

### INTERNSHIP COMPLETION CERTIFICATE

This is to certify that **MANJU H** Reg No.20NCJC871, B.COM Final Year student of The National College, Autonomous, Jayanagar, Bangalore has successfully completed internship of six weeks under the guidance of **JYOTHI PRASAD** at this organization, towards the fulfillment of the ward of 'Bachelor of Commerce' during the year 2022-23.

During the period of his/her internship he/she has exhibited punctuality and diligence. We wish his/her every success in life.

DATE: 21/11/2022

Thank you

Your regards,

JYOTHI PRASAD TS



Operation manager

PRINCIPAL

The National College  
Jayanagar, Bangalore-70





## PROJECT COMPLETION LETTER

### TO WHOMSOEVER IT MAY CONCERN

This is to certify that Mr. **MANJU H** bearing Reg. No. **20NCJC871** of VI Semester B.Com student, The National College, Autonomous, Jayanagar, Bangalore has successfully completed the project work for the period of 06 weeks (**20/04/2023 to 20/5/2023**) under the guidance of (**Sridhar GDM Dominos pizza**) at our organisation towards the fulfilment of award of "Bachelor of Commerce" during the year 2023-2024.

The title of his project work was Importance of brand choice attributes for dominos pizza.

During the period of his project with us he has exhibited punctuality and diligence. We wish him every success in life.

Thanking you.

Authorised signatory (Domino's Pizza)  
 Jubilant Foods Ltd Factory with No. 36  
 (DP67052) Ground Floor, Company seal  
 Horalur Main Road, Haralur Village  
 Off Sarjapur Main Road  
 Bangalore-560 102 Karnataka

*[Signature]*  
 PRINCIPAL  
 The National College  
 Jayanagar, Bangalore-70

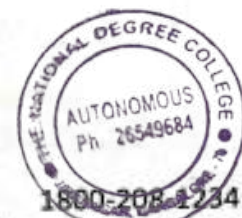

A Jubilant Bhartia company  
 Jubilant Foodworks Limited  
 Corporate office  
 5th floor, Tower-D plot No 5  
 Logix techno park, Sector-127,  
 Noida-201 304 UP India

1800-208-4234  
 guestcareDominos@jubilantfood.com



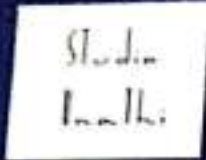

**Studio  
Unathi**

ARCHITECTURE . INTERIORS . LANDSCAPE

**ACCEPTANCE LETTER**

Date: 23/09/2022

To

Dr. N K Satya Pal Sharma

HOD- Department of Commerce

The National College

Autonomous

Jayanagar, Bangalore- 70

STudio

Dear Sir,

**Subject: Internship Acceptance Letter – MANOJ. H (20NCJC870)**

This is to certify that Mr./Ms. **MANOJ. H** Reg. No. **20NCJC870** has joined in our organisation on 23/09/2022 and he/she will be working as internship trainee in Studio Unathi for the period of 45 days.

Unathi

Thanking You

With Regards

From

Supreeth. K. M (General Manager)



Authorized Signature of Company's Seal

6/10/2022

*[Handwritten Signature]*

PRINCIPAL

#21, 1st Floor, VTB Layout, Manthura Nagar, Varthur-560087/ Contact: +91 9113252268  
The National College  
Jayanagar, Bangalore-70





ದಿ ಮೈಸೂರ್ ಎಲೆಕ್ಟ್ರಿಕಲ್ ಇಂಡಸ್ಟ್ರೀಸ್ ಲಿಮಿಟೆಡ್

(ಕರ್ನಾಟಕ ರಾಜ್ಯ ಸರ್ಕಾರದ ಉದ್ಯಮ)

CIN NO. U85110KA1945SGC00037

THE MYSORE ELECTRICAL INDUSTRIES LIMITED  
(Government of Karnataka Undertaking)

REF: MEI/PER/02/F-341/2023

DATE : 02.05.2023

CERTIFICATE

This is to certify that Mr. MANOJ H student of final year B.com bearing Reg No.:20NCJC870, student of The National College Autonomous Jayanagar, Bengaluru, affiliated to Bangalore University, Bangalore, he has successfully completed his Project in The Mysore Electrical Industries Limited starting from 1-4-2023 to 1-5-2023 at The Mysore Electrical Industries Limited, Bengaluru. During the period of his project with us he was found punctual, hardworking and his character was satisfactory. This program on evaluation fulfils all the stated criteria. We wish him all the best.

For the Mysore Electrical Industries Limited.,

  
S. JAI PRAKASH  
Deputy General Manager (A & HR)  
(Finance & Accounts)  
MEI Ltd., Bangalore

  
PRINCIPAL  
The National College  
Jayanagar, Bangalore-70.



ರಿಸರ್ಚ್ ಅಫೀಸ್ : ತುಮಕೂರು ರಸ್ತೆ, ಯಶವಂತಪುರ, ಬೆಂಗಳೂರು-56 0022 REGD OFFICE: TUMKUR ROAD,  
YESHWANTHPURA, BANGALORE-560 022 ದೂರವಾಣಿ / Phone 91-080-23374851 (6 Lines) 91-080-23386641  
(3 Lines) ಫ್ಯಾಕ್ಸ್ / Fax: 91-080-23381811 ಅಂಚೆ ಪೆಟ್ಟಿಗೆ ಸಂಖ್ಯೆ / Post Box No. 2221 / ಬೆಂಗಳೂರು/BANGALORE-5600223 ಖಾರಜ/  
INDIA Email meimd@rediffmail.com, mellmatis9@gmail.com, meimktg@rediffmail.com  
Visit us at www.meiswitchgears.org

## INTERNSHIP COMPLETION CERTIFICATE

This is to certify that Mr.MANOJ C, Reg No.20NCJC869, B.Com Final Year student of The National College, Autonomous, Jayanagar, Bangalore has successfully completed internship of 12 days under the guidance of Mr Ashok Savanth (Store Manager)at this organization (*Tanishq Bannerghatta Road*), towards the fulfillment of the award of '*Bachelor of Commerce*' during the year 2022-23.

During the period of his/her internship he/she has exhibited punctuality and diligence. We wish his/her every success in life.

(Authorized signature with seal)

Date:

Place:

  
PRINCIPAL  
The National College  
Jayanagar, Bangalore-70







This is to certify that **Mr. MANOJ.C** bearing Register No.20NCJC869, B.Com final year student, **The National College, Autonomous, Jayanagar, Bangalore** has successfully completed a Project of four weeks (from 15/04/2022 to 13/05/2022) under the guidance of (**Mr.RAHUL KULKARNI, STORE MANAGER**) at this outlet, towards the fulfillment of award of "Bachelor of Commerce" during the year 2022 – 2023.

The title of his project work was **CONSUMER PREFERENCE AND STORE IMAGE.**

During the period of his Project he has exhibited punctuality and diligence. We wish him/her every success in life.

Date :20/05/2023  
Place:Bangalore



Authorized Signature

  
PRINCIPAL  
The National College  
Jayanagar, Bangalore-70



AUTONOMOUS  
Ph 26549684



MK FASHION

MD SIDDARAJU CONSULTANTS & STUDY GUIDE  
PUBLISHED THROUGH ALL POSTS & AIR MAIL  
PHONE: 900111111

Completion Certificate

This is to certify that **LEELAMBIKE C** Reg No.20NCJC867, B.com Final year student of the National college, Autonomous, Jayanagar, Bangalore has successfully completed internship of six weeks under the guidance of MD Siddaraju at this organization, towards the fulfilment of the award of 'Bachelor of commerce' during the year 2022-23.

During the period of his/her internship he/she has exhibited punctuality and diligence. We wish his/her every success in life.

Authorized signature with seal

for M. K. FASHION

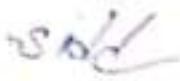
  
Proprietor

  
PRINCIPAL  
The National College  
Jayanagar, Bangalore-70



Date: 14/11/2022

Place: Bangalore

## TO WHOMSOEVER IT MAY CONCERN

This is to certify that Mr./Ms. LEEELAMBIKE C bearing Reg. No. 20NCJC867 of VI Semester B.Com student, The National College, Autonomous, Jayanagar, Bangalore has successfully completed the project work for the period of 06 weeks (03/04/2023 to 15/05/2023 ) under the guidance of RADHAKRISHINA RAO .K ( MANAGER ) at our organisation towards the fulfilment of award of "Bachelor of Commerce" during the year 2022-23

The title of his/her project work was A Project report on Logistics and warehouse management in Honeywell technology solutions.

During the period of his/her project with us he/she has exhibited punctuality and diligence. We wish him/her every success in life.

Thanking you.

For,

**HONEYWELL TECHNOLOGY SOLUTIONS LAB PVT LTD.**

*Radhakrishna*  
*J. Sush*  
Authorised signatory with company seal  
PRINCIPAL  
The National College  
Jayanagar, Bangalore-70





Date: 02/11/2022

**INTERNSHIP COMPLETION CERTIFICATE**

This is to certify that **Mr. T. KUSHAAL SIDDHA** Reg No. **20NCIC866**, B.Com Final Year student of The National College, Autonomous, Jayanagar, Bangalore has successfully completed internship of six weeks under the guidance of **SRIDHAR RAO S** at this organization, towards the fulfillment of the award of 'Bachelor of Commerce' during the year 2022-23.

During the period of his internship he has exhibited punctuality and diligence. We wish his every success in life.

For Davanam Jewellers Pvt Ltd



Authorized Signatory

  
PRINCIPAL

The National College



## PROJECT COMPLETION LETTER

DATE: 8 JUNE 23

### TO WHOMSOEVER IT MAY CONCERN

This is to certify that Mr. KUSHAAL SIDDHA T bearing Reg. No. 20NCJC866 of VI Semester B. Com student, The National College, Autonomous, Jayanagar, Bangalore has successfully completed the project work for the period of 06 weeks on 24 APRIL 2023 to 8 JUNE 2023 under the guidance of MANAGER at our organisation towards the fulfilment of award of "Bachelor of Commerce" during the year 2022-23.

The title of his project work was "A PROJECT ON STRESS MANAGEMENT AND CONFLICT RESOLUTIONS".

During the period of his project with us he has exhibited punctuality and diligence. We wish him every success in life.

Thanking you.

For, WONFIN SOLUTIONS.



Authorised signatory

  
PRINCIPAL  
The National College  
Jayanagar, Bangalore-70



**SRSV AGRO COMPANY**

# 8/69, 'Prabhat Complex'  
Kempegowda Road  
Bengaluru - 560 009

## **INTERNSHIP COMPLETION CERTIFICATE**

This is to certify that Ms. Kavya N, Register No.20NCJC865, B.com Final Year student of The National College, Autonomous, Jayanagar, Bangalore has Successfully Completed Internship of 10 days Under the Guidance of  
At Tanishq Caratlane Jayanagar, Towards the fulfillment of the award of 'Bachelor of Commerce' during the year of 2022 - 23.

During the period of her internship she exhibited punctuality and diligence. We wish her every success in life.

Date :02/11/2022

Place:Bangalore

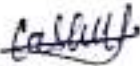

Hr-Executive

Tanishq Jayanagar



PRINCIPAL  
The National College  
Jayanagar, Bangalore-70



Show Room : No. 83/2, 9th Main Road, 4th Block, Jayanagar, BENGALURU - 560 011  
Mob : 7338273383



## PROJECT COMPLETION LETTER

DATE: 23/05/23

### TO WHOMSOEVER IT MAY CONCERN

This is to certify that Ms. KAVYA N bearing Reg. No. 20NCICR65 of VI Semester B.Com student, The National College, Autonomous, Jayanagar, Bangalore has successfully completed the project work for the period of 06 weeks on 22 MAY 2023 under the guidance of SMITHA Human resources TATA AIG at our organisation towards the fulfilment of award of "Bachelor of Commerce" during the year 2022-23.

The title of her project work was "A PROJECT REPORT ON HEALTH INSURANCE AT TATA AIG".

During the period of her project with us she has exhibited punctuality and diligence. We wish her every success in life.

Thanking you.

For, TATA AIG

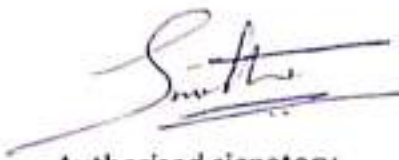

Authorised signatory

  
PRINCIPAL  
The National College  
Jayanagar, Bangalore-70





# Swemed Biomedicals Pvt. Ltd.

29/1 first floor, Chunchanaghatta Cross, Yelachenahalli, Bengaluru 560062

## INTERNSHIP COMPLETION CERTIFICATE

This is to certify that S.JAYANTH, Reg No. 20NCJC864, B.Com Final Year student of The National College, Autonomous, Jayanagar, Bangalore has successfully completed internship of six weeks under the guidance of - K.KUMAR SHARMA at this organization, towards the fulfillment of the award of 'Bachelor of Commerce' during the year 2022-23.

During the period of his internship he has exhibited punctuality and diligence. We wish his every success in life.

Yours Sincerely

For Swemed Biomedicals Pvt. Ltd.

For SWEMED BIOMEDICALS PVT. LTD

Kumar  
Authorized signatory  
K KUMAR SHARMA  
HR MANAGER

D. Sudh  
PRINCIPAL  
The National College  
Jayanagar, Bangalore-70



## TO WHOMSOEVER IT MAY CONCERN

This is to certify that Mr. S.JAYANTH bearing Reg. No 20NCJC864 of VI Semester B.Com student, The National College, Autonomous, Jayanagar, Bangalore has successfully completed the project work for the period of 06 weeks 2/5/2023 to 30/5/2023 under the guidance of **JAGGA REDDY – MARKETING HEAD** at our organisation towards the fulfilment of award of “Bachelor of Commerce” during the year 2021-22.

The title of his project work was Effect of sales forecast on marketing decision making

During the period of his project with us he has exhibited punctuality and diligence. We wish him every success in life.

Thanking you.



Authorised signatory with company seal

  
PRINCIPAL  
The National College  
Jayanagar, Bangalore-70.







# Toyotetsu India Private Limited

TTIA/HRD/Sid-PJT./2022-23

Date: 27.09.2022

Dr. N K Satya Pal Sharma  
Head – Department of Commerce,  
The National College,  
Jayanagar, Bangalore-560 070

Dear Sir,

**Subject: Permission to your student to carry out Internship in our organization.**  
**Reference: Letter from college dated 20.09.2022**

With respect to the subject matter & request letter dt. 20.09.2022 seeking permission to carry out Internship at our organization has been examined and we are pleased to inform you that the permission has been accorded to your student **Ms. Gouthami M (Reg No: 20NCJC863)** to carry out Internship program for the period of 6 weeks starting from 27<sup>th</sup> Sep 2022 on daily basis.

During the training period, student must report to **Finance & Accounts Department** without fail on daily basis. At the end of the internship program, student must submit a detailed report on her study to the management. Student, while collecting data for her internship program such as balance sheet / financials, photos, write-ups etc., she must obtain necessary permission from the concerned authority. Data collected from our organization must be used for academic purposes only.

Company will be provided with subsidized canteen facility to the trainee. We at TTIA regard Safety attitude as important discipline and every individual must follow all Safety norms without fail at all times.

Student trainee have to abide by all the Rules & Regulations of the company during the training period, also must and should carry college ID card every day. Failing which this permission will be curtailed without any communication.

Thanking you.

For Toyotetsu India Pvt. Ltd.

  
Umashankar K  
GM – HR, IR & Admin.

  
PRINCIPAL  
The National College  
Jayanagar, Bangalore-70.



Toyota Techno Park, Plot No. 20, Bldg. No 2, Bidadi Industrial Area, Bidadi,  
Ramanagar District - 562 109, Karnataka, India.  
Ph. : +91-80-27287158 / 159 / 174 / 175 Fax : +91-80-27287153  
CIN : U34300KA1998PTC024464



**A-RAVI RAG INDUSTRIES**

**TO WHOMSOEVER IT MAY CONCERN**

This is to certify that MS.GAUTHAMI M bearing Reg. No. 20NCJC863 of VI Semester B.Com student, The National College, Autonomous, Jayanagar, Bangalore has successfully completed the project work for the period of 04 weeks under the guidance of Mr. THULASI KUMAR at our organization towards the fulfilment of award of "Bachelor of Commerce" during the year 2022-23.

The title of his project work was

During the period of his project with us he has exhibited punctuality and diligence. We wish Her every success in life.

Thanking you.

**A-Ravi Rag industries**

*[Handwritten Signature]*

PRINCIPAL

The National College  
Jayanagar, Bangalore-70.



*[Handwritten Signature]*



Reg - 862

**Fortis Hospitals Limited**  
154/9, Bannerghatta Road,  
Opp. IIM-B, Bangalore - 560 076  
Tel. : + 91-80-6621 4444, 2254 4444  
Fax : + 91-80-6621 4242  
care.bng@fortishealthcare.com  
CIN No. U93000DL2009PLC222166

21<sup>st</sup> November 2022

**TO WHOMSOEVER IT MAY CONCERN**

This is to certify that **Ms. Divya N**, B.Com Student of The National College has successfully completed her **"Internship in Finance Department"** at Fortis Hospital Ltd, Bangalore from 07<sup>th</sup> October 2022 to 21<sup>st</sup> November 2022.

We wish Ms. Divya N all success in her future endeavors.

For Fortis Hospital Limited

Sharath H  
Deputy Manager- HR



PRINCIPAL  
The National College  
Jayanagar, Bangalore-70



24\*7  
**EMERGENCY HELP LINE** **96860 96860**





TO WHOMSOEVER IT MAY CONCERN

This is to certify that Ms. Divya.N, bearing Reg. No. No.20ncjc862 of VI Semester B.Com student, The National College, Autonomous, Jayanagar, Bangalore has successfully completed the project work for the period of 06 weeks (02-5-2023 to 30-05-2023) under the guidance of Mr.R.G.M.VASANTH, Store-Manager, at our organisation towards the fulfilment of award of "Bachelor of Commerce" during the year 2022-23.

The title of her project work was "Competitive advantage of business success".

During the period of his/her project with us she has exhibited punctuality and diligence. We wish her every success in life.

Thanking you.

For Burger king

Authorised signatory  
BURGER KING INDIA LIMITED  
Unit No 1001B & T007,  
Royal Meenakshi Mall, 3rd Floor,  
Opp. Meenakshi Temple Hulimavu,  
Banneranatta Road, Bangalore - 56007

*Rathin*

*D. Sush*  
PRINCIPAL  
The National College  
Jayanagar, Bangalore-70



## INTERNSHIP COMPLETION CERTIFICATE

This is to certify that Mr. DHEERAJ CK, Reg No. 20NCJCS61, B.Com Final Year student of The National College, Autonomous, Jayanagar, Bangalore has successfully completed internship of 11 days under the guidance of Mr Ashok Savanth (Store Manager) at this organization (*Tanishq Bannerghatta Road*), towards the fulfillment of the award of 'Bachelor of Commerce' during the year 2022-23.

During the period of his/her internship he/she has exhibited punctuality and diligence. We wish his/her every success in life.

  
(Authorized signature with seal)



Date:

Place:

  
PRINCIPAL  
The National College  
Jayanagar, Bangalore-70





PROJECT COMPLETION LETTER

Date:18/05/2023

TO WHOMSOEVER IT MAY CONCERN

This is to certify that Mr. Dheeraj Ck bearing Reg. No. 20NCIC861 of VI Semester B.Com student, The National College, Autonomous, Jayanagar, Bangalore has successfully completed the project work for the period of 04 weeks 18.04.2023 to 18.05.2023 under the senior guidance at our organisation towards the fulfilment of award of "Bachelor of Commerce" during the year 2022-23.

The title of his project work was A Study on the impact of impact sale's promotion Of 3M

The project completion certificate will be issued to the student after submission of

The project report to organisation.

Thanking you

3M



3M VHB Tapes Technical Support

No.41, HMT Factory Main Road,

next to HMT School

*P. S. S.*  
PRINCIPAL  
The National College  
Jayanagar, Bangalore-70





TIN : 29440208029  
GSTIN : 29ALIPK7776Q12W



Mob: 9739710814

# ARUNACHALAM TRADERS

Dealers in : Wholesale & Retail Tea Powder, Suppliers of Assam, Darjiling, Nilgiri Tea & Spices  
# 6, Old Tharagupet Cross, G.S. Market, 1st Floor, Bangalore-560 053.

Date.....

Ref:

## INTERNSHIP COMPLETION CERTIFICATE

This is to certify that DHANU KUMAR. K Reg No.20NCJC860 B.Com Final Year student of The National College, Autonomous, Jayanagar, Bangalore has successfully completed internship of six weeks under the guidance of -PREM KUMAR at ARUNACHALAM TRADERS organisation, towards the fulfilment of the award of 'Bachelor of Commerce' during the year 2022-23.

During the period of his internship he has exhibited punctuality and diligence. We wish him every success in life.

For ARUNACHALAM TRADERS  
V.S. Kumar  
Proprietor

(Authorised signature with seal)

Date: 12-01-2023

Place: BANGALORE

  
PRINCIPAL  
The National College  
Jayanagar, Bangalore-70.



GSTIN : 29AEXPJ4577Q2Z3

Mob : +91 9036724426

# JAISHREE ENTERPRISES

# 07, Ground Floor, 1st Main, 2nd Cross, Sir M. Vishweswaraiah Layout, Opp. Raghavendra Mutt  
Devarachikkanahalli Main Road, Bengaluru -560 076. E-mail : jaya\_simha24@hotmail.com

Date:23-05-2023

## PROJECT COMPLETION LETTER

### TO WHOMSOEVER IT MAY CONCERN

This is to certify that Mr. DHANU KUMAR bearing Reg.No. 20NCJC860 of VI Semester B.Com student, The National College, Autonomous, Jayanagar, Bangalore has successfully completed the project work for the period of 06 weeks 11-04-2023 to 22-05-2023 under the guidance of M.Satish Kumar (Manager) at our organisation towards the fulfilment of the award of "Bachelor of Commerce" during the year 2021-22.

The title of his project work was "A study on financial planning for salaried employees."

During the period of his project with us he has exhibited punctuality and diligence. We wish her every success in life.

Thanking you.

Form,  
Jaishree garments



Authorised signatory

**JAISHREE ENTERPRISES**  
No.07, Ground Floor, 1st Main, 2nd Cross,  
Sir M Vishveshwaraiah Layout,  
Devarachikkanahalli Main Road,  
Opp. Raghavendra Mutt, Bangalore-560076.

  
PRINCIPAL  
The National College  
Jayanagar, Bangalore-70.



## CERTIFICATE BY THE GUIDE

This is to certify that **MR.DARSHAN N** bearing Reg. No. **20NCJC859** of the National college, Autonomous, Jayanagar has successfully completed the project work title "**A STUDY ON CONSUMER SATISFACTION.**" in partial fulfillment of requirement for the completion of Bachelor of Commerce program as prescribed by the our institution.

This project report is the record of authentic work carried out by him during the VI Semester of the B.Com Program.

He has work under my guidance. This report has not been submitted to any other university or institution for the award of any degree/diploma/certificate.

**Prof. Arun Kumar G S**  
**Department of Commerce**

Place:

Date:

  
PRINCIPAL  
The National College  
Jayanagar, Bangalore-70.





## CERTIFICATE BY THE GUIDE

This is to certify that **MR.DARSHAN N** bearing Reg. No. **20NCJC859** of the National college, Autonomous, Jayanagar has successfully completed the project work title "**A STUDY ON CONSUMER SATISFACTION.**" in partial fulfillment of requirement for the completion of Bachelor of Commerce program as prescribed by the our institution.

This project report is the record of authentic work carried out by him during the VI Semester of the B.Com Program.

He has work under my guidance. This report has not been submitted to any other university or institution for the award of any degree/diploma/certificate.

**Prof. Arun Kumar G S**  
**Department of Commerce**

Place:

Date:

  
PRINCIPAL  
The National College  
Jayanagar, Bangalore-70.



## INTERNSHIP COMPLETION CERTIFICATE

This is to certify that Mr.DARSHAN M, Reg No.20NCJC858, B.Com Final Year student of The National College, Autonomous, Jayanagar, Bangalore has successfully completed internship of 12 days under the guidance of Mr Ashok Savanth (Store Manager)at this organization (*Tanishq Bannerghatta Road*), towards the fulfillment of the award of '*Bachelor of Commerce*' during the year 2022-23.

During the period of his/her internship he/she has exhibited punctuality and diligence. We wish his/her every success in life.

(Authorized signature with seal)

Date:

Place:

  
PRINCIPAL  
The National College  
Jayanagar, Bangalore-70





This is to certify that **Mr. DARSHAN. M** bearing Register No.20NCJC858, VI semester B. Com, **The National College, Autonomous**, Jayanagar, Bangalore has successfully completed a Project of four weeks (from 10/04/2022 to 06/05/2022) under the guidance of (**Mr. AMITH, STORE MANAGER**) at this outlet, towards the fulfilment of award of "Bachelor of Commerce" during the year 2022 – 2023.

The title of his project work was **CUSTOMER PREFERENCE TOWARDS BRANDED & NON BRANDED JEWELLERY.**

During the period of his Project he has exhibited punctuality and diligence. We wish him every success in life.

Date :10/05/2023

Place: Bangalore

  
PRINCIPAL  
The National College  
Jayanagar, Bangalore-70.

Authorized Signature



#1493, ground floor, near 9<sup>th</sup> block bus stop, 22<sup>nd</sup> main road, 40<sup>th</sup> cross Rd, 4<sup>th</sup> T block east, Jayanagar , Bengaluru, Karnataka 560041, Phone no: 7996998896,  
Email- [vardhmanjewellery@gmail.com](mailto:vardhmanjewellery@gmail.com) , website: [vardhmanjewellers.com](http://vardhmanjewellers.com)





**Karnataka Turned Components Pvt. Ltd.**

Precision Engineering Components

## INTERNSHIP COMPLETION CERTIFICATE

This is to certify that Mr. Chetan. G A Reg. No. 20NCJC857, B.Com final year student of The National College, Autonomous, Jayanagar, Bangalore has successfully completed internship of six weeks under the guidance of Mr. Masilamani. N at this organization, towards the fulfillment of the award of "Bachelor of Commerce" during the year 2022-23.

During the period of His internship has exhibited punctuality and diligence. We wish his every success in life.

Sincerely,

Karnataka Turned Components Pvt Ltd.,

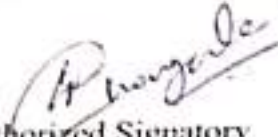
  
Authorized Signatory  
Asst. Manager- Human Resources



Date: 15/11/2022

Place: Bangalore

  
PRINCIPAL  
The National College  
Jayanagar, Bangalore-70.





# B N Speciality Hospital

Care With Compassion..... Adding Value to Life

#2, "YASHASH COMPLEX", Kalkondrahalli,  
Kasavanahalli Road, Off Sarjapur Main Road,  
Carmelaram Post, Bengaluru - 560 035.

Ph: 080 5000 6689  
+91 9620195989

Email: bnspecialityhospital@gmail.com

## PROJECT COMPLETION LETTER

### TO WHOMSOEVER IT MAY CONCERN

This is to certify that **Mr. CHETHAN G.A** bearing **Reg.No.20NCJC857** Of VI Semester B.Com student, The National College, Autonomous, Jayanagar, Bangalore has successfully completed the project work for the period of 04 weeks (01-04-2023 To 29-04-2023) under the guidance of A.Rajkumar Designation of External guide Managing Director at our organization towards. The fulfillment of award of "Bachelor of Commerce" during the year 2022-23.

The title of his project work was **THE PROJECT ON JOB SATISFACTION OF EMPLOYEES ON B N SPACIALITY HOSPITAL**

During the period of his project with us he has exhibited punctuality and diligence. We wish him every success in life.

Thanking you.

For, BN SPECIALTY HOSPITAL

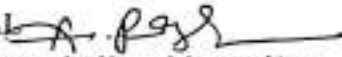
  
**B.N. Speciality Hospital**  
Kasavanahalli Road, Off Sarjapura  
Main Road, Bengaluru-560 035  
Ph.: 8050006689/7411001250

Authorized signatory with company seal

  
PRINCIPAL

The National College

Jayanagar, Bangalore-70



**SPECIALITIES** : General Surgery • Internal Medicine & Diabetology • Cardiology Non-Interventional • Pediatrics  
Obstetrics and Gynecology • Orthopaedics • ENT • Dermatology • Urology • In Patient • Day Care

**FACILITIES** : Specialist Consultation • Lab Facilities • Preventive Health Checkups • Physiotherapy  
Home Care and Doorstep Sample Collection • X-Ray • ECG • Pharmacy 24/7

**Please bring your OLD MEDICAL REPORTS & X-RAY with you.**  
**FOR APPOINTMENT CALL : 080-5000 6689, +91 9620195989**



## PROJECT COMPLETION LETTER

### TO WHOMSOEVER IT MAY CONCERN

This is to certify that Mr./Ms. Ashish V bearing Reg. No. 20NCJC855 of VI Semester B.Com student, The National College, Autonomous, Jayanagar, Bangalore has successfully completed the project work for the period of 06 weeks (01/04/2023 to 12/05/2023) under the guidance of (Sharu & Store Manager) at our organisation towards the fulfilment of award of "Bachelor of Commerce" during the year 2022-23.

The title of his/her project work was : Consumer perceptions of packing on sales of groceries products at Blinkit.

During the period of his project with us he has exhibited punctuality and diligence. We wish him every success in life.

Thanking you.

For, (BLINKIT)



Authorised signatory with company seal

*(Handwritten Signature)*  
PRINCIPAL  
The National College  
Jayanagar, Bangalore-70.







## PROJECT COMPLETION LETTER

### TO WHOMSOEVER IT MAY CONCERN

This is to certify that Mr./Ms. Ashish V bearing Reg. No. 20NCJC855 of VI Semester B.Com student, The National College, Autonomous, Jayanagar, Bangalore has successfully completed the project work for the period of 06 weeks (01/04/2023 to 12/05/2023) under the guidance of (Sharu & Store Manager) at our organisation towards the fulfilment of award of "Bachelor of Commerce" during the year 2022-23.

The title of his/her project work was : Consumer perceptions of packing on sales of groceries products at Blinkit.

During the period of his project with us he has exhibited punctuality and diligence. We wish him every success in life.

Thanking you.

For, (BLINKIT)



Authorised signatory with company seal

PRINCIPAL  
The National College  
Jayanagar, Bangalore-70.



## INTERNSHIP COMPLETION CERTIFICATE

This is to certify that Mr.ABHISHEK B, Reg No.20NCJC854, B.Com Final Year student of The National College, Autonomous, Jayanagar, Bangalore has successfully completed Internship of 10 days under the guidance of Mr Ashok Savanth (Store Manager)at this organization (*Tanishq Bannerghatta Road*), towards the fulfillment of the award of '*Bachelor of Commerce*' during the year 2022-23.

During the period of his/her Internship he/she has exhibited punctuality and diligence. We wish his/her every success in life.

(Authorized signature with seal)

Date:

Place:

  
PRINCIPAL  
The National College  
Jayanagar, Bangalore-70





# Briskon

TRANSFORM WITH AGILITY

NO.38/5, Berlle Street,  
Langford Town, Hosur Road,  
Bengaluru - 560078

Ref:

Date: 11/06/2023

**PROJECT COMPLETION LETTER**  
**TO WHOMSOEVER IT MAY CONCERN**

This is to certify that Mr. Abhishek.B bearing Reg. No. 20NCJC854 of VI Semester B.Com student, The National College, Autonomous, Jayanagar, Bangalore has successfully completed the project work for the period of 04 weeks 10/05/2023 to 10/06/2023 under the guidance of Mr. Naval Shetty (HR Manager) at our organization towards the fulfillment of award of "Bachelor of Commerce" during the year 2021-22.

The title of his project work was: **A Study on Effectiveness of performance appraisal of an employee in Briskon Technologies Pvt Ltd.**

During the period of his project with us he has exhibited punctuality and diligence. We wish him every success in life.

Thanking you.

**Briskon Technologies Pvt Ltd.**

For Briskon Technologies Pvt. Ltd.

  
Authorised Signatory

Authorised signatory

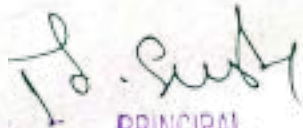
  
PRINCIPAL  
The National College  
Jayanagar, Bangalore-70.





ಮೊಬೈಲ್ : 95358 39393



## ಪದ್ಮಶಾಲ ವಿದ್ಯಾಸಂಸ್ಥೆ (ಲ)

ಪದ್ಮಶ್ರೀ ನರ್ಸರಿ ಮತ್ತು ಹಿರಿಯ ಪ್ರಾಥಮಿಕ ಶಾಲೆ  
(ಕರ್ನಾಟಕ ಸರ್ಕಾರದ ಮಾನ್ಯತೆ ಪಡೆದಿದೆ)

3ನೇ ಕ್ರಾಸ್, ಅಶ್ವತ್ಥಕಟ್ಟೆ ಮುಖ್ಯರಸ್ತೆ, ಕಸ್ತೂರಿಬಾನಗರ, ಬೆಂಗಳೂರು - 560 026.

ಸಂಖ್ಯೆ :

ದಿನಾಂಕ : 28/09/2022

To  
Dr. N K Satya Pal Sharma  
HOD- Department of Commerce  
The National College Autonomous  
Jayanagar, Bangalore- 70

Dear Sir,

Subject: Internship Acceptance Letter –ABHISHEK.M Reg no (20NCJC853)

This is to certify that ABHISHEK.M has joined in our institution on 28/09/2022 and he will be working as internship trainee (Accounts department) in our Institution for the period of 45 days.

Thanking You

Shashi Kalarathky .M

ಶಾಶಿ ಕಲರಾತ್ಯ .ಎಂ  
Padmasree Higher Primary School  
3rd Cross, Ashwathkatte Road  
Kasturba Nagar, Bengaluru - 560026

Padmasree Higher Primary School  
3rd Cross, Ashwathkatte Road  
Kasturba Nagar, Bengaluru - 560026

  
PRINCIPAL  
The National College  
Jayanagar, Bangalore-70





ಬೆಂಗಳೂರು ಮಹಾನಗರ ಸಾರಿಗೆ ಸಂಸ್ಥೆ :: ಕೇಂದ್ರ ಕಛೇರಿ

ದಿನಾಂಕ: 18 / 08 / 2023

ಸಂಖ್ಯೆ/ಕೇ/ / 2023-24

ಮೀಸಲಾತಿ ಮತ್ತು ಕಲ್ಯಾಣಾಧಿಕಾರಿಗಳು (ಮಾಸಂಲ),  
 ಸಂಪನ್ಮೂಲ ಅಭಿವೃದ್ಧಿ ಇಲಾಖೆ,  
 ಬೆಂಗಳೂರು ಮಹಾನಗರ ಸಾರಿಗೆ ಸಂಸ್ಥೆ,  
 ಕೆ.ಆರ್. ಶಾಂತಿನಗರ,  
 ಬೆ - 560 027.

ಶಾಸ್ತ್ರೀ,

ವಿಷಯ:- ಬೆಂ.ಮ.ಸಾ.ಸಂಸ್ಥೆಯಲ್ಲಿ ಕೈಗೊಂಡ ಉದ್ದೇಶಕ್ಕಾಗಿ ವಿದ್ಯಾರ್ಥಿಗಳು ಪ್ರಾಜೆಕ್ಟ್ ವರ್ಕ್ ಮಾಡಿ ವರದಿ ಸಲ್ಲಿಸಿರುವ ಕುರಿತು.

\*\*\*\*\*

ಇದರಲ್ಲಿ ವಿಷಯಕ್ಕೆ ಸಂಬಂಧಿಸಿದಂತೆ, **ಅಭಿವೃದ್ಧಿ ವಿ** ರವರು ಕೈಗೊಂಡ  
 ಬೆಂ.ಮ.ಸಾ.ಸಂಸ್ಥೆಯ **ಪ್ರಾಜೆಕ್ಟ್** ಇಲಾಖೆಯಲ್ಲಿ "ORGANISATION STUDY ON  
 ವಿಷಯದಲ್ಲಿ ಪ್ರಾಜೆಕ್ಟ್ ವರ್ಕ್ ಮಾಡಿದ್ದು, ಈ ಬಗ್ಗೆ ವರದಿಯನ್ನು  
 ಸದರಿ ವರದಿಯನ್ನು ಪರಿಶೀಲಿಸಿದ್ದು, ಸಂಸ್ಥೆಗೆ ಸಂಬಂಧಪಟ್ಟ ಮಾಹಿತಿಯು ಸರಿಯಾಗಿರುತ್ತದೆ  
 ಪ್ರಾಜೆಕ್ಟ್ ವರ್ಕ್‌ನಲ್ಲಿ ಸಂಸ್ಥೆಯ ಕುರಿತು ಯಾವುದೇ ಪ್ರತಿಕೂಲವಾದ ಅಂಶಗಳು ಇರುವುದಿಲ್ಲ. ಸದರಿ  
 ಪ್ರಾಜೆಕ್ಟ್ ವರ್ಕ್ ಮಾಡಿರುವ ಕುರಿತು ಪ್ರಮಾಣ ಪತ್ರ ನೀಡಬಹುದಾಗಿದ್ದು, ಪ್ರಾಜೆಕ್ಟ್ ವರ್ಕ್‌ನ  
 ಸದರಿ ಪತ್ರದೊಂದಿಗೆ ಅಡಕಗೊಳಿಸಿ ತಮ್ಮ ಮುಂದಿನ ಕ್ರಮಕ್ಕಾಗಿ ಕಳುಹಿಸಲಾಗಿದೆ.

ತಮ್ಮ ವಿಶ್ವಾಸಿ,

*(Handwritten signature)*  
 18/08/23

*(Handwritten signature)*  
 PRINCIPAL  
 The National College  
 Javanagar, Bangalore-70.



# NITRO INDUSTRIES

Sheet Metal Fabrication: SS and MS.

DATE : 21/09/2022

TO  
DR. N K SATYA PAL SHARMA  
HOD- DEPARTMENT OF COMMERCE  
THE NATIONAL COLLEGE  
AUTONOMOUS  
JAYANAGAR, BANGALORE-70

DEAR SIR,

SUBJECT: INTERNSHIP ACCEPTANCE LETTER – YASHWANTH Y (20NCJC852)

THIS IS TO CERTIFY THAT MR. YASHWANTH Y REG. NO.20NCJC852 HAS JOINED IN OUR INDUSTRY ON 21/09/22 AND HE WILL BE WORKING AS INTERNSHIP TRAINEE IN OUR INDUSTRY FOR THE PERIOD OF 45 DAYS.

THANKING YOU



*D. Sush*  
PRINCIPAL  
The National College  
Jayanagar, Bangalore-70.







**FASHION  
FACTORY**  
BRANDS FOR LESS

## INTERNSHIP COMPLETION CERTIFICATE

This is to certify that J. VISHWAS Reg No. 20NCJC851. B. Com Final Year student of The National College, Autonomous, Jayanagar, Bangalore has successfully completed internship of six weeks under the guidance of – Ajith Kumar. at this organization, towards the fulfilment of the award of 'Bachelor of Commerce' during the year 2022-23.

During the period of his internship, he has exhibited punctuality and diligence. We wish his every success in life.

Yours Sincerely

For Reliance trends junior

K AJITH KUMAR

HR MANAGER

*Ajith Kumar*  
RELIANCE RETAIL LTD  
Survey No. 152/5, Doddathohur Village,  
Begur Hobli, Neeladri Rd, Bengaluru - 560100  
PRINCIPAL  
The National College,  
Jayanagar, Bangalore-70.





## PROJECT COMPLETION LETTER

### TO WHOMSOEVER IT MAY CONCERN

This is to certify that Mr.VISHWAS.J bearing Reg. No.20NCJC851 of VI Semester B.Com student, The National College, Autonomous, Jayanagar, Bangalore has successfully completed the project work for the period of 06 weeks (18/5/2023 TO 10/6/2023) under the guidance of (SULOCHANA.B AND HARSAN VARDAN) at our organisation towards the fulfilment of award of "Bachelor of Commerce" during the year 2021-22.

The title of his project work was Web designing on good wrapper.

During the period of his project with us he has exhibited punctuality and diligence. We wish him every success in life.

Thanking you.

For, YUNO PACKAGING PRIVATE LIMITED

Authorised signatory with company seal



*[Handwritten Signature]*

PRINCIPAL  
The National College  
Jayanagar, Bangalore-70





## INTERNSHIP COMPLETION CERTIFICATE.

This is to certify that mr.Vishal M Reg No.20NCJC850 B.Com Final Year student of The National College, Autonomous, Jayanagar, Bangalore has successfully completed internship of six weeks under the guidance of Praveen Kumar(Technical architect)at this organization, towards the fulfillment of the award of 'Bachelor of Commerce' during the year 2022-23.

During the period of his internship he has exhibited punctuality and diligence. We wish his every success in life.

*Handwritten initials/signature*



Date:  
Place:

Corporate Office: 11-82, Lakshmi Krupa, Tachana, Chinnai Street, Choolamedu, Chennai-600024, Tamilnadu

Web: [eyefocusip.com](http://eyefocusip.com) E-Mail: [info@eyefocusip.com](mailto:info@eyefocusip.com)

*Handwritten signature*  
PRINCIPAL  
The National College  
Jayanagar, Bangalore-70







HMT (International) Limited  
A Government of India Enterprise



## PROJECT COMPLETION LETTER

### TO WHOMSOEVER IT MAY CONCERN

This is to certify that Mrs. Vathsala bearing Reg No. 20NCJC849 of VI Semester B.Com student, The National College, Autonomous, Jayanagar, Bangalore has successfully completed the project work for the period of 06 weeks from 14.04.2023 to 01.06.2023 Under Ramesh, Departmental Head at our organisation towards the fulfilment of award of "Bachelor of Commerce" during the year 2022-2023.

The title of her project work was Effectiveness of team work and team building.

Her roles and responsibilities included that of Audit Associate. During the Project program with us she was found to be hardworking and efficient. We wish her lots of success in all her upcoming endeavours.

Thanking You.

Planotech

Authorised signatory with company seal



*J. S. Sush*  
PRINCIPAL  
The National College  
Jayanagar, Bangalore-70



## INTERNSHIP COMPLETION CERTIFICATE

This is to certify that Ms.VATHSALA BN, Reg No.20NCJC849, B.Com Final Year student of The National College, Autonomous, Jayanagar, Bangalore has successfully completed internship of 13 days under the guidance of Mr Ashok Savanth (Store Manager) at this organization (*Tanishq Bannerghatta Road*), towards the fulfillment of the award of 'Bachelor of Commerce' during the year 2022-23.

During the period of his/her internship he/she has exhibited punctuality and diligence. We wish his/her every success in life.

  
(Authorized signature with seal)



Date:

Place:

  
PRINCIPAL  
The National College  
Jayanagar, Bangalore-70.





## INTERNSHIP COMPLETION CERTIFICATE

This is to certify that UMA PAVANI.M Reg No.20NCJC848 B. Com Final Year student of The National College, Autonomous, Jayanagar, Bangalore has successfully completed internship of six weeks under the guidance of – SOUNDARYA P at this organization, towards the fulfilment of the award of 'Bachelor of Commerce' during the year 2022-23.

During the period of her internship, she has exhibited punctuality and diligence. We wish her every success in life.

  
DOMINGO'S PIZZA  
# 223, Ground Floor, 100th Road,  
Vajarahalli, Bengaluru-560 109.  
Ph - 9038955790

Date:

Place:

  
PRINCIPAL  
The National College  
Jayanagar, Bangalore-70.







**B. MALLAIAH & CO.,**  
CHARTERED ACCOUNTANTS

TO WHOMSOEVER IT MAY CONCERN

CERTIFICATE

This is to certify that Ms UMA PAVANI. M, Student of THE NATIONAL COLLEGE, AUTONOMOUS, Jayanagar bearing the register number 20NCJC848 has successfully completed 4 weeks (12.04.2023 to 11.05.2023) internship program at our Office. In internship program she handled Accounting, Tax Calculations and assisted by seniors in auditing process.

During the period of her internship program with us, she was found sincere, punctual and hardworking.

We wish her every success in life.

Place: Bangalore  
Date : 16.06.2023

For B. Mallaiah & Co.,  
Chartered Accountants  
FRN.083045



(B. Mallaiah)  
Partner  
M.No. 207769

*B. Mallaiah*  
16/06/2023

*[Signature]*  
PRINCIPAL  
The National College  
Jayanagar, Bangalore-70



## INTERNSHIP COMPLETION CERTIFICATE

This is to certify that Mr. UDAY SHANKAR KS, Reg No.20NCJC847, B.Com Final Year student of The National College, Autonomous, Jayanagar, Bangalore has successfully completed internship of 20 days under the guidance of Mr Ashok Savanth (Store Manager) at this organization (*Tanishq Bannerghatta Road*), towards the fulfillment of the award of '*Bachelor of Commerce*' during the year 2022-23.

During the period of his/her internship he/she has exhibited punctuality and diligence. We wish his/her every success in life.

  
(Authorized signature with seal)



Date:

Place:

  
PRINCIPAL  
The National College  
Jayanagar, Bangalore-70





## PROJECT COMPLETION LETTER

### TO WHOMSOEVER IT MAY CONCERN

This is to certify that **Mr. KS Udaya Shankar** bearing Reg No. **20NCJC847** of VI Semester B.Com student, The National College, Autonomous, Jayanagar, Bangalore has successfully completed the project work for the period of 06 weeks from 14.04.2023 to 01.06.2023 Under **Sudhakar**, Departmental Manager at our organisation towards the fulfilment of award of "Bachelor of Commerce" during the year 2022-2023.

The title of his project work was Corporate and Incorporate Event Manager

During the period of his project with us he has exhibited punctuality and diligence. We wish him every success in life.

Thanking You.

Planotech



Authorised signatory with company seal

*S. Sudhakar*  
PRINCIPAL  
The National College  
Jayanagar, Bangalore-70







ಕರ್ನಾಟಕ ಸಹಕಾರಿ ಹಾಲು ಉತ್ಪಾದಕರ ಮಹಾಸಂಘದ ನಿಯಮಿತ  
KARNATAKA CO-OPERATIVE MILK PRODUCER'S FEDERATION LIMITED



No.KMF/2040/Adm-1/2023

Date: 23.01.2023

**CERTIFICATE**

This is to certify that **Mr.Sumanth N (Reg.No.20NCJC845)** studying B.Com at The National College Autonomous, Jayanagar, Bengaluru, has successfully completed Internship on "Organization Study at Karnataka Milk Federation Ltd"during period from 29.09.2022 to 09.11.2022. This certificate is issued for the purpose of academics only. His conduct during this period is found to be good.

Your's faithfully,

for Karnataka Co-Operative Milk Federation Ltd.,

*Sumanth N. M*  
Joint Director (Admin)

ಸಂಘದ ನಿರ್ದೇಶಕರು (ಆಡಳಿತ)  
ಕರ್ನಾಟಕ ಸಹಕಾರಿ ಹಾಲು ಉತ್ಪಾದಕರ ಮಹಾಸಂಘದ ನಿಯಮಿತ  
ಬೆಂಗಳೂರು - 560 029

*S. S. S.*  
PRINCIPAL  
The National College  
Jayanagar, Bangalore-70

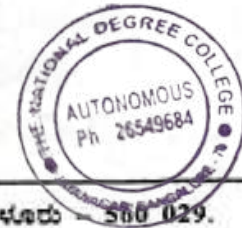

ಕೆ.ಎಂ.ಎಫ್ ಸಂಕೀರ್ಣ, ಅಂಚೆ ಚೀಲ ಸಂಖ್ಯೆ : 2915, ಡಾ|| ಎಂ.ಹೆಚ್. ಮರಿಗೌಡ ರಸ್ತೆ, ಬೆಂಗಳೂರು - 560 029.

Complex, P.B. No. 2915, Dr. M.H. Marigowda Road, Bengaluru - 560 029. Phone : 080-26096800, 25536625, Fax : 080-25536105.  
Email : ps.md@kmf.coop / admin@kmf.coop / finance@kmf.coop / marketing@kmf.coop / purchase@kmf.coop / mis@kmf.coop  
ahykmf@yahoo.com / step@kmf.coop / cli@kmf.coop / qc@kmf.coop / Website : www.kmfandini.coop

20NCJC845

**BLUE DART**

EXPRESS LIMITED  
Manipal road dwaraka nagar near,  
century indus apartment RR nagar,  
Bangalore - 560098.

[www.bluedart.com](http://www.bluedart.com)

Communications@bluedart.com

**TO WHOMSOEVER IT MAY CONCERN**

This is to certify that Mr. **SUMANTH N** bearing Reg. No.20NCJC845 of VI Semester B.com student, The National College, Autonomous, Jayanagar, Bangalore has successfully completed the project work for the period of 06 weeks **28<sup>th</sup> March 2023 to 12<sup>th</sup> May 2023** under the guidance of **Shilpa N, Manager** at our organisation towards the fulfilment of award of "Bachelor of Commerce" during the year 2022-23.

The title of his project work was "**A Project Study on Risk management with Special Reference to Blue Dart**".

During the period of his project with us he has exhibited punctuality and diligence. We wish him every success in life.

Thanking you,

For (BLUE DART EXPRESS LIMITED)



*Shilpa N*  
PRINCIPAL  
The National College  
Jayanagar, Bangalore-70



# SRSV AGRO COMPANY

# 8/69, 'Prabhat Complex'  
Kempegowda Road  
Bengaluru - 560 009

## INTERNSHIP COMPLETION CERTIFICATE

This is to certify that Mr. Shreyas, Register No. 20NCJC843, B.com Final Year student of The National College, Autonomous, Jayanagar, Bangalore has Successfully Completed Internship of 18 days Under the Guidance of Mr. Kishan At Mia Tanishq Jayanagar, Towards the fulfillment of the award of 'Bachelor of Commerce' during the year of 2022 - 23.

During the period of his internship he exhibited punctuality and diligence. We wish his every success in life.

Date : 02/11/2022

Place: Bangalore

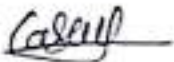

Hr-Executive

Tanishq Jayanagar

For SRSV AGRO COMPANY



PRINCIPAL  
The National College  
Jayanagar, Bangalore-70.



Show Room : No. 83/2, 9th Main Road, 4th Block, Jayanagar, BENGALURU - 560 011  
Mob : 7338273383



20NCJC843

#280/2, 4th Floor,  
Kothari Business Chambers,  
Kasturba Nagar,  
Mysore Road, Bangalore-560 026



## PROJECT COMPLETION LETTER

DATE: 30 MAY 23

### TO WHOMSOEVER IT MAY CONCERN

This is to certify that Mr. SHREYAS N M bearing Reg. No. 20NCJC843 of VI Semester B. Com student, The National College, Autonomous, Jayanagar, Bangalore has successfully completed the project work for the period of 06 weeks on 17 APRIL 2023 to 30 MAY 2023 under the guidance of MR. SHARAN AS MANAGER at our organisation towards the fulfilment of award of "Bachelor of Commerce" during the year 2022-23.

The title of his project work was "A STUDY ON IMPACT OF PERFORMANCE APPRAISAL ON STAFF PRODUCTIVITY".

During the period of his project with us he has exhibited punctuality and diligence. We wish him every success in life.

Thanking you.

For, RAJSONS PHARMA PVT LIMITED



*[Handwritten Signature]*  
PRINCIPAL  
The National College  
Jayanagar, Bangalore-70.



*[Handwritten Signature]*  
30/5/23  
Authorised signatory

## SRI MANJUNATHA TRACTORS & FARM EQUIPMENTS

Authorized dealer: **EICHER TRACTORS** (Sales, Service and Spares)  
54, No. 56/2, Madhavahalli, Navahalli Hobli, Old Delhi Main Road, Ankal, Bangalore-562106  
Mobile: 94832746068, 94832746069 e-mail: sriharitractors2@gmail.com



## INTERNSHIP COMPLETION CERTIFICATE

This is to certify that Shashank, Reg No. 20NCJC842, B.Com Final Year student of The National College, Autonomous, Jayanagar, Bangalore has successfully completed internship of six weeks under the guidance of – Harshith.S at this organization, towards the fulfillment of the award of 'Bachelor of Commerce' during the year 2022-23.

During the period of his internship he has exhibited punctuality and diligence. We wish his every success in life.

Thankyou  
Your regards



Harshith.S.  
Sales Manager

PRINCIPAL  
The National College  
Jayanagar, Bangalore-70





**Aghanta Retail Pvt. Ltd.**

Corporate Office: 237, 1<sup>st</sup> Floor, Pail Business Center, RMV Extension, DE C.V Ransan Road,  
Sadashivanagar Bengaluru 80  
www.alpinevivaapl.com

## PROJECT COMPLETION LETTER

### TO WHOMSOEVER IT MAY CONCERN

This is to certify that Mr. Shashank bearing Reg. No. 20NCJC842 of VI Semester B.Com., student, The National College, Autonomous, Jayanagar, Bangalore has successfully completed the project work for the period of 06 weeks 10th April 2023 to 20<sup>th</sup> May 2023 under the guidance of Mr. Nagaraj G Finance Manager at our organization towards the fulfillment of award of "Bachelor of Commerce" during the year 2022-23.

The title of his project work was :- Profit management system .

During the period of his project with us he has exhibited punctuality and diligence. We wish him every success in life.

Thanking you.

For and on behalf of Aghanta Retail Pvt. Limited.

  
Mr. Nagaraj. G

Finance Manager.

Aghanta Retail Pvt. Ltd.  
Alpine Viva Owners Welfare  
Association (AVOWA)  
S.No. 139, Whitefield, Hoskote Road  
Sai Gardens, Seegehalli  
Krishnarajapura, Bangalore-560 067

  
PRINCIPAL

The National College  
Jayanagar, Bangalore-70.





# SRV RETAIL

Office : # 19, Platform Road  
Seshadripuram  
Bengaluru - 560 020  
Tel : 080-23566055

## INTERNSHIP COMPLETION CERTIFICATE

This is to certify that Mr. SANJAN MA, Reg No.20NCJC841, B.Com Final Year student of The National College, Autonomous, Jayanagar, Bangalore has successfully completed internship of 24 days under the guidance of Mr Ashok Savanth (Store Manager) at this organization (*Tanishq Bannerghatta Road*), towards the fulfillment of the award of '*Bachelor of Commerce*' during the year 2022-23.

During the period of his/her internship he/she has exhibited punctuality and diligence. We wish his/her every success in life.

  
(Authorized signature with seal)



Date:

Place:

  
PRINCIPAL  
The National College  
Jayanagar, Bangalore-70



**TO WHOMSOEVER IT MAY CONCERN**

This is to certify that Mr./Ms. SPANSA N. D bearing Reg. No. 20NC3C841 of VI Semester B.Com student, The National College, Autonomous, Jayanagar, Bangalore has successfully completed the project work for the period of 06 weeks (Mention the dates) under the guidance of (Name & Designation of External guide) at our organisation towards the fulfilment of award of "Bachelor of Commerce" during the year 2021-22.

The title of his/her project work was AMAZON STORE DIGITAL AUDIT

During the period of his/her project with us he/she has exhibited punctuality and diligence. We wish him/her every success in life.

Thanking you.

For, (Company Name)



Authorised signatory with company seal

  
PRINCIPAL  
The National College  
Jayanagar, Bangalore-70.





# Swemed Biomedicals Pvt. Ltd.

29/1 first floor, Chunchanaghatta Cross, Yelachenahalli, Bengaluru 560062

## ACCEPTANCE LETTER

DATE: 9/10/2022

To  
Dr. N K Satya Pal Sharma  
HOD- Department of Commerce  
The National College  
Autonomous  
Jayanagar, Bangalore- 70

Dear sir,

Subject: Internship Acceptance Letter - SANTHOSH.S. Reg No: 20NCJC840

This is to certify that Mr. SANTHOSH.S. Reg. No. 20NCJC840 has joined in our organization on 9/10/2022 and he will be working as internship trainee in our **SWEMED Biomedicals Pvt. Ltd.** for the period of 45 days.

Thanking You

With Regards

For SWEMED Biomedicals Pvt. Ltd.

For SWEMED BIOMEDICALS PVT. LTD

*Kumars*  
Authorized signatory

HR Manager

*D. Sush*  
PRINCIPAL  
The National College  
Jayanagar, Bangalore-70







# Mahalakshmi Chemical Pvt. Ltd.

## TO WHOMSOEVER IT MAY CONCERN

This is to certify that Mr. Santosh. S, bearing Reg.No. 20NCJC840 of VI Semester B.Com student, The National College, Autonomous, Jayanagar, Bangalore has successfully completed the project work for the period of 6 weeks, From 17/04/2023 to 20/05/2023 under the guidance of (RAGHU KUMAR) at our organisation towards the fulfilment of award of "Bachelor of Commerce" during the year 2022-23.

The title of his project work was improving productivity through effective time management system

During the period of his project with us he has exhibited punctuality and diligence. We wish his every success in life.

Thank you,

For,  
Mahalakshmi Chemical Pvt. Ltd.

  
**Mahalakshmi Chemicals**  
No.8, Krishnanagar, Kothanur  
Main Road, Bangalore - 76

  
PRINCIPAL  
The National College  
Jayanagar, Bangalore-70.



**KMF**

ಕರ್ನಾಟಕ ಸಹಕಾರಿ ಹಾಲು ಉತ್ಪಾದಕರ ಮಹಾಮಂಡಳ ನಿಯಮಿತ  
KARNATAKA CO-OPERATIVE MILK PRODUCER'S FEDERATION LIMITED



No.KMF/2040/Adm-1/2023

Date: 23.01.2023

**CERTIFICATE**

This is to certify that Mr.Sai Manoj (Reg.No.20NCJC839) studying B.Com at The National College Autonomous, Jayanagar, Bengaluru, has successfully completed Internship on "Organization Study at Karnataka Milk Federation Ltd" during period from 29.09.2022 to 09.11.2022. This certificate is issued for the purpose of academics only. His conduct during this period is found to be good.

Your's faithfully,

for Karnataka Co-Operative Milk Federation Ltd.,

*Surekha N.M*  
Joint Director (Admin)

ಜಂಟಿ ನಿರ್ದೇಶಕರು (ಆಡಳಿತ)  
ಕರ್ನಾಟಕ ಹಾಲು ಮಹಾಮಂಡಳ ನಿಯಮಿತ  
ಬೆಂಗಳೂರು-560 029.

*S. Suresh*  
PRINCIPAL  
The National College  
Jayanagar, Bangalore-70



ಕೆ.ಎಂ.ಎಫ್ ಸಂಕೀರ್ಣ, ಅಂಚೆ ಬಿಲ್ಡ ಸಂಖ್ಯೆ : 2915, ಡಾ|| ಎಂ.ಹೆಚ್. ಮರಿಗೌಡ ರಸ್ತೆ, ಬೆಂಗಳೂರು - 560-029.

Complex, P.B. No. 2915, Dr. M.H. Marigowda Road, Bengaluru - 560 029. Phone : 080-26096800, 25536625, Fax : 080-25536105.  
Email : ps.md@kmf.coop / admin@kmf.coop / finance@kmf.coop / marketing@kmf.coop / purchase@kmf.coop / mis@kmf.coop  
ahykmf@yahoo.com / step@kmf.coop / cti@kmf.coop / qc@kmf.coop / Website : www.kmfandini.coop



PROJECT COMPLETION LETTER

TO WHOMSOEVER IT MAY CONCERN

This is to certify that Mr.SAI MANOJ bearing Reg. No.20NCJC839 of VI Semester B.Com student. The National College,Autonomous,Jayanagar,Bangalore. Has successfully completed the project work for the period of 04 weeks From 17-04-2023 To 17-05-2023 under the guidance of CA.REDDI KUMAR REDDY N, CHARTERED ACCOUNTANT, PROPRIETOR,@ NRK REDDY AND CO, CHARTERED ACCOUNTANTS towards the fulfillment of award of "Bachelor of Commerce" during the year 2022-23.

The title of his project is **Audit and Tax at NRK REDDY & CO**

During the period of his/her project with us he/she has exhibited punctuality and diligence. We wish him/her every success in life.

Thanking you.

For NRK REDDY AND CO,

For NRK REDDY AND CO,  
Chartered Accountants & CO,  
Chartered Accountants

CA Reddi Kumar Reddy N  
Proprietor  
M.No. 215714 FRN: 0115845  
Proprietor

Date: 20/05/2023

*[Signature]*  
PRINCIPAL  
The National College  
Jayanagar, Bangalore-70.







ST. JOHN'S NATIONAL ACADEMY OF HEALTH SCIENCES  
ST. JOHN'S MEDICAL COLLEGE HOSPITAL

Sarjapur Road,  
Bengaluru - 560 034, India.  
Tel : + 91 80 2206 5000  
+ 91 80 2553 0724  
Fax : + 91 80 2553 0070  
Email : [sjnchadmin.office@stjohns.in](mailto:sjnchadmin.office@stjohns.in)  
[www.stjohns.in](http://www.stjohns.in)



## INTERNSHIP COMPLETION CERTIFICATE

This is to certify that Mr. Robert Singh R Reg No. 20NCJ 838, B.Com Final Year student of The National College, Autonomous, Jayanagar, Bangalore has successfully completed internship of six weeks under the guidance of Mr. Batchu Nagaswaroop, CA, CMA Manager, Finance & Accounts at this organization, towards the fulfillment of the award of 'Bachelor of Commerce' during the year 2022-23.

During the period of his/her internship he/she has exhibited punctuality and diligence. We wish his/her every success in life.

*B. Nagaswaroop 18/11/22*  
(Authorized signature with seal)

MANAGER FINANCE & ACCOUNTS  
St. John's Medical College Hospital  
Sarjapur Road  
Bengaluru - 560 034

Date: 18/11/22  
Place: B'1077c

*B. Batchu*  
PRINCIPAL  
The National College  
Jayanagar, Bangalore-70





**Pragati Corporate Consultancy Pvt. Ltd**  
*We Rise By Lifting Others...*

## **PROJECT COMPLETION LETTER**

### **TO WHOMSOEVER IT MAY CONCERN**

This is to certify that Mr/Ms Robert Singh R bearing Reg. No. 20NCJC838 of VI Semester B.Com student, The National College, Autonomous, Jayanagar, Bangalore has successfully completed the project work for the period of 06 weeks (03-04-2023 To 29-04-2023) under the guidance of (Mr. J Jayaram, Manager in Pragati Corporate Consultancy Pvt Ltd) at our organisation towards the fulfilment of award of "Bachelor of Commerce" during the year 2021-22.

The title of his/her project work was - Talent Acquisition

During the period of his/her project with us he/she has exhibited punctuality and diligence. We wish him/her every success in life.

Thanking you.

For, (Pragati Corporate Consultancy Pvt Ltd)

For PRAGATI CORPORATE CONSULTANCY PVT. LTD.

MANAGING DIRECTOR

Authorised signatory with company seal

Get in touch with us:

[www.pragaticorporateconsultancy.com/](http://www.pragaticorporateconsultancy.com/)

[hr@pragaticorporateconsultancy.com](mailto:hr@pragaticorporateconsultancy.com)

PRAGATI CORPORATE CONSULTANCY PRIVATE LIMITED

Vakil Square, 3<sup>rd</sup> Floor, WJ92+W82 Bannerghatta Main Rd, KEB Colony, New Gurappana Palya, Jayanagara  
9<sup>th</sup> Block, BTM Layout Bengaluru, Karnataka 560029



# SRSV AGRO COMPANY

# 8/69, 'Prabhat Complex'  
Kempegowda Road  
Bengaluru - 560 009

## INTERNSHIP COMPLETION CERTIFICATE

This is to certify that Mr.Punith Gowda AJ, Register No.20NCJC236, B.com Final Year student of The National College, Autonomous, Jayanagar, Bangalore has Successfully Completed Internship of 17 days Under the Guidance of At Tanishq Caratlane Jayanagar, Towards the fulfillment of the award of 'Bachelor of Commerce' during the year of 2022 - 23.

During the period of his Internship he exhibited punctuality and diligence. We wish his every success in life.

Date :02/11/2022

Place:Bangalore

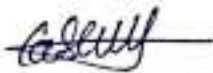

Hr-Executive

Tanishq Jayanagar

For SRSV AGRO COMPANY



PRINCIPAL  
The National College  
Jayanagar, Bangalore-70

Partner



Show Room : No. 83/2, 9th Main Road, 4th Block, Jayanagar, BENGALURU - 560 011  
Mob : 7338273383





**RATHNA PACKAGING INDIA PRIVATE LIMITED**  
*Solutions for Flexible Packaging Materials*

**TO WHOM SO EVER IT MAY CONCERN**

To,

The Head of Department - Commerce,  
The National College,  
Jayanagar, Bangalore – 560 070.

Dear Sir,

Sub: Acceptance of Inplant Training at our plant – Reg.

We agree to take Miss. G.Priyanka, Reg. No : 20NCJC835 as a In Plant trainee at our plant. Which is his part of Curriculum according to her communication the Training.

Yours truly,

For Rathna Packaging India Pvt Ltd,

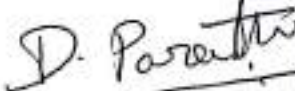
  
D. Paranthaman

Sr.Manager - HR

PHONE:9894767703.



Place : Hosur,

Date: 21-09-2022.

  
D. Sush

PRINCIPAL

Registered Office : No. 19, 15th Main, 15th Cross, Sector 4, HSR Layout, BANGALORE - 560 102, Karnataka, India | Tel: +91 80 25720005 | Ph: 26549684  
CIN No.: U21022KA2005PTC038098 | Email : rathnapackaging@yahoo.co.in | Web : www.rathnagroup.in  
Unit I : No. 55A, SIPCOT Industrial Complex, Phase 1, Mookandapalli Post, HOSUR - 635126, Krishnagiri Dist. Tel: +91 84344 40022 | Mob.: 8220009068  
Unit II : No. 852/2A, Aggondapalli Village, Achettyapalli Post - 635 110, DENKANIKOTTA Taluk, Krishnagiri Dist. | Mob.: 98942 56111  
Unit III : Sy. No. 66-2, Mugalapalli Village, Thommanapalli Panchayath, Bagalur to Berigai Road, Hosur - 635 105, Krishnagiri Dist.  
Unit IV : Plot No. 86, KIADB Industrial Area, 2nd Phase, 2nd Sector Bidadi - 562 109.





**RATHNA PACKAGING INDIA PRIVATE LIMITED**  
*Solutions for Flexible Packaging Materials*

**TO WHOMSOEVER IT MAY CONCERN**

This is to certify that Ms.G.Priyanka bearing Reg.No. 20NCJC835 of VI Semester B.Com student, The National College, Autonomous, Jayanagar, Bangalore has successfully completed the project work for the period of 6 weeks, From 17/04/2023 to 26/05/2023 under the guidance of (SR.MANAGER - HR D. PARANTHAMAN) at our organisation towards the fulfilment of award of "Bachelor of Commerce" during the year 2022-23.

The title of her project work was **Impact of Packaging on Consumer buying Behaviour**

During the period of her project with us she has exhibited punctuality and diligence. We wish her every success in life.

Thank you



For,

*D. Paranthaman*

Rathana Packaging India Pvt Ltd

*S. Sush*  
PRINCIPAL  
The National College  
Jayanagar, Bangalore-70.



Registered Office: No. 19, 15th Main, 15th Cross, Sector 4, HSR Layout, BANGALORE-580 102, Karnataka, India Tel: +91 80 25720905  
No: U21022KA2005PTC038098 | Email: rathnapackagingipl@yahoo.co.in | Web: [www.rathnagroup.in](http://www.rathnagroup.in)  
: No. 55A, SIPCOT Industrial Complex, Phase I, Mookandapalli Post, HOSUR-635126, Krishnagiri Dist. Tel: +91 04344 400221, Mob: 8220009068  
: No. 852/2A, Aggandapalli Village, Achettyapalli Post-635 110, DENKANIKOTTA Taluk, Krishnagiri Dist. Mob: 96542 56111  
: Sy. No. 66-2, Mugalapalli Village, Thommanapalli Panchayath, Bagalur to Berigal Road, Hosur - 635 105, Krishnagiri Dist.  
V: Plot No. 86, KIADB Industrial Area, 2nd Phase, 2nd Sector Bidadi-562 109.





**RATHNA PACKAGING INDIA PRIVATE LIMITED**  
*Solutions for Flexible Packaging Materials*

**TO WHOMSOEVER IT MAY CONCERN**

This is to certify that Ms.G.Priyanka bearing Reg.No. 20NCJC835 of VI Semester B.Com student, The National College, Autonomous, Jayanagar, Bangalore has successfully completed the project work for the period of 6 weeks, From 17/04/2023 to 26/05/2023 under the guidance of (SR.MANAGER - HR D. PARANTHAMAN) at our organisation towards the fulfilment of award of "Bachelor of Commerce" during the year 2022-23.

The title of her project work was **Impact of Packaging on Consumer buying Behaviour**

During the period of her project with us she has exhibited punctuality and diligence. We wish her every success in life.

Thank you



For,

*D. Paranthaman*

Rathana Packaging India Pvt Ltd

*S. Sush*  
PRINCIPAL  
The National College  
Jayanagar, Bangalore-70.



Registered Office: No. 19, 15th Main, 15th Cross, Sector 4, HSR Layout, BANGALORE-580 102, Karnataka, India Tel: +91 80 25720905  
No: U21022KA2005PTC038098 | Email: rathnapackagingipl@yahoo.co.in | Web: [www.rathnagroup.in](http://www.rathnagroup.in)  
: No. 55A, SIPCOT Industrial Complex, Phase I, Mookandapalli Post, HOSUR-635126, Krishnagiri Dist. Tel: +91 04344 400221, Mob.: 8220009068  
: No. 852/2A, Aggandapalli Village, Achettyapalli Post-635 110, DENKANIKOTTA Taluk, Krishnagiri Dist. Mob: 96542 56111  
: Sy. No. 66-2, Mugalapalli Village, Thommanapalli Panchayath, Bagalur to Berigal Road, Hosur - 635 105, Krishnagiri Dist.  
V: Plot No. 86, KIADB Industrial Area, 2nd Phase, 2nd Sector Bidadi-562 109.







LOANZEN FINANCE PVT LTD

CIN: U65999KA2017PTC100666 | www.loanzen.in

Office: No. 445/1 2<sup>nd</sup> Floor, 6<sup>th</sup> Cross Road, Jayanagar 7<sup>th</sup> Block, West of Kanakapura road  
Bangalore - 560070

Contact: +91 91080 47087, hello@loanzen.in

### Acceptance Letter

November 02, 2022

To,  
Dr. N K Satya Pal Sharma  
HOD – Department of Commerce  
The National College  
Autonomous  
Jayanagar, Bangalore – 70

**Subject: Internship acceptance Letter - Pramodh M / 20NCJC833**

Dear Sir,

This is to certify that Mr. Pramodh M, Reg No - 20NCJC833 has joined our organization on November 02, 2022 and will be working as internship trainee on our company for a period of 45 days.

Thanking You,

With Regards,

For Loanzen Finance Private. Ltd,

  
Authorized Signatory  

  
PRINCIPAL  
The National College  
Jayanagar, Bangalore-70





युनाइटेड इंडिया इन्शुरेन्स कंपनी लिमिटेड  
UNITED INDIA INSURANCE COMPANY LTD.  
At United India, it's always U before I

## PROJECT COMPLETION LETTER

DATE: 27 MAY 2023

### TO WHOMSOEVER IT MAY CONCERN

This is to certify that Mr. PRAMODH M bearing Reg. No. 20NCJC833 of VI Semester B.Com student, The National College, Autonomous, Jayanagar, Bangalore has successfully completed the project work for the period of 06 weeks on 17 APRIL 2023 TO 27 MAY 2023 under the guidance of MR PRAKASH S UNITED INDIA INSURANCE LIMITED at our organisation towards the fulfilment of award of "Bachelor of Commerce" during the year 2022-23.

The title of his project work was "A STUDY ON MOTOR INSURANCE AND CUSTOMER SATISFACTION TOWARDS MOTOR INSURANCE AT UNITED INDIA INSURANCE".

During the period of his project with us he has exhibited punctuality and diligence. We wish him every success in life.

Thanking you.

For, UNITED INDIA INSURANCE COMPANY LIMITED



Authorised signatory

  
PRINCIPAL  
The National College  
Jayanagar, Bangalore-70







युनाइटेड इंडिया इंश्योरेंस कंपनी लिमिटेड  
UNITED INDIA INSURANCE COMPANY LTD.  
At United India, it's always U before I

## PROJECT COMPLETION LETTER

DATE: 27 MAY 2023

### TO WHOMSOEVER IT MAY CONCERN

This is to certify that Mr. PRAMODH M bearing Reg. No. 20NCJC833 of VI Semester B.Com student, The National College, Autonomous, Jayanagar, Bangalore has successfully completed the project work for the period of 06 weeks on 17 APRIL 2023 TO 27 MAY 2023 under the guidance of MR PRAKASH S UNITED INDIA INSURANCE LIMITED at our organisation towards the fulfilment of award of "Bachelor of Commerce" during the year 2022-23.

The title of his project work was "A STUDY ON MOTOR INSURANCE AND CUSTOMER SATISFACTION TOWARDS MOTOR INSURANCE AT UNITED INDIA INSURANCE".

During the period of his project with us he has exhibited punctuality and diligence. We wish him every success in life.

Thanking you.

For, UNITED INDIA INSURANCE COMPANY LIMITED



Authorised signatory

  
PRINCIPAL  
The National College  
Jayanagar, Bangalore-70





Studio  
Unathi

Studio  
Unathi

ARCHITECTURE . INTERIORS . LANDSCAPE

## PROJECT COMPLETION LETTER

### TO WHOMSOEVER IT MAY CONCERN

This is to certify that PRAJWAL, V bearing Reg. No. 20NCJC832 of VI Semester B.Com student, The National College, Autonomous, Jayanagar, Bangalore has successfully completed the project work for the period of 04 weeks at STUDIO UNATHI under the guidance of Supreeth K. M at our organisation towards the fulfilment of the award of "Bachelor of Commerce" during the year 2023-24.

The title of his project work was "Customer Satisfaction"

During the period of her project with us she has exhibited punctuality and diligence. We wish her every success in life.

Thanking you,

*[Signature]*  
PRINCIPAL  
The National College  
Jayanagar, Bangalore-70

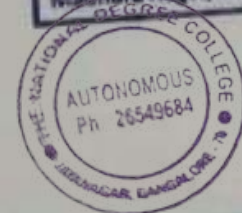

Studio  
Unathi

Studio  
Unathi

ARCHITECTURE . INTERIORS . LANDSCAPE

## PROJECT COMPLETION LETTER

### TO WHOMSOEVER IT MAY CONCERN

This is to certify that PRAJWAL, V bearing Reg. No. 20NCJC832 of VI Semester B.Com student, The National College, Autonomous, Jayanagar, Bangalore has successfully completed the project work for the period of 04 weeks at STUDIO UNATHI under the guidance of Supreeth K. M at our organisation towards the fulfilment of the award of "Bachelor of Commerce" during the year 2023-24.

The title of his project work was "Customer Satisfaction"

During the period of her project with us she has exhibited punctuality and diligence. We wish her every success in life.

Thanking you,



Authorised signatory with company seal

*[Handwritten Signature]*  
PRINCIPAL  
The National College  
Jayanagar, Bangalore-70

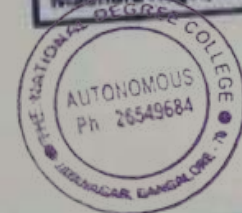

# Karnataka Bank Ltd.

F. No. 1304

Estd.: 1924



BRANCH .....

Date

Your Ref.

Our Ref.

This is to certify that Prajwal S Reg No.20NCJC831 B.Com Final Year student of The National College, Autonomous, Jayanagar, Bangalore has successfully completed internship of six weeks under the guidance of Mr.Shashikanth at this organization, towards the fulfillment of the award of 'Bachelor of Commerce' during the year 2022-23.

During the period of his internship he has exhibited punctuality and diligence. We wish his every success in life.

For KARNATAKA BANK LTD.

  
Branch Manager  
Naganathapura Branch

Date: 02/11/22

Place: Naganathapura Electronic City Post, Bangalore-560100

  
PRINCIPAL

The National College  
Jayanagar, Bangalore-70





**Karnataka Bank Ltd.**

Estd.: 1924

BRANCH ..... NAGANAATHAPURA  
BANGALORE - 560 106

Date

Your Ref.

Our Ref.

**TO WHOMSOEVER IT MAY CONCERN**

This is to certify that Mr. Prajwal S bearing Reg. No. 20NCJC831 of VI Semester B.Com student, The National College, Autonomous, Jayanagar, Bangalore has successfully completed the project work for the period of 04 weeks (3<sup>rd</sup> April 2023 to 29<sup>th</sup> April 2023) under the guidance of Shashikanth Manager at our organization towards the fulfilment of award of "Bachelor of Commerce" during the year 2022-23.

The title of his project work was Home Loan in Karnataka bank.

During the period of his project with us he has exhibited punctuality and diligence. We wish him every success in life.

Thanking you.

For, Karnataka Bank Limited  
For KARNATAKA BANK LTD.

*[Signature]*  
Branch Manager  
Naganaathapura Branch

*[Signature]*  
PRINCIPAL  
The National College  
Jayanagar, Bangalore-70



**Karnataka Bank Ltd.**

Estd.: 1924



BRANCH

NAGANATHAPURA  
BANGALORE - 560 040

Date

Your Ref.

Our Ref.

Date: 21/09/22



To  
Dr. N K Satya Pal Sharma  
HOD- Department of Commerce  
The National College  
Autonomous  
Jayanagar, Bangalore- 70

**Dear Sir,****Subject: Internship Acceptance Letter - Nithin M (20NCJC830)**

This is to certify that Mr. Nithin M Reg. No.20NCJC830 has joined in our organisation on 21/09/22 and he will be working as internship trainee in our Karnataka Bank for the period of 45 days.

**Thanking You****With Regards**

FOR KARNATAKA BANK LTD.

  
Branch Manager  
Naganathapura Branch  
PRINCIPAL  
The National College  
Jayanagar, Bangalore-70

830

**Karnataka Bank Ltd.**

F. No. 1304

Estd.: 1924

**KARNATAKA BANK LTD.**  
No. 75, Opp. Sobha Silicon Oasis Aptmt,  
Doddanangamangala Road, Vinayak Nagar,  
Naganathapura, Electronic City Post,  
Bangalore-560080.



BRANCH **NAGANATHAPURA,**  
**BANGALORE - 560 080**

Date

Your Ref.

Our Ref.

**TO WHOMSOEVER IT MAY CONCERN**

This is to certify that Mr. Nithin M bearing Reg. No. 20NCJC830 of VI Semester B.Com student, The National College, Autonomous, Jayanagar, Bangalore has successfully completed the project work for the period of 04 weeks (3<sup>rd</sup> April 2023 to 29<sup>th</sup> April 2023) under the guidance of (Mr. Shashikanth Manager) at our organization towards the fulfilment of award of "Bachelor of Commerce" during the year 2022-23.

The title of his project work was Recent trends in banking in Karnataka bank.

During the period of his project with us he has exhibited punctuality and diligence. We wish him every success in life.

Thanking you.

For, Karnataka Bank Limited  
For KARNATAKA BANK LTD.

  
Branch Manager  
Naganathapura Branch

  
PRINCIPAL  
The National College  
Jayanagar, Bangalore-70.





## INTERNSHIP COMPLETION CERTIFICATE

This is to certify that Mr. NAVEEN KUMAR R, Reg No.20NCJC829, B.Com Final Year student of The National College, Autonomous, Jayanagar, Bangalore has successfully completed internship of 18 days under the guidance of Mr Ashok Savanth (Store Manager) at this organization (*Tanishq Bannerghatta Road*), towards the fulfillment of the award of 'Bachelor of Commerce' during the year 2022-23.

During the period of his/her internship he/she has exhibited punctuality and diligence. We wish his/her every success in life.

*Ashok Savanth*



(Authorized signature with seal)

Date:

Place:

*D. Sush*  
PRINCIPAL  
The National College  
Jayanagar, Bangalore-70.



## PROJECT COMPLETION LETTER

### TO WHOMSOEVER IT MAY CONCERN

This is to certify that Mr./Ms. NAVEEN KUMAR R bearing Reg. No. 20NCJC829 of VI Semester B.Com student, The National College, Autonomous, Jayanagar, Bangalore has successfully completed the project work for the period of 06 weeks 22/05/2023 - 14/06/2023 under the guidance of ARUN A HR at our organisation towards the fulfilment of award of "Bachelor of Commerce" during the year 2022-23.

The title of his/her project work was A PROJECT REPORT ON CONSUMER BEHAVIOUR.

During the period of his/her project with us he/she has exhibited punctuality and diligence. We wish him/her every success in life.

Thanking you.

For, DECATHLON

  
Authorised signatory with company seal



  
PRINCIPAL  
The National College  
Jayanagar, Bangalore-70.





ಶಂಕರ ಸೂಪರ್ ಸ್ಪೆಷಾಲಿಟಿ ಆಸ್ಪತ್ರೆ  
**SHANKAR**  
 SUPER SPECIALITY HOSPITAL



## INTERNSHIP COMPLETION CERTIFICATE

This is to certify that Ms. Monisha, S Reg No.20NCJC828., B.ComFinal Year student of The National College, Autonomous, Jayanagar, Bangalore has successfully completed internship of six weeks under the guidance of Shankar Super Speciality Hospital at this organization, towards the fulfillment of the award of 'Bachelor of Commerce' during the year 2022-23.

During the period of her internship she has exhibited punctuality and diligence. We wish her every success in life.

(Authorized signature with seal)

**Managing Director**

Shankar Super Speciality Hospital

#68/5, Gangarapalya  
 Grama Main Road, Vejerahalli,

Kanakapura Main Road,  
 Bengaluru-560062.

Date: 07/12/2022

Place:

**PRINCIPAL**

The National College  
 Jayanagar, Bangalore-70



**TOLL FREE :**  
**1800 572 2544**





GINGER LAKE VIEW

PH: 9379791919 / 9035091919

EMAIL: GINGERLAKEVIEW@GMAIL.COM

GST: 29DMMPK2426PIZC

## PROJECT COMPLETION LETTER

### TO WHOMSOEVER IT MAY CONCERN

This is to certify that Mr./Ms.Monisha S bearing Reg. No.20NCJC828 of VI Semester B.Com student, The National College, Autonomous, Jayanagar, Bangalore has successfully completed the project work for the period of 06 weeks (Mention the dates) under the guidance of (Name & Designation of External guide) at our organisation towards the fulfilment of award of "Bachelor of Commerce" during the year 2022-23.

The title of his/her project work was Service Quality and customer Satisfaction.

During the period of his/her project with us he/she has exhibited punctuality and diligence. We wish him/her every success in life.

For Ginger Lake View Family Restaurant  
Thanking you.

  
Proprietor

For, (Ginger Lake View)

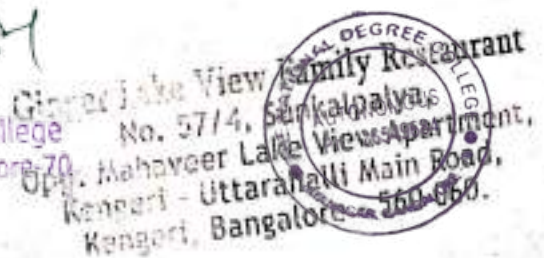

PRINCIPAL  
The National College  
Jayanagar, Bangalore-70

  
No. 5714, Sankalpa  
Kengeri - Uttarahalli Main Road,  
Kengeri, Bangalore-560060.

Authorised signatory with company seal



# ಕರ್ನಾಟಕ ವಿದ್ಯುತ್ ಪ್ರಸರಣ ನಿಗಮ ನಿಯಮಿತ

Registered Electrical Supply (ಸಿ.ಐ.ಎಸ್): 01040109ಕೆಎಚ್‌ಇಎಲ್‌ನಿಗಮ/25521

ಮಾನವ ಸಂಪನ್ಮೂಲ ಅಭಿವೃದ್ಧಿ ಕೇಂದ್ರ, ಕೆ.ಪಿ.ಪ್ರ.ಸಿ.ನಿ. ಹಬ್ಬಿ, ಹಬ್ಬಿ ಬೆಂಗಳೂರು-560 048

ಕಾರ್ಯಾಲಯ ಸಂಖ್ಯೆ: 080 20040600

ಇಂಟರ್‌ನೆಟ್: <https://kptel.karnataka.gov.in>

ಇ-ಮೇಲ್ ವಿಳಾಸ: [admin@kptel.karnataka.gov.in](mailto:admin@kptel.karnataka.gov.in)

ಕಂಪ್ಯೂಟರ್ ನಿಯಮಿತ/ಮಾ.ಸಂ.ಆ.ಕೇಂದ್ರ/275/35590/22-23

1327-77

ದಿನಾಂಕ: 1 OCT 2022

## ಅಧಿಕೃತ ಜ್ಞಾಪನಾ ಪತ್ರ

ವಿಷಯ: "General Finance" ವಿಷಯದ ಕುರಿತಂತೆ ಕೆ.ಪಿ.ಪ್ರ.ಸಿ.ನಿ. ಹಬ್ಬಿ ತರಬೇತಿಯನ್ನು ಮಾಡಲು ಅನುಮೋದನೆಯನ್ನು ನೀಡುವ ಬಗ್ಗೆ.

ಲಾಫಲಿಖಿ: ವಿ ನ್ಯಾಷನಲ್ ಕಾಲೇಜ್, ಬೆಂಗಳೂರು ರವರ ಪತ್ರ ದಿನಾಂಕ: 20.09.2022

\*\*\*\*\*

ವಿ ನ್ಯಾಷನಲ್ ಕಾಲೇಜ್, ಬೆಂಗಳೂರಿನಲ್ಲಿ ಬಿ.ಕಾಂ ಪದವಿಯಲ್ಲಿ ವ್ಯಾಸಂಗ ಮಾಡುತ್ತಿರುವ ಈ ಕೆಳಗಿನ ವಿದ್ಯಾರ್ಥಿಯು ಡಾ. ಕೆ. ರಾ. ಪ್ರದೀಪ್, ನಿಯಂತ್ರಣಾಧಿಕಾರಿ(ಲೆಕ್ಕಗಳು ಪಿಂಚಣಿ ಮತ್ತು ಮುಂಗಡ), ಕೆವಿಪ್ರಸಿ.ನಿ, ಕಾಲೇರಿ ಭವನ, ಬೆಂಗಳೂರು ರವರ ಮಾರ್ಗದರ್ಶನದಲ್ಲಿ "General Finance" ಎಂಬ ವಿಷಯದ ಕುರಿತಂತೆ, ದಿನಾಂಕ: 03.10.2022 ರಿಂದ 15.11.2022 ರವರೆಗೆ ತರಬೇತಿಯನ್ನು ಪಡೆಯಲು ಈ ಕೆಳಗಿನ ಪರಿಸ್ಥಿತಿಗಳಿಗೆ ಒಳಪಟ್ಟಂತೆ ಅನುಮೋದನೆಯನ್ನು ನೀಡಲಾಗಿದೆ.

- ಸವಲ ತರಬೇತಿಯು ಯಾವುದೇ ರೀತಿಯಲ್ಲೂ ಕೆವಿಪ್ರಸಿ.ನಿಯ ನಿಯಮಿತ ಕರ್ತವ್ಯಗಳನ್ನು ಅಡ್ಡಿಪಡಿಸಬಾರದು.
- ತರಬೇತಿ ಗಳಿಸಿದ ವಿದ್ಯಾರ್ಥಿಯು, ತರಬೇತಿಯು ಮುಗಿದ ನಂತರ ಅದರ ಮುಕ್ತಾಯ ಪರದಿಯನ್ನು ಕಾಲೇಜಿಗೆ ಅಂತಿಮ ಮಾರ್ಗದರ್ಶಕರ ಸಹಿ, ಕೆವಿಪ್ರಸಿ.ನಿಯ ಮಾರ್ಗದರ್ಶಕರ ಸಹಿ ಮತ್ತು ವಿದ್ಯಾರ್ಥಿಯ ಸಹಿಯನ್ನು ಒಳಗೊಂಡು ಈ ಕಛೇರಿಗೆ ಸಲ್ಲಿಸತಕ್ಕದ್ದು.
- ನಿಗದಿತ 'ಎ' ಸಮೂಹದಲ್ಲಿ ಕೆವಿಪ್ರಸಿ.ನಿಯ ಮಾರ್ಗದರ್ಶಕರು ಸಹಿ ಮಾಡಿದ ತರಬೇತಿಯ ಪರಿಶೀಲನಾ ಮತ್ತು ಮೂರ್ತಗೊಂಡ ದೃಢೀಕರಣ ಪತ್ರವನ್ನು ಈ ಕಛೇರಿಗೆ ಸಲ್ಲಿಸಿದ ನಂತರ, ಸಂಬಂಧಪಟ್ಟ ಕಾಲೇಜಿಗೆ ವಿದ್ಯಾರ್ಥಿಯ ತರಬೇತಿಯ ಮೂರ್ತಗೊಂಡ ಬಗ್ಗೆ, ಈ ಕಛೇರಿಯಿಂದ ಪ್ರಮಾಣ ಪತ್ರವನ್ನು ನೀಡಲಾಗುವುದು.

ಕ್ರಮ ಸಂ	ವಿದ್ಯಾರ್ಥಿನಿಯರ ಹೆಸರು	ಯು.ಎಸ್.ಎನ್.ನೋಂದಣಿ ಸಂಖ್ಯೆ
1	ವೊಹಮ್ಮದ್ ಅಶೀಕ್, ಕೆ.	20NCJC827

Kaushalya 10/10/2022  
ಶಿಲ್ಪಿ ಆಡಳಿತಾಧಿಕಾರಿ

ಮಾನವ ಸಂಪನ್ಮೂಲ ಅಭಿವೃದ್ಧಿ ಕೇಂದ್ರ,  
ಕೆ.ಪಿ.ಪ್ರ.ಸಿ.ನಿ. ಹಬ್ಬಿ, ಬೆಂಗಳೂರು

*[Handwritten Signature]*

PRINCIPAL  
The National College  
Bangalore, Bangalore-70



### ಪ್ರತಿಗಳು:

1. ಡಾ. ಕೆ. ರಾ. ಪ್ರದೀಪ್, ನಿಯಂತ್ರಣಾಧಿಕಾರಿ(ಲೆಕ್ಕಗಳು ಪಿಂಚಣಿ ಮತ್ತು ಮುಂಗಡ), ಕೆವಿಪ್ರಸಿ.ನಿ, ಕಾಲೇರಿ ಭವನ, ಬೆಂಗಳೂರು.
2. ಮುಖ್ಯಸ್ಥರು, ವಿ ನ್ಯಾಷನಲ್ ಕಾಲೇಜ್, ಬೆಂಗಳೂರು.
3. ಸಂಬಂಧಪಟ್ಟ ವಿದ್ಯಾರ್ಥಿ/ ಸಿ.ಕಾ.ಸಿ.ಇಂ(ಎ)-2/ ಕೆ.ಪ್ರ./ ಮು.ಕ.



## PROJECT COMPLETION LETTER

Date: 17.04.2023

### TO WHOMSOEVER IT MAY CONCERN

This is to certify that **Mr. Muhammad Ashik. K** bearing **Reg. No. 20NCJC827** of VI Semester B.Com student, The National College, Autonomous, Jayanagar, Bangalore has successfully completed the project work for the period of 04 weeks **18.04.2023 to 18.05.2023** under the guidance of **Mr. NASAR (Manager)** at our organisation towards the fulfilment of award of "Bachelor of Commerce" during the year 2022-23.

The title of his project work was **A Study on the impact of E-Commerce on Retail market ShopRite hypermarket.**

During the period of his project with us he has exhibited punctuality and diligence. We wish him every success in life.

Thanking you

**SHOPRITE HYPERMARKET**

Mr. NASAR (Manager)  
283, Puttalingiah road  
Near Carmel school  
Padmanabhanagar  
Bangalore- 560070

PRINCIPAL  
The National College  
Jayanagar, Bangalore-70





# Karnataka Bank Ltd.

Estd.: 1924



KARNATAKA BANK LTD.  
No. 75, Opp. Sobha Silicon Oasis Aptmt,  
Doddanagamangala Road, Vinayak Nagar,  
Naganaathapura, Electronic City Post,  
Bangalore-560100.

BRANCH NAGANAATHAPURA  
BANGALORE-560100

Date

Your Ref.

Our Ref.

## TO WHOMSOEVER IT MAY CONCERN

This is to certify that Mr. MANOJ K bearing Reg. No. 20NCJC825 of VI Semester B.Com student, The National College, Autonomous, Jayanagar, Bangalore has successfully completed the project work for the period of 04 weeks (3<sup>rd</sup> April to 29<sup>th</sup> April) under the guidance of (Shashikanth, Manager) at our organization towards the fulfilment of award of "Bachelor of Commerce" during the year 2022-23.

The title of his project work was Role Bank Finance in growth of MSME sector.

During the period of his project with us he has exhibited punctuality and diligence. We wish him every success in life.

Thanking you.

For, Karnataka Bank Limited  
For KARNATAKA BANK LTD.

  
Branch Manager  
Naganaathapura Branch

  
PRINCIPAL  
The National College  
Jayanagar, Bangalore-70.



Regd. & Head Office : Mangalore - 575 002, India

# Karnataka Bank Ltd.

Estd.: 1924



KARNATAKA BANK LTD.  
No. 75, Opp. Sobha Silicon Oasis Aptmt,  
Doddanagamangala Road, Vinayak Nagar,  
Bangalore-560100.

BRANCH NAGANAATHAPURA  
BANGALORE-560104

Date

Your Ref.

Our Ref.

## TO WHOMSOEVER IT MAY CONCERN

This is to certify that Mr. MANOJ K bearing Reg. No. 20NCJC825 of VI Semester B.Com student, The National College, Autonomous, Jayanagar, Bangalore has successfully completed the project work for the period of 04 weeks (3<sup>rd</sup> April to 29<sup>th</sup> April) under the guidance of (Shashikanth, Manager) at our organization towards the fulfilment of award of "Bachelor of Commerce" during the year 2022-23.

The title of his project work was Role Bank Finance in growth of MSME sector.

During the period of his project with us he has exhibited punctuality and diligence. We wish him every success in life.

Thanking you.

For, Karnataka Bank Limited  
For KARNATAKA BANK LTD.

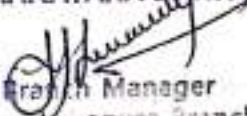
  
Branch Manager  
Naganaathapura Branch

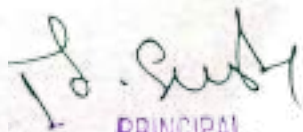
  
PRINCIPAL  
The National College  
Jayanagar, Bangalore-70.



Regd. & Head Office : Mangalore - 575 002, India

## INTERNSHIP COMPLETION CERTIFICATE

This is to certify that Mr. MANJU S, Reg No.20NCJC824, B.Com Final Year student of The National College, Autonomous, Jayanagar, Bangalore has successfully completed internship of 24 days under the guidance of Mr Ashok Savanth (Store Manager) at this organization (*Tanishq Bannerghatta Road*), towards the fulfillment of the award of 'Bachelor of Commerce' during the year 2022-23.

During the period of his/her internship he/she has exhibited punctuality and diligence. We wish his/her every success in life.

*Ashok Savanth*



(Authorized signature with seal)

Date:

Place:

*D. Sush*  
PRINCIPAL  
The National College  
Jayanagar, Bangalore-70





**TO WHOMSOEVER IT MAY CONCERN**

This is to certify that Mr. Manju. S, bearing Reg.No. 20NCJC824 of VI Semester B.Com student, The National College, Autonomous, Jayanagar, Bangalore has successfully completed the project work for the period of 6 weeks, From 15/05/2023 to 17/06/2023 under the guidance of (DHARAMVEER, MARKETING HEAD) at our organisation towards the fulfilment of award of "Bachelor of Commerce" during the year 2022-23.

The title of his project work was effects of good public relation & organization promotion achievement of marketing object

During the period of his project with us he has exhibited punctuality and diligence. We wish his every success in life.

Thank you,

For,

Reliance Mart

*Dharam Veer*

**RELIANCE RETAIL LIMITED**  
Bhartiya City Centre, Thanisandra,  
Bangalore, Kamataka - 560 077

*D. Sush*  
PRINCIPAL  
The National College  
Jayanagar, Bangalore-70.



**Reliance Retail Ventures Limited**

CIN: U51909MH2006PLC1661 Phone: +91 22 35553800

Registered office: 4<sup>th</sup> Floor, court House, Lokmanya task Mang Dhobi, Mumbai-400 002. India



## PROJECT COMPLETION LETTER

DATE:

### TO WHOMSOEVER IT MAY CONCERN

This is to certify that Mr. MADHU G bearing Reg. No. 20NCJC823 of VI Semester B.Com student, The National College, Autonomous, Jayanagar, Bangalore has successfully completed the project work for the period of 06 weeks on 22 MAY 2023 under the guidance of MAHESH K Human resources BRITANNIA at our organisation towards the fulfilment of award of "Bachelor of Commerce" during the year 2022-23.

The title of his/her project work was " FINANCIAL ANALYSIS OF BRITANNIA INDUSTRIES" .

During the period of his project with us he has exhibited punctuality and diligence. We wish him every success in life.

Thanking you.

For, BRITANNIA

Authorised signator

PRINCIPAL

The National College  
Jayanagar, Bangalore-70.





## PROJECT COMPLETION LETTER

DATE:

### TO WHOMSOEVER IT MAY CONCERN

This is to certify that Mr. MADHU G bearing Reg. No. 20NCJC823 of VI Semester B.Com student, The National College, Autonomous, Jayanagar, Bangalore has successfully completed the project work for the period of 06 weeks on 22 MAY 2023 under the guidance of MAHESH K Human resources BRITANNIA at our organisation towards the fulfilment of award of "Bachelor of Commerce" during the year 2022-23.

The title of his/her project work was " FINANCIAL ANALYSIS OF BRITANNIA INDUSTRIES" .

During the period of his project with us he has exhibited punctuality and diligence. We wish him every success in life.

Thanking you.

For, BRITANNIA

Authorised signator

PRINCIPAL

The National College  
Jayanagar, Bangalore-70.





# **SRSV AGRO COMPANY**

# 19, Plat Form Road  
Bengaluru - 560 020  
Ph : 080-23566055  
Mob : 9108150223

## **INTERNSHIP COMPLETION CERTIFICATE**

This is to certify that Mr.Mallesh B, Register No.20NCJC822, B.com Final Year student of The National College, Autonomous, Jayanagar, Bangalore has Successfully Completed Internship of 06 days Under the Guidance of \_\_\_\_\_ At Tanishq Vegacity Caratlane, Towards the fulfillment of the award of 'Bachelor of Commerce' during the year of 2022 - 23.

During the period of his internship he exhibited punctuality and diligence. We wish his every success in life.

Date :02/11/2022

Place:Bangalore



Hr-Executive

Tanishq Jayanagar

For SRSV AGRO COMPANY

Partner



PRINCIPAL  
The National College  
Jayanagar, Bangalore-70



Show Room : Vega City Mall, Unit No. G-10, No. 172/1, Srinivasa Industrial Estate  
Bannerghatta Road, Bengaluru - 560 076

Mobile : 990281500

# P. C. M. DENTAL SUPPLY

DENTAL MATERIALS, INSTRUMENTS & EQUIPMENTS  
#1, 2nd Main, 3rd Cross, Chamarajpet, Near Bata Show Room, BANGALORE-560 018.  
Email : pcmentalsupply@gmail.com

Date : .....

Ref. No. :

## PROJECT COMPLETION LETTER

### TO WHOMSOEVER IT MAY CONCERN

This is to certify that Mr./Ms. MALLESH.B bearing Reg. No. 20NCJC822 of VI Semester B.Com student, The National College, Autonomous, Jayanagar, Bangalore has successfully completed the project work for the period of 06 weeks (6/4/2023 TO 15/5/2023) under the guidance of (SHUBHA SAGAR.H - B.COM GRADUATE) at our organisation towards the fulfilment of award of "Bachelor of Commerce" during the year 2021-22.

The title of his/her project work was : The impact of sales promotion on marketing of new product and services.

During the period of his/her project with us he/she has exhibited punctuality and diligence. We wish him/her every success in life.

Thanking you.

For P.C.M. DENTAL SUPPLY

N. Sathya  
Proprietor

Authorised signatory with company seal

  
PRINCIPAL  
The National College  
Jayanagar, Bangalore-70.



## INTERNSHIP COMPLETION CERTIFICATE

This is to certify that Ms. Madhu shree P, Register No.20NCJC821, B.com Final Year student of The National College, Autonomous, Jayanagar, Bangalore has Successfully Completed Internship of 16 days Under the Guidance of *Anagha* At Tanishq Vegacity Caratlane, Towards the fulfillment of the award of 'Bachelor of Commerce' during the year of 2022 - 23.

During the period of her internship she exhibited punctuality and diligence. We wish her every success in life.

Date :02/11/2022

Place:Bangalore



Hr-Executive

Tanishq Jayanagar

SRSV AGRO COMPANY

Partner



PRINCIPAL  
The National College  
Jayanagar, Bangalore-70





# CORETECENGINEERINGINDIA PVT. LTD.

(Subsidiary of Yuken India Limited)



## Registered Works:

B.S.S. Hyderabad Industrial  
Estate, Whitefield Road,  
Maddur, Bangalore  
552455  
E-Mail

Plant-4, P.O. No. 263, 263 & 264,  
Malur III Rd, Phase Industrial  
Area, Kadu Road No. 7, Malur  
Taluk, Malur, Kolar District -563130  
Karnataka (India) Mobile No: +91-9740702948  
Email: Rajaraman.de@Coretecengg.com

## TO WHOMEVER IT MAY CONCERN

This is to certify that **Ms. MADHUSHREE** bearing Reg. No. 20NCJCS21 of VI Semester B Com student, The National College, Autonomous, Jayanagar, Bangalore has successfully completed the project work for the period of 06 weeks 12th April 2023 to 22st May 2023 under the guidance of Mr. Kantha, Manager at our Organization towards the fulfilment of award of "Bachelor of Commerce" during the year 2022-23.

The title of her project work was "A Study On Impact Of Mechanisation On Labour Turnover"

During the period of her project with us she has exhibited punctuality and diligence. We wish her every success in life.

Thanking you,

For

Coretec Engineering Pvt. Ltd

For: CORETEC ENGG. INDIA PVT. LTD \*

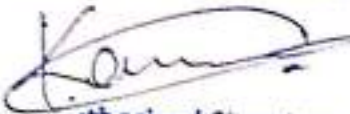
  
Authorized Signatory

  
PRINCIPAL  
The National College  
Jayanagar, Bangalore-70.





# ಕರ್ನಾಟಕ ವಿದ್ಯುತ್ ಪ್ರಸರಣ ನಿಗಮ ನಿಯಮಿತ

ನಿಗಮದ ಗುರುತಿನ ಸಂಖ್ಯೆ (ಸಿ.ಎ.ಎಸ್): ಯು40109ಕಎ99ಎಸ್‌ಎಸಿ025521

ಮಾನವ ಸಂಪನ್ಮೂಲ ಅಭಿವೃದ್ಧಿ ಕೇಂದ್ರ, ವೈಟ್‌ಫೀಲ್ಡ್ ರಸ್ತೆ, ಹೂಡಿ ಬೆಂಗಳೂರು-560 048

ದೂರವಾರ್ತೆ ಸಂಖ್ಯೆ : 080-28540666

www.kptel.karnataka.gov.in

ಇ-ಮೇಲ್ ವಿಳಾಸ [adminhrdckptel@gmail.com](mailto:adminhrdckptel@gmail.com)

ಸಂಖ್ಯೆ ಕವಿಪ್ರನಿ/ಮಾ.ಸಂ.ಅ.ಕೇಂದ್ರ/ಬಿ75/35590/22-23/1330-32

ದಿನಾಂಕ : 1 OCT 2022

## ಅಧಿಕೃತ ಜ್ಞಾಪನಾ ಪತ್ರ

ವಿಷಯ: "General Finance" ವಿಷಯದ ಕುರಿತಂತೆ ಕವಿಪ್ರನಿ ನಿಂದ ತರಬೇತಿಯನ್ನು ಮಾಡಲು ಅನುಮೋದನೆಯನ್ನು ನೀಡುವ ಬಗ್ಗೆ.

ಉಲ್ಲೇಖ: ದಿ ನ್ಯಾಷನಲ್ ಕಾಲೇಜ್, ಬೆಂಗಳೂರು ರವರ ಪತ್ರ ದಿನಾಂಕ: 20.09.2022

\*\*\*\*\*

ದಿ ನ್ಯಾಷನಲ್ ಕಾಲೇಜ್, ಬೆಂಗಳೂರಿನಲ್ಲಿ ಐ.ಕಾಂ ಪದವಿಯಲ್ಲಿ ವ್ಯಾಸಂಗ ಮಾಡುತ್ತಿರುವ ಈ ಕೆಳಕಂಡ ವಿದ್ಯಾರ್ಥಿಯು ಶ್ರೀ ಕೆ. ಇ. ಪ್ರದೀಪ್, ನಿಯಂತ್ರಣಾಧಿಕಾರಿ(ಲೆಕ್ಕಗಳು ಮತ್ತು ಮುಂಗಡ), ಕವಿಪ್ರನಿ, ಕಾವೇರಿ ಭವನ, ಬೆಂಗಳೂರು ರವರ ಮಾರ್ಗದರ್ಶನದಲ್ಲಿ "General Finance" ಎಂಬ ವಿಷಯದ ಕುರಿತಂತೆ, ದಿನಾಂಕ: 03.10.2022 ರಿಂದ 15.11.2022 ರವರೆಗೆ ತರಬೇತಿಯನ್ನು ಪಡೆಯಲು ಈ ಕೆಳಗಿನ ಪರಾಕುಗಳಿಗೆ ಒಳಪಟ್ಟಂತೆ ಅನುಮೋದನೆಯನ್ನು ನೀಡಲಾಗಿದೆ.

- ಸದರಿ ತರಬೇತಿಯು ಯಾವುದೇ ರೀತಿಯಲ್ಲೂ ಕವಿಪ್ರನಿಯ ನಿಯಮಿತ ಕರ್ತವ್ಯಗಳನ್ನು ಅಡ್ಡಿಪಡಿಸಬಾರದು.
- ತರಬೇತಿ ಗಳಿಸಿದ ವಿದ್ಯಾರ್ಥಿಯು, ತರಬೇತಿಯು ಮುಗಿದ ನಂತರ ಅದರ ಮುಕ್ತಾಯ ಪದವಿಯನ್ನು ಕಾಲೇಜಿನ ಆಂತರಿಕ ಮಾರ್ಗದರ್ಶಕರ ಸಹಿ, ಕವಿಪ್ರನಿಯ ಮಾರ್ಗದರ್ಶಕರ ಸಹಿ ಮತ್ತು ವಿದ್ಯಾರ್ಥಿಯ ಸಹಿಯನ್ನು ಒಳಗೊಂಡು ಈ ಕಛೇರಿಗೆ ಸಲ್ಲಿಸತಕ್ಕದ್ದು.
- ನಿಗದಿತ 'ಎ' ನಮೂನೆಯಲ್ಲಿ ಕವಿಪ್ರನಿಯ ಮಾರ್ಗದರ್ಶಕರು ಸಹಿ ಮಾಡಿದ ತರಬೇತಿಯ ಪರಿಶೀಲನಾ ಮತ್ತು ಪೂರ್ಣಗೊಂಡ ದೃಢೀಕರಣ ಪತ್ರವನ್ನು ಈ ಕಛೇರಿಗೆ ಸಲ್ಲಿಸಿದ ನಂತರ, ಸಂಬಂಧಪಟ್ಟ ಕಾಲೇಜಿಗೆ ವಿದ್ಯಾರ್ಥಿಯ ತರಬೇತಿಯ ಪೂರ್ಣಗೊಂಡ ಬಗ್ಗೆ, ಈ ಕಛೇರಿಯಿಂದ ಪ್ರಮಾಣ ಪತ್ರವನ್ನು ನೀಡಲಾಗುವುದು.

ಕ್ರಮ ಸಂ	ವಿದ್ಯಾರ್ಥಿನಿಯರ ಹೆಸರು	ಯು.ಎಸ್.ಎನ್/ನೋಂದಣಿ ಸಂಖ್ಯೆ
1	ಕಿಶೋರ್. ಜಿ. ಎಂ.	20NCJC819

Kaushal 11/10/2022  
a/c ಆಡಳಿತಾಧಿಕಾರಿ

ಮಾನವ ಸಂಪನ್ಮೂಲ ಅಭಿವೃದ್ಧಿ ಕೇಂದ್ರ,  
ಕವಿಪ್ರನಿ, ಹೂಡಿ, ಬೆಂಗಳೂರು

PRINCIPAL

The National College,  
Jayanagar, Bangalore-70.



ಪ್ರತಿಗಳು:

1. ಶ್ರೀ ಕೆ. ಇ. ಪ್ರದೀಪ್, ನಿಯಂತ್ರಣಾಧಿಕಾರಿ(ಲೆಕ್ಕಗಳು ಮತ್ತು ಮುಂಗಡ), ಕವಿಪ್ರನಿ, ಕಾವೇರಿ ಭವನ, ಬೆಂಗಳೂರು.
2. ಮುಖ್ಯಸ್ಥರು, ದಿ ನ್ಯಾಷನಲ್ ಕಾಲೇಜ್, ಬೆಂಗಳೂರು.
3. ಸಂಬಂಧಪಟ್ಟ ವಿದ್ಯಾರ್ಥಿ/ ಸ.ಕಾ.ನಿ.ಇಂ(ಎ)-2/ ಕ.ಪ್ರ./ ಮು.ಕ.



ভাৰতীয় ষ্টেট বেঙ্ক  
भारतीय स्टेट बैंक  
State Bank Of India

The Chief Manager/Branch manager  
State Bank of India  
Branches - Bangalore  
Ref. No. R-I/HR/2022-23

Date:

TO WHOMSOEVER IT MAY CONCERN

This is to certify that Mr. KISHORE GM bearing Reg. No. 20NCJC819 of VI Semester B.Com student, The National College, Autonomous, Jayanagar, Bangalore has successfully completed the project work for the period of 06 weeks from 24 April 2023 to 06 June 2023 under the guidance of Mr.JAY PRAKASH BRANCH MANAGER at our organization towards the fulfilment of award of "Bachelor of Commerce" during the year 2022-23.

The title of his project work was "STUDY ON NON-PERFORMING ASSETS IN STATE BANK OF INDIA".

During the period of his project with us he has exhibited punctuality and diligence. We wish him every success in life.

Thanking you.

For, STATE BANK OF INDIA



*J. S. Sush*  
PRINCIPAL  
The National College  
Jayanagar, Bangalore-70



Authorised signatory



# SRSV AGRO COMPANY

# 8/69, 'Prabhat Complex'  
Kempegowda Road  
Bengaluru - 560 009

## INTERNSHIP COMPLETION CERTIFICATE

This is to certify that Mr.Karthik S , Register No.20NCJC817, B.com Final Year student of The National College, Autonomous, Jayanagar, Bangalore has Successfully Completed Internship of 18 days Under the Guidance of Mr. Kishan At Mia Tanishq Jayanagar, Towards the fulfillment of the award of 'Bachelor of Commerce' during the year of 2022 - 23.

During the period of his internship he exhibited punctuality and diligence. We wish his every success in life.

Date :02/11/2022

Place:Bangalore



Hr-Executive

Tanishq Jayanagar

For SRSV AGRO COMPANY

Partner

  
PRINCIPAL  
The National College  
Jayanagar, Bangalore-70.



**PROJECT COMPLETION LETTER**

Date: 22/5/23

TO WHOMSOEVER IT MAY CONCERN

This is to certify that **Mr./Ms. KARTHIK S** bearing Reg. No. 20NCJC817 of VI Semester B.Com student, The National College, Autonomous, Jayanagar, Bangalore has successfully completed the project work for the period of 06 weeks on **22 MAY 2023** under the guidance of **BHANU PRAKASH (HR) DECATHLON** at our organisation towards the fulfilment of award of "**Bachelor of Commerce**" during the year 2022-23.

The title of his/her project work was "**THE IMPACT OF E-COMMERCE IN EMERGING MARKET**" [Decathlon]

During the period of his project with us he has exhibited punctuality and diligence. We wish him every success in life.

Thanking you.

For, **DECATHLON**

  
Authorised Signatory

  
PRINCIPAL  
The National College  
Jayanagar, Bangalore-70.



# MOBILES TYRE TECH

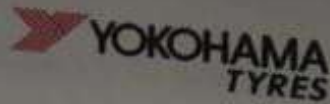

Kammanhalli Main road, St Thomas Town Post, Bangalore-560084  
Off: 080-25452916 / 25426465

E-mail: [mobilestiretech@gmail.com](mailto:mobilestiretech@gmail.com)

[www.mobilestiretech.co](http://www.mobilestiretech.co) [www.mobilestiretech.in](http://www.mobilestiretech.in)

REF.

DATE.....

## CERTIFICATE

This is to certify that Mr. KARAN G FROM THE NATIONAL COLLEGE JAYNAGAR Bangalore karnataka has successfully completed his project during 8<sup>th</sup> june to 10<sup>th</sup> july 2023. This project was undertaken by him in MOBILES TYRE TECH (YOKOHAMA) titled as "WORKING CAPITAL". This project on evaluation fulfills all the stated criteria and the student's finding are his original work.

I hereby certify that his work was excellent to the best of my knowledge.

We wish him all the best in his future endeavors.

For Mobiles Tyre Tech

Proprietor

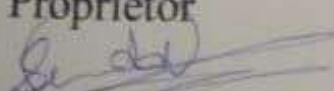
  
Senior Manager

  
PRINCIPAL  
The National College  
Jaynagar, Bangalore-70

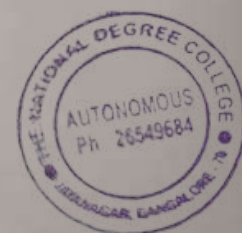



# MOBILES TYRE TECH

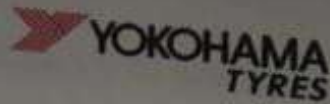

Kammanhalli Main road, St Thomas Town Post, Bangalore-560084  
Off: 080-25452916 / 25426465

E-mail: [mobilestiretech@gmail.com](mailto:mobilestiretech@gmail.com)

[www.mobilestyretech.co](http://www.mobilestyretech.co) [www.mobilestyretech.in](http://www.mobilestyretech.in)

REF.

DATE.....

## CERTIFICATE

This is to certify that Mr. KARAN G FROM THE NATIONAL COLLEGE JAYNAGAR Bangalore karnataka has successfully completed his project during 8<sup>th</sup> june to 10<sup>th</sup> july 2023. This project was undertaken by him in MOBILES TYRE TECH (YOKOHAMA) titled as "WORKING CAPITAL". This project on evaluation fulfills all the stated criteria and the student's finding are his original work.

I hereby certify that his work was excellent to the best of my knowledge.

We wish him all the best in his future endeavors.

For Mobiles Tyre Tech

Proprietor

  
Senior Manager

  
PRINCIPAL  
The National College  
Jaynagar, Bangalore-70

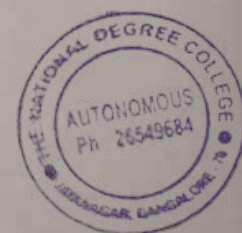



# HARINI HATCHERIES & FARMS PVT LTD.

## ACCEPTANCE LETTER

Date: 26/09/2022

To  
Dr. N K Satya Pal Sharma  
HODs Department of Commerce  
The National College  
Autonomous  
Jayanagar, Bangalore- 70

Dear Sir,

**Subject: Internship Acceptance Letter - Harshitha M K**  
Reg. No.20NCJC815

This is to certify that Ms. Harshitha M K, Reg No.20NCJC815, has joined our organization on 26<sup>th</sup> September, 2022 and she will be working as internship trainee in our Company Harini Hatcheries & Farms Pvt Ltd. for the period of 45 days.

Thanks with regards

For Harini Hatcheries & Farms Pvt. Ltd.

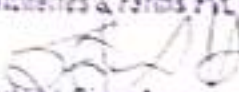
  
Authorized Signatory

  
PRINCIPAL  
The National College  
Jayanagar, Bangalore-70.



# PARAMOUNT

EXPECT MORE...

PROJECT COMPLETION LETTER

27 May 2023

TO WHOMSOEVER IT MAY CONCERN

This is to certify that Ms. HARSHITHA M K bearing Reg. No. 20NCJC815 of VI Semester B.Com student, The National College, Autonomous, Jayanagar, Bangalore has successfully completed the project work for the period of 06 weeks on 17 APRIL 2023 TO 27 MAY 2023 under the guidance of MR. SATHVIK P PARAMOUNT INDUSTRIES PVT LTD at our organization towards the fulfillment of the award of "Bachelor of Commerce" during the year 2022-23.

The title of her project work was "A PROJECT ON RECRUITMENT SELECTION PROCESS OF PARAMOUNT INDUSTRIES PVT. LTD".

During the period of her project with us she has exhibited punctuality and diligence. We wish her every success in life.

Thank you.



PARAMOUNT INDUSTRIES  
No. 87, 3rd Cross, Electronic City Phase 1,  
Bangalore - 560100

*[Signature]*  
PRINCIPAL  
The National College  
Jayanagar, Bangalore-70





## INTERNSHIP COMPLETION CERTIFICATE

This is to certify that Mr.HARIPRASAD KS, Reg No.20NCJC814, B.Com Final Year student of The National College, Autonomous, Jayanagar, Bangalore has successfully completed internship of 10 days under the guidance of Mr Ashok Savanth (Store Manager)at this organization (*Tanishq Bannerghatta Road*), towards the fulfillment of the award of '*Bachelor of Commerce*' during the year 2022-23.

During the period of his/her internship he/she has exhibited punctuality and diligence. We wish his/her every success in life.

  
  
(Authorized signature with seal)

Date:

Place:

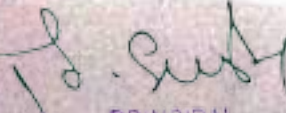
  
PRINCIPAL  
The National College  
Jayanagar, Bangalore-70



## PROJECT COMPLETION LETTER

This is to certify that Mr. **HARI PRASAD K S** Bearing Reg. No. **20NCJC814** of VI Semester B. Com student, The National College, Autonomous, Jayanagar, Bangalore has successfully completed the project work for the period of 04 weeks commencing from 02/05/2023 to 31/05/2023 under the guidance of Mr. **VISHNU SURESH** at our organization towards the fulfillment of award of "Bachelor of Commerce" during the year 2022-23.

The title of his/her project work was: **GREEN BANKING** in **PUNJAB NATIONAL BANK**.

During the period of his project with us he has exhibited punctuality and diligence. We wish him every success in life.

Thanking you.

ਮੁੱਖ ਪੰਜਾਬ ਨੈਸ਼ਨਲ ਬੈਂਕ  
For Punjab National Bank

ਮੁਖੀ, Manager  
ਸੀ. ਐਚ. ਰੋਡ ਬੰਚ, ਇੰਦਰਨਗਰ ਬੰਗਲੁਰ-35  
CMH Road Branch, Indiranagar Bangalore-35



*V. Suresh*  
PRINCIPAL  
The National College  
Jayanagar, Bangalore-70

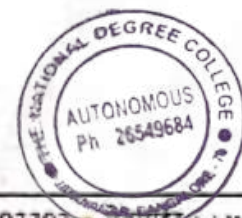

# SRSV AGRO COMPANY

# 8/69, 'Prabhat Complex'  
Kempgowda Road  
Bengaluru - 560 009

## INTERNSHIP COMPLETION CERTIFICATE

This is to certify that Mr. Harshavardhan Rao N , Register No.20NCJC813, B.com Final Year student of The National College, Autonomous, Jayanagar, Bangalore has Successfully Completed Internship of 18 days Under the Guidance of At Tanishq Caratlane Jayanagar, Towards the fulfillment of the award of 'Bachelor of Commerce' during the year of 2022 - 23.

During the period of his internship he exhibited punctuality and diligence. We wish his every success in life.

Date :02/11/2022

Place:Bangalore

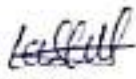
  
Hr-Executive

Tanishq Jayanagar

  
PRINCIPAL

For SRSV Agro Company  
The National College  
Jayanagar, Bangalore-70

Partner



Show Room : No. 83/2, 9th Main Road, 4th Block, Jayanagar, BENGALURU - 560 011

Mob : 7338273383



**PROJECT COMPLETION LETTER**

**TO WHOMSOEVER IT MAY CONCERN**

This is to certify that Mr./Ms. HARSHAVARDHAN RAO N bearing Reg. No. 20NCJC813 of VI Semester B.Com student, The National College, Autonomous, Jayanagar, Bangalore has successfully completed the project work for the period of 06 weeks under the guidance of Mr.Vishwanath Rao at our organisation towards the fulfilment of award of "Bachelor of Commerce" during the year 2022-23.

The title of his/her project work was Consumer Perception towards Social Media Marketing.

During the period of his/her project with us he/she has exhibited punctuality and diligence. We wish him/her every success in life.

Thanking you.

For,

VSM Software and Digital Media Technologies

Authorised signatory with company seal



*[Handwritten Signature]*  
PRINCIPAL  
The National College  
Jayanagar, Bangalore-70.





Innovation has a name.

Plot No. 300, Phase – 2, KIADB Industrial Area, Harohalli, Taluka Kanakpura, Karnataka – 562112

**TO WHOMSOEVER IT MAY CONCERN**

This is to certify that Mr. **Dhanush.M** bearing Reg. No **20NCJC812** of VI Semester B.Com student, The National College, Autonomous, Jayanagar, Bangalore has successfully completed the project work for the period of 06 weeks 2/5/2023 to 30/5/2023 under the guidance of **JAGGA REDDY – MARKETING HEAD** at our organisation towards the fulfilment of award of "Bachelor of Commerce" during the year 2021-22.

The title of his project work was **Marketing plan and budget**

During the period of his project with us he has exhibited punctuality and diligence. We wish him every success in life.

Thanking you.



Authorised signatory with company seal

*[Handwritten Signature]*  
PRINCIPAL  
The National College  
Jayanagar, Bangalore-70



## INTERNSHIP COMPLETION CERTIFICATE

This is to certify that Mr. DILIP S, Reg No. 20NCJC811, B.Com Final Year student of The National College, Autonomous, Jayanagar, Bangalore has successfully completed internship of 10 days under the guidance of Mr Ashok Savanth (Store Manager) at this organization (*Tanishq Bannerghatta Road*), towards the fulfillment of the award of 'Bachelor of Commerce' during the year 2022-23.

During the period of his/her internship he/she has exhibited punctuality and diligence. We wish his/her every success in life.

(Authorized signature with seal)

Date:

Place:

  
PRINCIPAL  
The National College  
Jayanagar, Bangalore-70







**TO WHOMSOEVER IT MAY CONCERN**

This is to certify that Mr. Dilip. S, bearing Reg.No. 20NCJC811 of VI Semester B.Com student, The National College, Autonomous, Jayanagar, Bangalore has successfully completed the project work for the period of 6 weeks, From 17/04/2023 to 20/05/2023 under the guidance of (NEERAJ SHARMA) at our organisation towards the fulfilment of award of "Bachelor of Commerce" during the year 2022-23

**The title of his project work was Market survey of McDonald's**

During the period of his project with us he has exhibited punctuality and diligence. We wish his every success in life.

Thank you,

For,

McDonald's

*D. S. Subramanian*  
PRINCIPAL  
The National College  
Jayanagar, Bangalore-70.  
A circular stamp of The National Degree College, Autonomous, Jayanagar, Bangalore, Ph 26549684.

**S.J.S. Enterprises Limited**

Formerly known as S.J.S. Enterprises Private Limited  
Sj No. 28 Pk of Agra Village and Sj No. 89/79  
of BM Rural Village, Kengeri Hoob, Bangalore-560072  
P. +91 80 41647771 F. +91 80 28425112  
Email: info@pushkarak.com compliance@pushkarak.com

ISO 14001 ISO 45001  
ISO 9001 SAIF 16949  
Certified  
CIN: U51907KA2007PLC036601  
www.sjsindia.com



SJS/HRM/PRJ CER/F36/ - R3834

December 13, 2022

**TO WHOM IT MAY CONCERN**

This is to certify that Ms. Deeksha C Reg no: 20NCJC810 student of of 5th Semester B Com from The National Degree College Jayanagar .She has successfully completed his Project titled "Organizations Study" Starting from 10-10-2022 to 04-11-2022.

Deeksha C displayed a professional character during his project and completed all her assigned tasks, during her project program with us, She was found self-motivated, hardworking, and inquisitive.

We wish her all the best for future endeavours.

For SJS Enterprises Limited,

*S. Umadevi*  
S. Umadevi  
AGM - HR & Admin



*D. Sudh*  
PRINCIPAL  
The National College  
Jayanagar, Bangalore-70.





**PROJECT COMPLETION LETTER  
TO WHOMSOEVER IT MAY CONCERN**

This is to certify that Mr./Ms. Deeksha C bearing Reg. No. 20NCJC810 of VI Semester B. Com student, The National College, Autonomous, Jayanagar, Bangalore has successfully completed the project work for the period of 06 weeks 02/05/2023 to 31/05/2023 under the guidance of Vijayakumar accounts manager of External guide at our organisation towards the fulfilment of award of "Bachelor of Commerce" during the year 2021-22.

The title of his/her project work was Employment welfare benefits.

During the period of his/her project with us he/she has exhibited punctuality and diligence. We wish him/her every success in life.

Thanking you.

For, Greenchef Appliances Limited

Authorised signatory



*[Signature]*  
PRINCIPAL

The National College  
Jayanagar, Bangalore-70

**Greenchef Appliances Limited**

HEAD OFFICE: No. 477E, 12th Cross, 3rd Main Road, Peenya, 4th Phase, Opp. Bata Factory,  
Next to Shivapura Lake, Bengaluru, Karnataka - 560058

CIN No: U29300KA2010PLC05411B







# Swemed Biomedicals Pvt. Ltd.

29/1 first floor, Chunchanaghatta Cross, Yelachenahalli, Bengaluru 560062

## ACCEPTANCE LETTER

DATE: 9/10/2022

To  
Dr. N K Satya Pal Sharma  
HOD- Department of Commerce  
The National College  
Autonomous  
Jayanagar, Bangalore- 70

Dear sir,

**Subject: Internship Acceptance Letter – DARSHAN.N.S. Reg No: 20NCJC809**

This is to certify that **Mr. DARSHAN.N.S. Reg. No. 20NCJC809** has joined in our organization on 9/10/2022 and he will be working as internship trainee in our **SWEMED Biomedicals Pvt. Ltd.** for the period of 45 days.

Thanking You

With Regards

For SWEMED Biomedicals Pvt. Ltd.

For SWEMED BIOMEDICALS PVT. LTD

*Kumar*

Authorised signatory

HR Manager

*D. S. S.*  
PRINCIPAL  
The National College  
Jayanagar, Bangalore-70



**TO WHOMSOEVER IT MAY CONCERN**

This is to certify that Mr. Darshan N.S, bearing Reg.No. 20NCJC809 of VI Semester B.Com student, The National College, Autonomous, Jayanagar, Bangalore has successfully completed the project work for the period of 6 weeks, From 15/05/2023 to 17/06/2023 under the guidance of (JULIE GONSALVAS, MARKETING HEAD) at our organisation towards the fulfilment of award of "Bachelor of Commerce" during the year 2022-23.

**The title of his project work was Impact of branding on consumer purchasing behavior with reliance trends**

During the period of his project with us he has exhibited punctuality and diligence. We wish his every success in life.

Thank you,

For,  
Reliance Trends

  
**RELiance RETAIL LIMITED**  
Bhartiya City Centre, Thanisandra,  
Bangalore, Karnataka - 560 077

  
**PRINCIPAL**  
**The National College**  
Jayanagar, Bangalore-70.





**Aurz Pharmaceutical Pvt. Ltd.**  
.....*Promise for a Healthy Growth*

GIN-U24231KA2007PTC044290

GST No : 29AAGCA6157R1ZV

Corporate Office :  
No. 85, Sri Shesha Jayamahala  
Top Floor, H Cross, Ideal Homes Township  
2nd Stage, Rajarajeshwarinagar  
Bangalore - 560 058  
Mob. : +91 9008988121 Ph : 080 29743655  
E-mail : aurzpharmaceutical@gmail.com

## INTERNSHIP COMPLETION CERTIFICATE

Date: 20-11-2022

**Sub: Internship Completion Certificate Letter – Chethan S – Reg. No. 20NCJC808**

This is to certify that Mr. Chethan S, Reg. No. 20NCJC808, B.Com Final Year Student of The National College, Autonomous, Jayanagar, Bangalore has successfully completed internship of six weeks under the guidance of Malleesh.K at this Organization, towards the fulfillment of the award of "Bachelor of Commerce" during the year 2022-23.

During the period of his Internship he has exhibited punctuality and diligence. We wish his every success in life.

With Regards,

Aurz Pharmaceutical Pvt., Ltd.,

Authorised Signatory



Date : 28-02-2023

Place : Bangalore

PRINCIPAL  
The National College  
Jayanagar, Bangalore-70.







**Aurz Pharmaceutical Pvt Ltd.**  
..... Promise for a Healthy Growth

Corporate office: No.85, Sri  
Shesha Jayamahal, Top Floor,  
H Cross, Ideal Homes, 2nd  
stage Rajarajeshwari nagar,  
Banglore - 560098

## COMPLETION LETTER

This is to certify that Mr. **CHETHAN S** bearing Reg. No. **20NCJC808** of VI Semester B.Com student, The National College, Autonomous Jayanagar, Bangalore has successfully completed the project work for the period of 06 weeks April 25<sup>th</sup> to May 31<sup>st</sup> under the guidance **MALLESH K (ACCOUNTANT)** at our organisation towards the fulfilment of award of "Bachelor of Commerce" during the year 2023.

The title of his project work was **Brand Awareness** in Aurz Pharmaceutical Pvt Ltd Company.

During the period of his project with us he has exhibited punctuality and diligence. We wish him every success in life.

Thanking you.

AURZ PHARMACEUTICAL PRIVATE LIMITED COMPANY ,



*[Handwritten signature]*  
PRINCIPAL  
The National College  
Jayanagar, Bangalore-70.



Authorised signatory with company seal



ಬೆಂಗಳೂರು ನಗರ, ಬೆಂಗಳೂರು ಗ್ರಾಮಾಂತರ ಹಾಗೂ ರಾಮನಗರ  
ಜಿಲ್ಲಾ ಸಹಕಾರ ಹಾಲು ಉತ್ಪಾದಕರ ಸಂಘಗಳ ಒಕ್ಕೂಟ ನಿಯಮಿತ, ಬೆಂಗಳೂರು-29  
Bengaluru Urban, Bengaluru Rural & Ramanagara  
District Co-operative Milk Producers' Societies Union Ltd., Bengaluru-29



PMF 12004 - 2014  
CERTIFIED DAIRY



No.Bamul/Admn-10/cert/N-38(vol I)/2022-23

Date:08.12.2022

### CERTIFICATE

This is to certify that **Ms.Chandanashree.G(Reg No.20NCJc807)** The National College B.Com., part of Curriculum has undertaken Project entitled as **“Working Capital Management”** at Bengaluru Urban, Bengaluru Rural and Ramanagara District Co-operative milk producer's Societies Union Ltd., during 10.10.2022 to 23.11.2022

**General Manager(Admn)**  
**Bengaluru Co-Op Milk Union Ltd.,**

**PRINCIPAL**  
**The National College**  
**Jayanagar, Bangalore-70.**



## INTERNSHIP COMPLETION CERTIFICATE

This is to certify that Mr.Chandan V , Register No.20NCJC806, B.com Final Year student of The National College, Autonomous, Jayanagar, Bangalore has Successfully Completed Internship of 18 days Under the Guidance of At Tanishq Caratlane Jayanagar, Towards the fulfillment of the award of 'Bachelor of Commerce' during the year of 2022 - 23.

During the period of his internship he exhibited punctuality and diligence. We wish his every success in life.

Date :02/11/2022

Place:Bangalore



Hr-Executive

Tanishq Jayanagar

For SRSV AGRO COMPANY



PRINCIPAL

The National College  
Jayanagar, Bangalore-70



Partner



## PROJECT COMPLETION LETTER

DATE:

### TO WHOMSOEVER IT MAY CONCERN

This is to certify that Mr./Ms. CHANDAN.V bearing Reg. No.20NCJC806 of VI Semester B.Com student, The National College, Autonomous, Jayanagar, Bangalore has successfully completed the project work for the period of 06 weeks on 22 MAY 2023 under the guidance of KIRTI SHARMA Human resources paytm at our organisation towards the fulfilment of award of "Bachelor of Commerce" during the year 2022-23.

The title of his/her project work was "STUDY ON RETAILERS PERCEPTION OVER PAYTM TECHNOLOGY".

During the period of his/her project with us he has exhibited punctuality and diligence. We wish him every success in life.

Thanking you.

For, PAYTM

### One97 Communication

533, 22nd A Main Rd, 2nd floor Agara Village,  
1st Sector, HSR Layout, Bengaluru,  
Karnataka 560102

  
Authorised signatory

  
PRINCIPAL  
The National College  
Jayanagar, Bangalore-70



Date: 03<sup>rd</sup> November 2022.

**TO WHOM SO EVER IT MAY CONCERN**

Dear Sir/Madam,

This is to certify that Ms. Bhavana G M (Reg No: 20NCJC805) from National College Jayanagar Bangalore - 560070 has completed the internship in our organisation in Human Resource department from "20<sup>th</sup> Sept 2022 to 03<sup>rd</sup> November 2022."

During his Project work stay in the organisation, her character was found good.

We wish Mr. Bhavana G M all the best for his future Endeavour.

For METRO Cash and Carry India Pvt Ltd



HR Department-DC11

Authorised signature

  
PRINCIPAL  
The National College  
Jayanagar, Bangalore-70.



**METRO**

Cash & Carry India

YOUR SUCCESS IS OUR BUSINESS

## TAX CONSULTANT

### TO WHOM SO EVER IT MAY CONCERN

This is to certify that Ms. Anusha. N bearing Reg. No. 20NCJC803 of VI Semester B.Com student, The National College, Autonomous, Jayanagar, Bangalore has successfully completed the project work for the period of 4 weeks, From 20/05/2023 to 12/06/2023 under the guidance of Nagesh at our organisation towards the fulfilment of award of "Bachelor of Commerce" during the year 2022-23.

**The title of her project work was GST & Income Tax Filing.**

During the period of her project with us she has exhibited punctually and diligence. We wish her every success in life.

Thanking you.

For.

GST & Income Tax Filing



*[Handwritten Signature]*  
PRINCIPAL  
The National College  
Jayanagar, Bangalore-70.



**GST & Income Tax Filing**

No.2 1<sup>st</sup> Floor, BMTC Bus Stand, in GST Office, HAL old Airport RD, Domlur, Bengaluru,  
Karnataka 560071



## TAX CONSULTANT

### TO WHOM SO EVER IT MAY CONCERN

This is to certify that Ms. Anusha. N bearing Reg. No. 20NCJC803 of VI Semester B.Com student, The National College, Autonomous, Jayanagar, Bangalore has successfully completed the project work for the period of 4 weeks, From 20/05/2023 to 12/06/2023 under the guidance of Nagesh at our organisation towards the fulfilment of award of "Bachelor of Commerce" during the year 2022-23.

**The title of her project work was GST & Income Tax Filing.**

During the period of her project with us she has exhibited punctually and diligence. We wish her every success in life.

Thanking you.

For.

GST & Income Tax Filing



*[Signature]*  
PRINCIPAL  
The National College  
Jayanagar, Bangalore-70.



**GST & Income Tax Filing**

No.2 1<sup>st</sup> Floor, BMTC Bus Stand, in GST Office, HAL old Airport RD, Domlur, Bengaluru,  
Karnataka 560071

## INTERNSHIP COMPLETION CERTIFICATE

This is to certify that Mr.ABHISHEK VR, Reg No.20NCJC802, B.Com Final Year student of The National College, Autonomous, Jayanagar, Bangalore has successfully completed internship of 16 days under the guidance of Mr Ashok Savanth (Store Manager) at this organization (*Tanishq Bannerghatta Road*), towards the fulfillment of the award of '*Bachelor of Commerce*' during the year 2022-23.

During the period of his/her internship he/she has exhibited punctuality and diligence. We wish his/her every success in life.

*Ashok Savanth*



(Authorized signature with seal)

Date:

Place:

*D. Sush*

PRINCIPAL  
The National College  
Jayanagar, Bangalore-70.



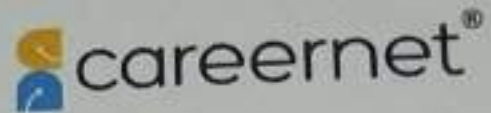

19<sup>th</sup> Jul 2023

**TO WHOMSOEVER IT MAY CONCERN**

This is to certify that **Mr. Abhishek V R**, a student of **The National College Autonomous, Jayanagar, Bangalore**. Pursuing **B. COM** has successfully completed the project with **Careernet Technologies Pvt. Ltd.**, for academic purposes.

**Below are the details of the project:**

Project Title: **Talent Branding**

Project Duration: **22<sup>nd</sup> May 2023 to 13<sup>th</sup> Jun 2023**

We appreciate the efforts made by him for the project and extend our best wishes for his future endeavors.

For **Careernet Technologies Pvt. Ltd.**

Digitally signed by  
**KAVITHA S**  
Date: 2023.07.20 17:01:37  
+05'30'

**Kavitha S**  
**Vice President -HR**

*[Handwritten Signature]*  
**PRINCIPAL**

**The National College**  
**Jayanagar, Bangalore-70**

Corporate Office: Careernet Technologies Pvt. Ltd.,  
Kanyamma Agrahara Road, Devanahalli,  
Outer Ring Road, Bellandur Post, Bengaluru 560103



www.careernet.in

CONFIDENTIAL



CIN :U51909KA2010PTC055001

## INTERNSHIP COMPLETION CERTIFICATE

This is to Certify that **Mr. ABHISHEK K. Reg. No. 20NCJC801**, B.Com Final Year student of the National College, Autonomous, Jayanagara, Bengaluru has successfully completed **internship of 45 days** under the guidance of Mr. Chethan Kumar B (Accounts Manager) at this organization (Newwill Biotech Pvt Ltd), towards the fulfillment of the award of 'Bachelor of Commerce' during the year 2022-23.

During the period of his internship he has exhibited punctuality and diligence. We wish his every success in life.

For Newwill Biotech Pvt Ltd

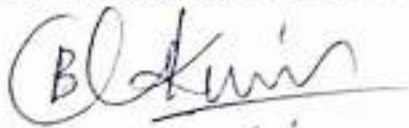

(Authorized Signature with seal)

Date : 07.11.2022

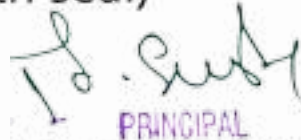

Place : Bengaluru

PRINCIPAL  
The National College  
Jayanagar, Bangalore-70.



CIN :U51909KA2010PTC055001

## INTERNSHIP COMPLETION CERTIFICATE

This is to Certify that **Mr. ABHISHEK K. Reg. No. 20NCJC801**, B.Com Final Year student of the National College, Autonomous, Jayanagara, Bengaluru has successfully completed **internship of 45 days** under the guidance of Mr. Chethan Kumar B (Accounts Manager) at this organization (Newwill Biotech Pvt Ltd), towards the fulfillment of the award of 'Bachelor of Commerce' during the year 2022-23.

During the period of his internship he has exhibited punctuality and diligence. We wish his every success in life.

For Newwill Biotech Pvt Ltd

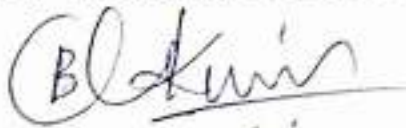

(Authorized Signature with seal)

Date : 07.11.2022



PRINCIPAL  
The National College  
Jayanagar, Bangalore-70.

Place : Bengaluru







# Briskon

TRANSFORM WITH AGILITY

NO.38/5, Berlie Street,  
Langford Town, Hosur Road,  
Bengaluru - 560078

Ref:

Date: 11/06/2023

**PROJECT COMPLETION LETTER**  
**TO WHOMSOEVER IT MAY CONCERN**

This is to certify that Mr. Abhishek.K bearing Reg. No. 20NCJC801 of VI Semester B.Com student, The National College, Autonomous, Jayanagar, Bangalore has successfully completed the project work for the period of 04 weeks 10/05/2023 to 10/06/2023 under the guidance of Mr. Hemanth (Accounts Manager) at our organization towards the fulfilment of award of "Bachelor of Commerce" during the year 2021-22.

The title of his project work was: A Study on Revenue recognition in Briskon Technologies Pvt Ltd.

During the period of his project with us he has exhibited punctuality and diligence. We wish him every success in life.

Thanking you.

**Briskon Technologies Pvt Ltd.**

For Briskon Technologies Pvt Ltd

  
Authorised Signatory

Authorised signatory

  
PRINCIPAL  
The National College  
Jayanagar, Bangalore-70.





## Experience Letter

Date: 10/08/2023

### To Whom It May Concern

This letter is to certify that Tejas V has worked as Data Science Intern in various proof-of-concepts and client projects during the internship program with Rubixe from 29/4/2023 to PRESENT.

During this internship period, we found Tejas V has hardworking, diligent, and delivered the tasks assigned in time.

*Deepak*

Deepak ( Aug 10 , 2023 16:58 GMT+5.5)

Sincerely,

Deepak Dongere,

Director

  
PRINCIPAL  
The National College  
Jayanagar, Bangalore-70.



## Experience Letter

Date: 10/08/2023

### To Whom It May Concern

This letter is to certify that Tejas V has worked as Data Science Intern in various proof-of-concepts and client projects during the internship program with Rubixe from 29/4/2023 to PRESENT.

During this internship period, we found Tejas V has hardworking, diligent, and delivered the tasks assigned in time.

*Deepak*

Deepak ( Aug 10 , 2023 16:58 GMT+5.5)

Sincerely,

Deepak Dongere,

Director

  
PRINCIPAL  
The National College  
Jayanagar, Bangalore-70.



## Experience Letter

Date: 10/08/2023

### To Whom It May Concern

This letter is to certify that Tejas V has worked as Data Science Intern in various proof-of-concepts and client projects during the internship program with Rubixe from 29/4/2023 to PRESENT.

During this internship period, we found Tejas V has hardworking, diligent, and delivered the tasks assigned in time.

*Deepak*

Deepak ( Aug 10 , 2023 16:58 GMT+5.5)

Sincerely,

Deepak Dongere,

Director

  
PRINCIPAL  
The National College  
Jayanagar, Bangalore-70.







## Certificate of Internship

This is to certify

**Suraj MJ**

---

of **National College**

Has successfully started an internship of 3 months on project **Maven**  
from 3<sup>rd</sup> April 2023 with **Datazymes Analytics Private Limited**



Authorized Signatory  
**Amith Mohandas**

  
PRINCIPAL  
The National College  
Jayanagar, Bangalore-70





## Certificate of Internship

This is to certify

**Suraj MJ**

---

of **National College**

Has successfully started an internship of 3 months on project **Maven**  
from 3<sup>rd</sup> April 2023 with **Datazymes Analytics Private Limited**



Authorized Signatory  
**Amith Mohandas**

  
PRINCIPAL  
The National College  
Jayanagar, Bangalore-70





## Certificate of Internship

This is to certify

**Suraj MJ**

---

of **National College**

Has successfully started an internship of 3 months on project **Maven**  
from 3<sup>rd</sup> April 2023 with **Datazymes Analytics Private Limited**



Authorized Signatory  
**Amith Mohandas**

  
PRINCIPAL  
The National College  
Jayanagar, Bangalore-70.





## Internship Certificate

This is to certify that SAI KIRAN . V a student of THE  
NATIONAL COLLEGE, JAYANAGAR has completed 3 months/weeks of Internship  
From 15-05-2023 To 15-08-2023 in MACHINE LEARNING Domain.

We wish you all the best in your future endeavors.

Date : 15-08-2023

  
PRINCIPAL

The National College  
TechnoFly Solutions, Vijayanagar, Bangalore - 40.  
Mob.: 9842176588, 9741150102 | www.technofly.in

For TechnoFly Solutions



## Internship Certificate

This is to certify that SAI KIRAN . V a student of THE  
NATIONAL COLLEGE , JAYANAGAR has completed 3 months/weeks of Internship  
From 15-05-2023 To 15-08-2023 in MACHINE LEARNING Domain.

We wish you all the best in your future endeavors.

Date : 15-08-2023

  
PRINCIPAL

The National College  
TechnoFly Solutions, Vijayanagar, Bangalore - 40.  
Mob.: 9842176588, 9741150102 | www.technofly.in

For TechnoFly Solutions



# TechnoFly Solutions

Techno fly

## Internship Certificate

This is to certify that SAI KIRAN . V a student of THE  
NATIONAL COLLEGE , JAYANAGAR has completed 3 months/weeks of Internship  
From 15-05-2023 To 15-08-2023 in MACHINE LEARNING Domain.

We wish you all the best in your future endeavors.

Date : 15-08-2023

*[Handwritten Signature]*  
PRINCIPAL

The National College  
TechnoFly Solutions, Vijayanagar, Bangalore - 40.  
Mob.: 9842176588, 9741150102 | www.technofly.in

For TechnoFly Solutions





# TechnoFly Solutions



TechnoFly

## Internship Certificate

This is to certify that REHAN KHAN · A a student of THE  
NATIONAL COLLEGE, JAYANAGAR has completed 3 months/weeks of Internship  
From 20-5-2023 To 20-8-2023 in MACHINE LEARNING Domain.

We wish you all the best in your future endeavors.

Date : 15-08-2023

For TechnoFly Solutions

  
PRINCIPAL  
TechnoFly Solutions, Vijayanagar, Bangalore - 40.  
Mob.: 9849143697 | 9849143698 | www.technofly.in  
Jayanagar, Bangalore-70.



# TechnoFly Solutions



TechnoFly

## Internship Certificate

This is to certify that REHAN KHAN · A a student of THE  
NATIONAL COLLEGE, JAYANAGAR has completed 3 months/weeks of Internship  
From 20-5-2023 To 20-8-2023 in MACHINE LEARNING Domain.

We wish you all the best in your future endeavors.

Date : 15-08-2023

For TechnoFly Solutions



PRINCIPAL

TechnoFly Solutions, Vijayanagar, Bangalore - 40.  
Mob.: 9849143697 | 9849143698 | www.technofly.in  
Jayanagar, Bangalore-70.



19NCJC839

**BLUE DART**

EXPRESS LIMITED  
Manipal road dwaraka nagar near,  
century indus apartment RR nagar,  
Bangalore - 560098.  
[www.bluedart.com](http://www.bluedart.com)  
Communications@bluedart.com

**TO WHOMSOEVER IT MAY CONCERN**

This is to certify that Mr. PAVAN KUMAR S.N bearing Reg. No.19NCJC839 of VI Semester B.com student, The National College, Autonomous, Jayanagar, Bangalore has successfully completed the project work for the period of 06 weeks 28<sup>th</sup> March 2023 to 12<sup>th</sup> May 2023 under the guidance of Shilpa N, Manager at our organisation towards the fulfilment of award of "Bachelor of Commerce" during the year 2022-23.

The title of his project work was "A Project Study on International Logistics with Special Reference to Blue Dart".

During the period of his project with us he has exhibited punctuality and diligence. We wish him every success in life.

Thanking you,

For (BLUE DART EXPRESS LIMITED)



*S. S. S.*  
PRINCIPAL  
The National College  
Jayanagar, Bangalore-70.





**Jesta Healthcare India Pvt. Ltd.**

CIN : U74900KA2014PTC074930

**Regd. Office :**

#19/14, Ground Floor, 28th Cross, Jayanagar 7th Block  
(Near Metro Station), Bangalore - 560 082, INDIA.

Mobile : +91 88844 42625

E-mail : jesta.healthcare@gmail.com

www.jestahealthcare.com

## INTERNSHIP COMPLETION CERTIFICATE

This is to certify that Pavan Kumar S N Reg No. 19NCJC839, B.Com Final Year student of The National College, Autonomous, Jayanagar, Bangalore has successfully completed internship of six weeks under the guidance of - Aishwarya Shetty at this organization, towards the fulfillment of the award of 'Bachelor of Commerce' during the year 2022-23.

During the period of his internship he has exhibited punctuality and diligence. We wish his every success in life.



Date: 31-10-2022

Place: Bangalore



PRINCIPAL  
The National College  
Jayanagar, Bangalore-70.



# ELITE AGRO SPECIALITIES

## TO WHOMSOEVER IT MAY CONCERN

This is to certify that Ms. Roopa. A, bearing Reg.No. 19NCJC848 of VI Semester B.Com student, The National College, Autonomous, Jayanagar, Bangalore has successfully completed the project work for the period of 6 weeks, From 22/05/2023 to 14/06/2023 under the guidance of Bhagya at our organisation towards the fulfilment of award of "Bachelor of Commerce" during the year 2022-23.

**The title of her project work was Role of packaging on consumer buying behaviour**

During the period of her project with us she has exhibited punctuality and diligence. We wish her every success in life.

Thanking you.

For,  
ELITE AGRO SPECIALITIES



  
PRINCIPAL  
The National College  
Jayanagar, Bangalore-70.

**ELITE AGRO SPECIALITIES**  
CIN: U85190TG2023PTC087417

14/19 SIDCO Industrial Estate, P.O. Peringandoor, Thrissur, kerala – 680 581 – 2204305, 2204816,  
2204817



# Swemed Biomedicals Pvt. Ltd.

## TO WHOMSOEVER IT MAY CONCERN

This is to certify that Mr. Venu. L, bearing Reg.No. 19NCJC858 of VI Semester B.Com student, The National College, Autonomous, Jayanagar, Bangalore has successfully completed the project work for the period of 6 weeks, From 15/05/2023 to 17/06/2023 under the guidance of (HR MANAGER, KUMAR SHARMA) at our organisation towards the fulfilment of award of "Bachelor of Commerce" during the year 2022-23.

The title of his project work was the Effectiveness of marking, planning and controlling in organization

During the period of his project with us he has exhibited punctuality and diligence. We wish his every success in life.

Thank you,

For,  
Swemed Biomedicals Pvt. Ltd

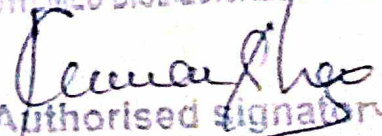
OF SWEMED BIOMEDICALS PVT. LTD  
  
Authorised signatory



  
PRINCIPAL  
The National College  
Jayanagar, Bangalore-70.

CIN U31909KA2003PTC032979

29/1 first floor, Chunchanaghatta Cross, Yelachenahalli, Bengaluru 560062-08026551720





Bosch Limited  
Post Box. No. 3000  
Hosur Road, Aduugodi  
Bangalore - 560 030  
India  
www.boschindia.com  
CIN : L85110KA1951PLC000781

Tel. :

Fax :

Date

Your ref/date

Our ref

### TO WHOMSOEVER IT MAY CONCERN

This is to certify that Mr./Ms VIDYASHREE S bearing Reg. No 19NCJC859 of VI Semester B.Com student, The National College, Autonomous, Jayanagar, Bangalore has successfully completed the project work for the period of 06 weeks from 16/04/2023 to 27/05/2023 under the guidance of SHILPA KIRAN at our organisation towards the fulfilment of award of "Bachelor of Commerce" during the year 2022-23.

The title of his/her project work was SALES PROMOTION TOWARDS DIGITAL MARKETING.

During the period of his/her project with us he/she has exhibited punctuality and diligence. We wish him/her every success in life.

Thanking you.

**Bosch Limited**  
P.B. No. 3000  
Hosur Road, Aduugodi  
Bangalore-560,030  
FOR,  
*Shilpa*  
**BOSCH LIMITED**



*Dr. Sudy*  
PRINCIPAL  
The National College  
Jayanagar, Bangalore-70.



**SRI MAHESH TRAVELS**  
#13, 2nd Floor, opp State Bank of India, 4th Cross,  
Suddagunte palya, Tavarekere Main Road,  
Bangalore- 79. Ph: 080 40314321 Mob : 98895 52977  
E-mail: bookings@konnnectkarz.com  
www.konnnectkarz.com

## INTERNSHIP COMPLETION CERTIFICATE

This is to certify that Vidyashree S Reg No. 19NCJC859, B.Com Final Year student of The National College, Autonomous, Jayanagar, Bangalore has successfully completed internship of six weeks under the guidance of –  
\_\_\_\_\_ (external guide name) at this organization, towards the fulfillment of the award of 'Bachelor of Commerce' during the year 2022-23.

During the period of his/her internship he/she has exhibited punctuality and diligence. We wish his/her every success in life.

With Regards

  
For KONNECTKARZ

ACCOUNT MANAGER

GURUPRAKASH G

Date: 15.11.2022

Place: Bangalore



  
PRINCIPAL  
The National College  
Jayanagar, Bangalore-70.

**The National College, Jayanagar, Bangalore - 560070**



**॥ ಶ್ರದ್ಧಾಹಿ ಪರಮಾ ಗತಿಃ ॥**

**ESRAJ INSTRUMENT**

**MEGHANA.M**

**REG NO: 20NCJA031**

**Project Work submitted to Department of Journalism National College Jayanagar for  
the partial fulfilment of  
VI semester BA course in Journalism**

**THE NATIONAL COLLEGE JAYANAGAR (Autonomous)**

**Jayanagar Bangalore**



## CERTIFICATE

This is to certify that the Project entitled EMS on Urban and Rural Students was submitted by the candidate bearing Register Number. **20NCJA034** for the partial fulfilment of VI semester BA Psychology in National College Jayanagar is the product of Bonafide research work carried out by the candidate under supervision of Professors in the Department of Psychology, National College Jayanagar.

It is further certified that the candidate has fulfilled the basic project ordinance governing the submission of the project in the university.

**HOD**



**Prof Geetha Srinivas**

**Assistant Professor**

**Department of Psychology**

**National College Jayanagar**

**Guide**



**Prof Jayanth.M**

**Assistant Professor**

**Department of Psychology**

**National College Jayanagar**

**Head**  
Department of Psychology  
The National College  
Jayanagar, Bangalore - 70.

**Principal**



**Dr B. Suresha**

**National College Jayanagar**

**Principal**

**The National College  
Autonomous**

Jayanagar 7th Block,  
Bangalore - 560 070

## CERTIFICATE

This is to certify that the Project entitled Emotional maturity among the Middle adulthood and early adulthood was submitted by the candidate bearing Reg no. 20NCJA035 for the partial fulfilment of VI semester BA Psychology in National College Jayanagar is the product of Bonafede research work carried out by the candidate under supervision of Professors in the Department of Psychology, National College Jayanagar. It is further certified that the candidate has fulfilled the basic project ordinance governing the submission of the project in the university.

HOD Guide Prof Geetha Srinivas Prof Jayanth. M Assistant Professor Assistant Professor  
Department of Psychology Department of Psychology National College Jayanagar National  
College Jayanagar Principal B. SURESH National College Jayanagar

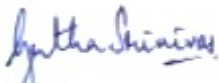
  
HOD

Prof Geetha Srinivas

Assistant Professor

Department of Psychology

National College Jayanagar

GUIDENCE

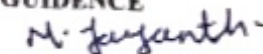
  
Prof Jayanth.M

Assistant Professor

Department of Psychology

National College Jayanagar

Head  
Department of Psychology  
The National College  
Jayanagar, Bangalore - 70.

  
Principal

B. SURESH

The National College Jayanagar  
Principal  
The National College  
Autonomous  
Jayanagar 70th block,  
Bangalore - 5-

## CERTIFICATE

This is to certify that the Project entitled EMS (emotional maturity scale) on pet owners and non-pet owners was submitted by the candidate bearing Reg no. 20NCJA036 for the partial fulfilment of VI semester BA Psychology in National College Jayanagar is the product of Bonafede research work carried out by the candidate under supervision of Professors in the Department of Psychology, National College Jayanagar.

It is further certified that the candidate has fulfilled the basic project ordinance governing the submission of the project in the university.

**HOD**



**Prof. Geetha Srinivas**

**Assistant Professor**

**Department of Psychology**

**National College Jayanagar**

**Guide**



**Prof. Jayanth.M**

**Assistant Professor**

**Department of Psychology**

**National College Jayanagar**

**Head**

**Department of Psychology**  
**The National College**  
**Jayanagar, Bangalore - 70.**

**Principal**



**B.SURESH**

**National College Jayanagar**

**Principal**  
**The National College**  
**Autonomous**  
**Jayanagar 7th Block,**  
**Bangalore - 560 07'**



## CERTIFICATE

This is to certify that the Project entitled EMS (emotional maturity scale) on sports Persons and non-sports persons was submitted by the candidate bearing Reg no. 20NCJA038 for the partial fulfilment of VI semester BA Psychology in National College Jayanagar is the product of Bonafede research work carried out by the candidate under supervision of Professors in the Department of Psychology, National College Jayanagar.

It is further certified that the candidate has fulfilled the basic project ordinance governing the submission of the project in the university.

**HOD**

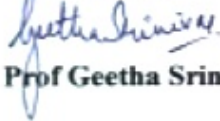

**Prof Geetha Srinivas**

**Assistant Professor**

**Department of Psychology**

**National College, Jayanagar**

**Head**  
**Department of Psychology**  
**The National College**  
**Jayanagar, Bangalore - 70.**

**Guide**

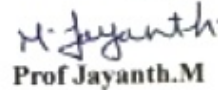

**Prof Jayanth.M**

**Assistant Professor**

**Department of**  
**Psychology**

**National College,**

**Principal**



**B.SURESH**

**National College Jayanagar**

**Principal**  
**The National College**  
**Autonomous**  
**Jayanagar 7th Block,**  
**Bangalore - 560 070**

## CERTIFICATE

This is to certify that the Project entitled ( Emotional maturity of managers and employees) was submitted by the candidate bearing Reg no. (20NCJA039) for the partial fulfilment of VI semester BA Psychology in National College Jayanagar is the product of Bonafede research work carried out by the candidate under supervision of Professors in the Department of Psychology, National College Jayanagar.

It is further certified that the candidate has fulfilled the basic project ordinance governing the submission of the project in the university.

**HOD**



**Prof Geetha Srinivas**

**Assistant Professor**

**Department of Psychology**

**National College Jayanagar**

**Guide**

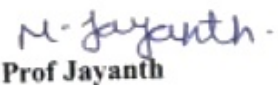

**Prof Jayanth**

**Assistant Professor**

**Department of Psychology**

**National College Jayanagar**

**Head**  
**Department of Psychology**  
**The National College**  
**Jayanagar, Bangalore - 70.**

**Principal**

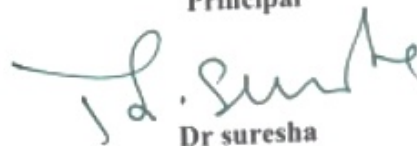

**Dr Suresha**

**National College Jayanagar**

**Principal**

**The National College**  
**Autonomous**

**Jayanagar 7th Block,**  
**Bangalore - 560 070**

## CERTIFICATE

This is to certify that the Project entitled 'Emotional Maturity of Working Mothers and Non-Working Mothers' was submitted by the candidate bearing Reg no. 20NCJA041 for the partial fulfilment of VI semester BA Psychology in National College Jayanagar is the product of Bonafede research work carried out by the candidate under supervision of Professors in the Department of Psychology, National College Jayanagar.

It is further certified that the candidate has fulfilled the basic project ordinance governing the submission of the project in the university.

**HOD**



**Prof Geetha Srinivas**

**Assistant Professor**

**Department of Psychology**

**National College Jayanagar**

**Guide**

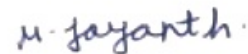

**Prof Jayanth.M**

**Assistant Professor**

**Department of Psychology**

**National College Jayanagar**

**Head**  
**Department of Psychology**  
**The National College**  
**Jayanagar, Bangalore - 70.**

**Principal**

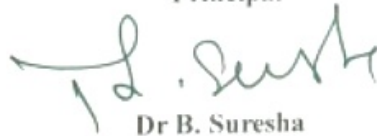

**Dr B. Suresha**

**National College Jayanagar**  
**Principal**  
**The National College**  
**Autonomous**  
**Jayanagar 7th Block,**  
**Bangalore - 560 070**



## CERTIFICATE

This is to certify that the Project titled "Emotional Maturity of First and Fourth Year Engineering Students" was submitted by the candidate bearing register number 20NCJA042 for the partial fulfillment of VI semester BA Psychology in National College Jayanagar is the product of bonafide research work carried out by the candidate under the supervision of the professors in the Department of Psychology, National College Jayanagar.

It is further certified that the candidate has fulfilled the basic project ordinance governing the submission of the project to the university.

**HOD**



**Prof Geetha Srinivas**

**Assistant Professor**

**Department of Psychology**

**National College Jayanagar**

**Guide**

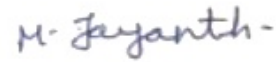

**Prof Jayanth M**

**Assistant Professor**

**Department of Psychology**

**National College Jayanagar**

**Head**  
**Department of Psychology**  
**The National College**  
**Jayanagar, Bangalore - 70.**

**Principal**

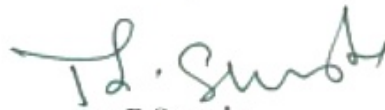

**Dr. B Suresha**

**National College Jayanagar**

**Principal**  
**The National College**  
**Autonomous**  
**Jayanagar 7th Block,**  
**Bangalore - 560 070**

## CERTIFICATE

This is to certify that the Project entitled ( emotional maturity ) was submitted by the candidate bearing Reg no. (20NCJA045) for the partial fulfilment of VI semester BA Psychology in National College Jayanagar is the product of Bonafede research work carried out by the candidate under supervision of Professors in the Department of Psychology, National College Jayanagar.

It is further certified that the candidate has fulfilled the basic project ordinance governing the submission of the project in the university.

**HOD**

  
Prof Geetha Srinivas

Assistant Professor  
Head

Department of Psychology  
The National College  
Jayanagar, Bangalore - 70.  
Department of Psychology

Psychology

National College Jayanagar

Jayanagar

**Guide**

  
Prof Jayanth.M

Assistant

Department of

National College

**Principal**

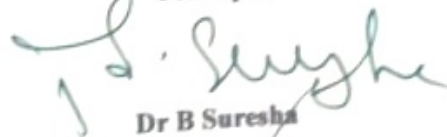
  
Dr B Suresha

National College Jayanagar

Principal

The National College  
Autonomous  
Jayanagar 7th Block  
Bangalore - 560070

## CERTIFICATE

This is to certify that the Project entitled Emotional maturity among the Rural college student and urban college student was submitted by the candidate bearing Reg no. 20NCJA046 for the partial fulfilment of VI semester BA Psychology in National College Jayanagar is the product of Bonafede research work carried out by the candidate under supervision of Professors in the Department of Psychology, National College Jayanagar. It is further certified that the candidate has fulfilled the basic project ordinance governing the submission of the project in the university.



HOD

Prof Geetha Srinivas

Assistant Professor

Department of Psychology

National College Jayanagar

Guide



Prof Jayanth.M

Assistant Professor

Department of Psychology

National College Jayanagar

Head  
Department of Psychology  
The National College  
Jayanagar, Bangalore - 70.



Principal

B. SURESH

National College Jayanagar

Principal

The National College  
Autonomous  
Jayanagar 7th Block,  
Bangalore - 560 070



## CERTIFICATE

This is to certify that the Project entitled (emotional maturity between mothers of exceptional child and mothers of normal child) was submitted by the candidate bearing Reg no. (20NCJA047) for the partial fulfilment of VI semester BA Psychology in National College Jayanagar is the product of Bonafede research work carried out by the candidate under supervision of Professors in the Department of Psychology, National College Jayanagar.

It is further certified that the candidate has fulfilled the basic project ordinance governing the submission of the project in the university.

**HOD**



**Prof Geetha Srinivas**

**Assistant Professor**

**Department of Psychology**

**National College Jayanagar**

**Guide**

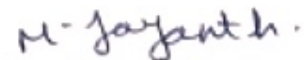

**Prof Jayanth.M**

**Assistant Professor**

**Department of Psychology**

**National College Jayanagar**

**Head**  
**Department of Psychology**  
**The National College**  
**Jayanagar, Bangalore - 70.**

**Principal**

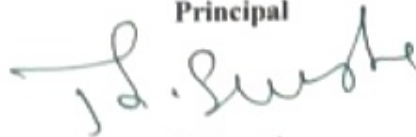

**B. Suresh**

**National College Jayanagar**  
**Principal**  
**The National College**  
**Autonomous**  
**Jayanagar 7th Block,**  
**Bangalore - 560 070**

## CERTIFICATE

This is to certify that the Project entitled (emotional maturity between day scholars and hostelites) was submitted by the candidate bearing Reg no. (20NCJA048) for the partial fulfilment of V\semester BA Psychology in National College Jayanagar is the product of Bonafede research work carried out by the candidate under supervision of Professors in the Department of Psychology, National College Jayanagar.

It is further certified that the candidate has fulfilled the basic project ordinance governing the submission of the project in the university.

**HOD**



**Prof Geetha Srinivas**

**Assistant Professor**

**Department of Psychology**

**National College Jayanagar**

Head  
Department of Psychology  
The National College  
Jayanagar, Bangalore - 70.

**Guide**

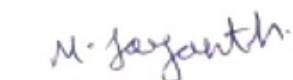

**Prof Jayanth.M**

**Assistant Professor**

**Department of Psychology**

**National College Jayanagar**

**Principal**



**B. Suresh**

**National College Jayanagar**

**Principal**

**The National College  
Autonomous  
Jayanagar 7th Block,  
Bangalore - 560 070**

## CERTIFICATE

This is to certify that the Project entitled Emotional Maturity Scale of the individual with and without siblings was submitted by the candidate bearing Reg no. 20NCJA049 for the partial fulfilment of VI semester BA Psychology in National College Jayanagar is the product of Bonafede research work carried out by the candidate under supervision of Professors in the Department of Psychology, National College Jayanagar.

It is further certified that the candidate has fulfilled the basic project ordinance governing the submission of the project in the university.

**HOD**



**Prof Geetha Srinivas**

**Assistant Professor**

**Department of Psychology**

**National College Jayanagar**

**Head**  
Department of Psychology  
The National College  
Jayanagar, Bangalore - 70.

**Guide**

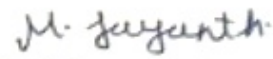

**Prof Jayanth. M**

**Assistant Professor**

**Department of Psychology**

**National College Jayanagar**

**Principal**



**Dr. B. Suresh**

**National College Jayanagar**

**Principal**

The National College  
Autonomous  
Jayanagar 7th Block,  
Bangalore - 560 070



## CERTIFICATE

This is to certify that the Project entitled "Nuclear family and Joint family adolescents" was submitted by the candidate bearing Reg no. 20NCJA050 for the partial fulfilment of VI semester BA Psychology in National College Jayanagar is the product of Bonafide research work carried out by the candidate under supervision of Professors in the Department of Psychology, National College Jayanagar.

It is further certified that the candidate has fulfilled the basic project ordinance governing the submission of the project in the university.

**HOD**



**Prof Geetha Srinivas**

**Assistant Professor**

**Department of Psychology**

**National College Jayanagar**

**Guide**

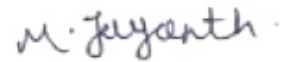

**Prof Jayanth.M**

**Assistant Professor**

**Department of Psychology**

**National College Jayanagar**

**Head**  
**Department of Psychology**  
**The National College**  
Jayanagar, Bangalore - 70.

**Principal**

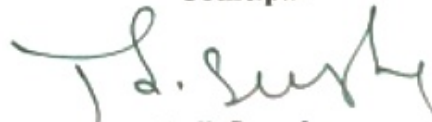

**Dr B Suresha**

**National College Jayanagar**

**Principal**  
**The National College**  
Autonomous  
Jayanagar 7th Block,  
Bangalore - 560 070

## CERTIFICATE

This is to certify that the Project entitled "Emotional Maturity of Recently Married Women and Women Married for Longer Duration" was submitted by the candidate bearing Reg no. 20NCJA051 for the partial fulfillment of VI semester BA Psychology in National College Jayanagar is the product of Bonafede research work carried out by the candidate under the supervision of Professors in the Department of Psychology, National College Jayanagar.

It is further certified that the candidate has fulfilled the basic project ordinance governing the submission of the project to the university.

**HOD**



**Prof Geetha Srinivas**

**Assistant Professor**

**Department of Psychology**

**National College Jayanagar**

**Head**  
**Department of Psychology**  
**The National College**  
**Jayanagar, Bangalore - 70.**

**Guide**

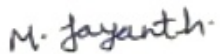

**Prof Jayanth.M**

**Assistant Professor**

**Department of Psychology**

**National College Jayanagar**

**Principal**



**Dr. B Suresha**

**National College Jayanagar**

**Principal**  
**The National College**  
**Autonomous**  
**Jayanagar 7th Block,**  
**Bangalore - 560 070**





॥ ಶ್ರದ್ಧಾಹಿ ಪರಮಾ ಗತಿಃ ॥

**THE NATIONAL COLLEGE**  
**Autonomous**  
**Jayanagar, Bangalore-560070**

**PROJECT REPORT**  
**ON**  
**HYPERLEDGER FABRIC BLOCKCHAIN BASED**  
**CBFTIG APPLICATION**

**BY**

**KS Barath Vikramam**

**20NJB403**

**Under the guidance of**

**Prof. VARADARAJ**

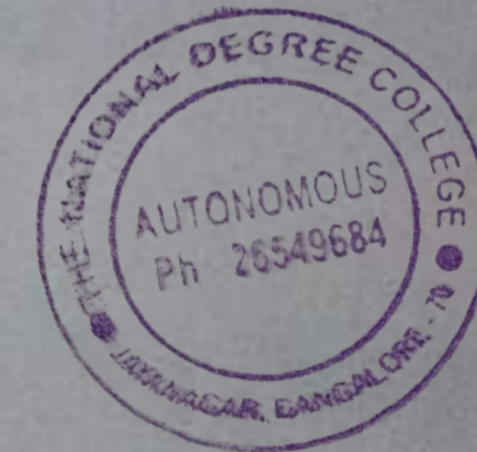

*[Signature]*  
**PRINCIPAL**  
The National College  
Jayanagar, Bangalore-70

**CBFTIG project report submitted in partial fulfilment of the requirements**  
**of**

**VI Semester BCA, THE NATIONAL COLLEGE JAYANAGAR**





॥ ಶ್ರದ್ಧಾಹಿ ಪರಮಾ ಗತಿಃ ॥

**THE NATIONAL COLLEGE**  
**Autonomous**  
**Jayanagar, Bangalore-560070**

**CERTIFICATE**

This is to certify the project report titled "CBFTIG Application" is a work done by **KS Barath Vikraman** of THE NATIONAL COLLEGE, Jayanagar, Bengaluru, in partial fulfilment of the requirements of VI Semester BCA during the year 2022-2023.

  
**HEAD OF THE DEPARTMENT**

Head, Dept. of Comp. Science  
The National Degree College  
(Autonomous)  
Jayanagar, Bangalore - 560 070

**Examiners:**

1.

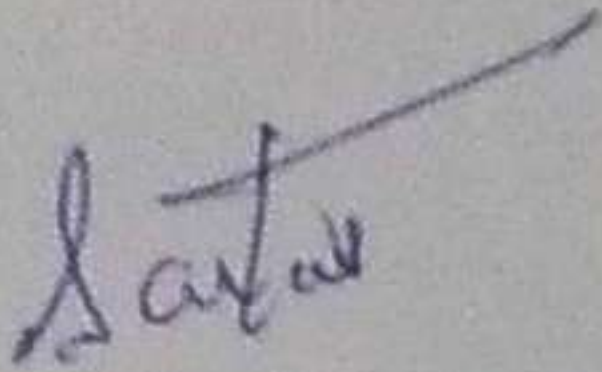

2.

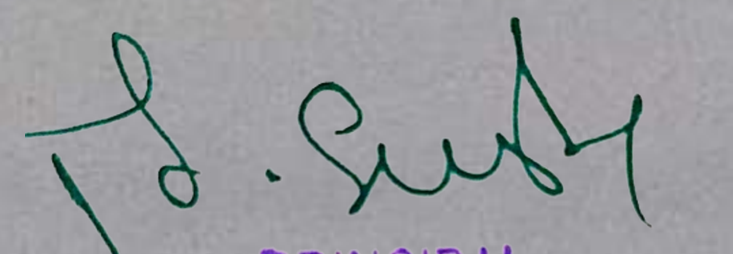
  
PRINCIPAL  
The National College  
Jayanagar, Bangalore-70.

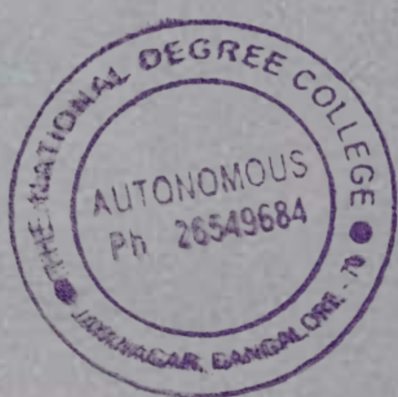

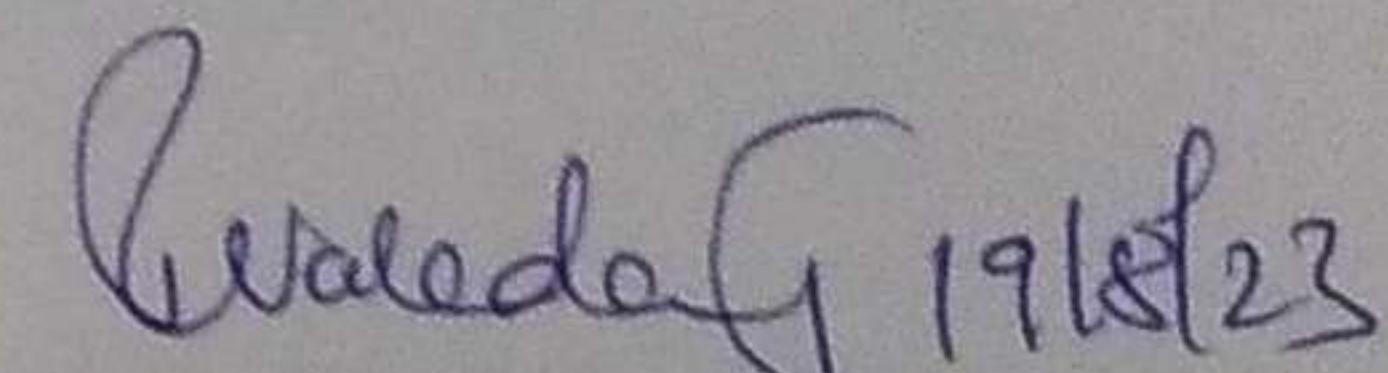
  
**PROJECT GUIDE**

**Examination Centre**

**The National College,  
Jayanagar.**

**Date of Examination: 22/8/23**



## ACKNOWLEDGEMENT

CBFTIG Application is the project of many hands from the team. Our tribute for the successful completion of the project goes to all those who helped through their constant guidance and encouragement. The satisfaction that accompanies the success would be incomplete without thanking the person who made it.

I am thankful to our beloved Principal **Dr.B SURESHA**, who encourages us to come with new and innovative ideas and for providing the environment with all facilities for completing the project.

I am are also grateful to our Head of the Department **Prof. ASHA TS** Department of computer science for her valuable guidance and constant support during our project development.

I am are also grateful to our project guide **Prof. VARADARAJ**, lecturer Department of computer science for his valuable guidance and constant support during our project development.

A special thanks to **MUTHURAM GOVINDARASU**, CEO and Founder of Indigeneous Tech Private Limited, Bangalore-32 with 10 years of experience in Blockchain for his valuable guidance and technical support for our project.

I extend our thanks to all our teaching staffs of the department of computer science. Finally, we thank one and all who helped us directly and indirectly for the completion of our project.



## Table of Contents

<b>I</b>	<b>Project Goal (Problem Statement)</b> .....	7
<b>II</b>	<b>Solution Proposed</b> .....	7
<b>III</b>	<b>Input Data and Verification</b> .....	10
<b>IV</b>	<b>Project/ Solution (C.BFTW) Design</b> .....	12
<b>V</b>	<b>Tools/ Technologies Used</b> .....	17
<b>VI</b>	<b>Project Team Members</b> .....	17
<b>VII</b>	<b>Referenced Documents</b> .....	18
<b>VIII</b>	<b>Project / Solution Setup</b> .....	18
1)	<b>AWS free-tier Account and EC2 Instance creation and connection</b> .....	18
a)	Create an AWS free-tier account and further create an EC2 instance with Ubuntu Operating System AMI .....	18
b)	Connect to the AWS EC2 Instance through "PuTTY" Software and open the Terminal. Change over to "root" directory with Admin permissions .....	18
2)	<b>Download the required pre-requisite tools and Software into the EC2 Instance, transfer the "CBFTIG" Project files from Windows System to EC2 Instance using "FileZilla" and setup the project in the EC2 Instance</b> .....	18
a)	Download and install all the pre-required tools and software for the Hyperledger Fabric based Blockchain set-up in the created EC2 Instance.....	19
b)	In the EC2 instance, clone the "fabric-samples" directory, download and install the Hyperledger Based Blockchain Binaries Version 1.4.6 and download the Hyperledger based Docker images from Docker hub.....	19
c)	Transfer these program and files from Windows System to the created AWS EC2 Instance using the "FileZilla" software .....	19
d)	Go to "CBFTIG-network" directory and create Cryptographic based certificates and update the "docker-compose.yaml" file with the relevant CA certificate and save the file 19	
e)	Create a directory "channel-artifacts" and create genesis.block and channel.tx files under that directory and verify. Covert the "start.sh" file into an executable file .....	19
f)	Go to "CBFTIG" directory and covert the "startCBFTIG.sh" and "teardownCBFTIG.sh" files into executable ones.....	19
g)	Execute the command "npm install" and verify the creation of "node_modules" directory.....	19
<b>IX</b>	<b>Project / Solution Execution</b> .....	20
1)	In the "CBFTIG" directory, execute the command "./startCBFTIG.sh" command and verify that the Blockchain Network is up and deployed .....	20
2)	Verify that all the required docker containers are up and running.....	21
3)	Enroll the "Admin" into Blockchain Network executing the "enrollAdmin.js" file	22
4)	Register "User1" into the Blockchain Network executing the "registerUser.js" file	22



5) Query and list all the records (Bank , Customer and Forex records) that have got instantiated into the Blockchain by the Smart contract “banks.go” using “queryAll\_Data.js” file.....23

6) Query the specified Bank record and verify .....23

7) Query the specified Customer record and verify .....24

8) Query the specified Forex record and verify .....24

9) Add a new Bank record into the Blockchain then query the created record and verify it.....24

10) Add a new Customer data into the Blockchain and then query that record and verify it.....25

11) Add a new Forex rate data into the Blockchain and then query that record and verify it.....26

2) Pay the Customer US\_John\_Doe\_123 with 1000 EURO units from Customer EU\_Marcos\_999 and verify .....26

3) Query and Verify the Customers (EU\_Marcos\_999 and US\_John\_Doe\_123) data and note down their new account balances and verify.....27

4) Query the current reserves of Japanese\_Bank and UK\_Bank in the Blockchain ....28

**X) Setup and loading of “CBFTIG Frontend” ..... 29**

1) Open the “/CBFTW-front/src/App.js” file and update the Public IP address of the CBFTW Project EC2 Instance and save the file .....29

2) From the “CBFTW” directory, execute the command “node CBFTW-backend.js” and verify the display of “Listening on port 4001” .....32

3) Create a duplicate session of the EC2 Instance, navigate to “CBFTW-front” directory in that instance, execute the command “npm run start” and verify the successful starting of the React App Development Server.....32

4) Load the “CBFTW-frontend” onto the Chrome browser by using the url: “http://Public IP of the Instance:3000/” and verify the successful display of the CBFTW Application frontend .....35

**XI) Interaction with the CBFTIG Blockchain Network using CBFTW Frontend ..... 36**

1) Click on “QUERY ALL” option and then “SEARCH ALL” button. Verify the display of all the available data under “Info” window.....36

2) Query an existing Bank and verify: Click on QUERY, enter “US\_Bank” then click on “SEARCH” button .....37

3) Query an existing Customer and verify the data: Click on QUERY, enter “US\_Alice\_456” then click on “SEARCH” button .....38

4) Query an existing Forex Pair and verify the value: Click on QUERY, enter “USD:JPY” then click on “SEARCH” button .....39

5) Create a new Customer: Click on the CREATE CUSTOMER option, enter the new Customer details and then click on “CREATE CUSTOMER” button.....40

6) Query the created Customer and verify: Click on the QUERY option, enter the created Customer details and then click on “SEARCH” button .....41

7) Create a new Bank : Click on the CREATE BANK option, enter the new Bank details and then click on “CREATE BANK” button .....41



CBFTW APPLICATION

National College Jayanagar

8) Query the created Bank and verify: Click on the QUERY option, enter the created Bank details and then click on "SEARCH" button.....42

9) Create a new Forex: Click on the CREATE FOREX option, enter the new Forex details and then click on "CREATE FOREX" button.....43

10) Query the created Forex: Click on the QUERY option, enter the created Query details and then click on "SEARCH" button .....44

11) Query and verify the Customers (IND\_Ramu\_111 and EU\_Marcos\_999) data and note down their current account balances (for verifying the successful transfer of fund between them).....44

12) Query and verify the Banks (IND\_Bank and EU\_BankRamu\_111 and EU\_Bank) data and note down their current reserve amounts (for verifying the successful change in their reserves) .....45

13) Pay 1,000 units in Indian currency (INR) from the IND\_Bank Customer "IND\_Ramu\_111" to the EU\_Bank Customer "EU\_Marcos\_999" and verify .....46

14) Query and Verify the Customers (IND\_Ramu\_111 and EU\_Marcos\_999) data and note down their current account balances (for verifying the successful changes in the accounts' balances).....47

15) Query and verify the Banks (IND\_Bank and EU\_Bank) data and note down their current reserve amounts (for verifying the successful change in the Banks' reserves) ...48

XII) Closing of "CBFTIG" Project..... 49

XIII) Project Summary ..... 52

*[Handwritten Signature]*  
 PRINCIPAL  
 The National College  
 Jayanagar, Bangalore-70.







|| ಪ್ರಜ್ಞಾಪುಷ್ಪ ಪರಮಾ ಗಣಿ ||

**THE NATIONAL COLLEGE**  
Autonomous  
Jayanagar, Bangalore-560070

**Project Report on**  
**Ethereum Blockchain based**  
**eVoting for PhD Approval**

**BY**

**Bharath B**

**20NCJB404**

**Under the guidance of**

**Prof Varadaraj R**

**eVoting PhD Approval project report submitted in partial fulfilment of the**  
**requirements of**

**VI Semester BCA, THE NATIONAL COLLEGE JAYANAGAR**





|| ಶ್ರದ್ಧಾ ಪರಮಾ ರ್ಥಃ ||

**THE NATIONAL COLLEGE**  
Autonomous  
Jayanagar, Bangalore-560070

**CERTIFICATE**

This is to certify the project report titled "eVoting for PhD Approval" is a work done by **Bharath B** of **THE NATIONAL COLLEGE**, Jayanagar, Bengaluru, in partial fulfilment of the requirements of **VI Semester BCA** during the year **2022-2023**.

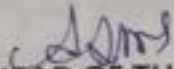
  
**HEAD OF THE DEPARTMENT**  
Head, Dept. of Comp. Science  
The National Degree College  
(Autonomous)  
Jayanagar, Bangalore - 560 070

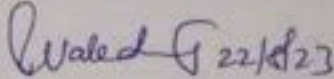
  
**PROJECT GUIDE**

Examiners:

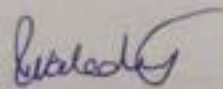
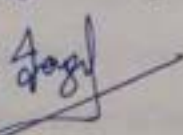
- 
- 

Examination Centre

National College, Jayanagar

Date of Examination: 22/08/23

## ACKNOWLEDGEMENT

**eVoting for PhD Approval** is the project of many hands from the team. Our tribute for the successful completion of the project goes to all those who helped through their constant guidance and encouragement. The satisfaction that accompanies the success would be incomplete without thanking person who made it.

We are thankful to our beloved Principal **Dr. B SURESHA**, who encourages us to come with new and innovative ideas and for providing the environment with all facilities for completing the project.

We are also grateful to our Head of the Department **Prof. ASHA TS** Department of computer science for her valuable guidance and constant support during our project development.

We are also grateful to our project guide **Prof. VARADARAJ R**, lecturer Department of computer science for his valuable guidance and constant support during our project development.

We are also grateful to **MUTHURAM GOVINDARASU** CEO and Founder of Indigeneous Tech Private Limited, Bangalore-32 with 10 years of experience in Blockchain for his valuable guidance and technical support for our project.

We extend our thanks to all our teaching staffs of department of computer science. Finally, we thank one and all who helped us directly and indirectly for the completion of our project.



|| ಶ್ರದ್ಧಾಢ ಪರಮಾ ಗತಿಃ ||

**THE NATIONAL COLLEGE**  
**Autonomous**  
**Jayanagar, Bangalore-560070**

**PROJECT REPORT**  
**ON**  
**HYPERLEDGER FABRIC BLOCKCHAIN BASED**  
**FABBIKE APPLICATION**

**BY**

**DARSHAN D**

  
**20NCJB407**

**Under the guidance of**

**Prof. VARADARAJ**

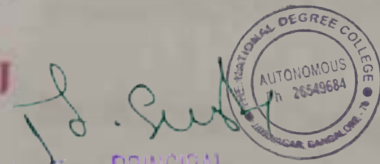

**PRINCIPAL**

**The National College**  
**Jayanagar, Bangalore-70**

**FabBike project report submitted in partial fulfillment of the requirements**  
**of**

**VI Semester BCA, THE NATIONAL COLLEGE JAYANAGAR**





## ACKNOWLEDGEMENT

FabBike Application is the project of many hands from the team. Our tribute for the successful completion of the project goes to all those who helped through their constant guidance and encouragement. The satisfaction that accompanies the success would be incomplete without thanking the person who made it.

We are thankful to our beloved Principal **Dr.B SURESHA**, who encourages us to come with new and innovative ideas and for providing the environment with all facilities for completing the project.

We are also grateful to our Head of the Department **Prof. ASHA TS** Department of Computer Science for her valuable guidance and constant support during our project development.

We are also grateful to our project guide **Prof. VARADARAJ**, lecturer Department of Computer Science for his valuable guidance and constant support during our project development.

A special thanks to **MUTHURAM GOVINDARASU**, CEO and Founder of Indigeneous Tech Private Limited, Bangalore-32 with 10 years of experience in Blockchain for his valuable guidance and technical support for our project.

We extend our thanks to all our teaching staffs of the department of Computer Science. Finally, we thank one and all who helped us directly and indirectly for the completion of our project.



**Table of Contents**

I) Project Goal (Problem Statement)	6
II) Solution Proposed	7
III) Input Data and Verification	9
IV) Project/ Solution (FabBike) Design	9
V) Tools/ Technologies Used	12
VI) Project Team Members	12
VII) Project / Solution Setup	13
1) Account and EC2 Instance creation and connection	13
a) Create an AWS free account and further create an EC2 instance with Ubuntu Operating System	13
b) Connect to the AWS EC2 Instance through "Putty" Software and open the Terminal. Change over to "root" directory with Admin permissions	13
2) Download the required pre-requisite tools and Software into the EC2 Instance, transfer the "FabBike" Project files from Windows System to EC2 Instance using "FileZilla" and setup the project in the EC2 Instance	13
a) Download and install all the pre-required tools and software for the Hyperledger Fabric based Blockchain set-up in the created EC2 Instance	13
b) In the EC2 instance, clone the "fabric-samples" directory, download and install the Hyperledger Based Blockchain Binaries Version 1.4.6 and download the Hyperledger based Docker images from Docker hub.	13
c) Transfer these program and files from Windows System to the created AWS EC2 Instance using the "FileZilla" software	13
d) Go to "fabbike-network" directory and create Cryptographic based certificates and update the "docker-compose.yaml" file with the relevant CA certificate and save the file	13
e) Create a directory "channel-artifacts" and create genesis.block and channel.tx files under that directory and verify. Covert the "start.sh" file into an executable file	13
f) Go to "fabbike" directory and covert the "startFabBike.sh" and "teardownFabBike.sh" files into executable ones	13
g) Execute the command "npm install" and verify the creation of "node_modules" directory	13
VII) Project / Solution Execution .....	14
1) In the "fabbike" directory, execute the command "./StartFabBike.sh" command and verify that the Blockchain Network is up and deployed	14
2) Execute the command "node enrollAdmin.js" and verify that the "Admin" is enrolled successfully	16
3) Execute the command "node registerUser.js" and verify that the "user1" is registered and enrolled successfully	17
4) Execute the command "node query-All-Bikes.js" and verify that the all the bike data stored inside the blockchain are read and displayed successfully	17



- 5) Execute the command “node query-BIKE4.js” and verify that the BIKE4 details are read from the blockchain and displayed successfully18
- 6) Execute the command “node invoke-BIKE10.js” and check that the BIKE10 has got stored into the blockchain successfully18
- 7) Execute the command “node query-BIKE10.js” and check that the BIKE10 data is read from the blockchain and displayed successfully19
- 8) Execute the command “node invoke-BIKE10-Owner-change.js” and check that the new owner of BIKE10 has got stored into the blockchain successfully19
- 9) Execute the command “node query-BIKE10.js” and check that the BIKE10 data is read from the blockchain and displayed successfully with new bike owner19

#### IX) Setup and loading of “FabBike Frontend”20

- 1) Open the “/fabbike-front/src/App.js” file and update the Public IP address of the fabbike EC2 Instance and save the file20
- 2) From the “fabbike” directory, execute the command “node fabbike-backend.js” and verify the display of “Listening on port 4001”23
- 3) Create the duplicate session of the EC2 Instance, navigate to “fabbike-front” directory in that instance, execute the command “npm run start” and verify the successful starting of the React App Development Server23
- 4) Load the “fabbike-frontend” onto the Chrome browser by using the url: “http://Public IP of the Instance:3000/ and verify the successful display of the fabbike frontend25

#### X) Interaction with the FabBike Blockchain Network using FabBike Frontend from Windows System Browser26

- 1) Click on “QUERY ALL” option and then “SEARCH ALL” button26
- 2) Click on QUERY, enter BIKE4 and then click on “SEARCH” button27
- 3) Click on CREATE option, enter the new Bike details and then click on “CREATE” button27
- 4) Click on QUERY option, enter BIKE11 and click on “SEARCH” button28
- 5) Click on TRANSFER option, enter BIKE11 for BIKE ID and Prakash for New Owner and then click on “TRANSFER” button29
- 6) Click on QUERY option, enter BIKE11 and click on “SEARCH” button30

#### XI) Closing of “FabBike” Project31

#### XII) Project Summary34



ಶಿಕ್ಷಣದ ಮೂಲಕ ಸಮಾಜ ಸುಖ

**THE NATIONAL COLLEGE**  
Autonomous  
Jayanagar, Bangalore-560070

**PROJECT REPORT**  
**ON**  
**HYPERLEDGER FABRIC BLOCKCHAIN BASED**  
**JOB APPOINTMENT STATUS APPLICATION**

**BY**

**MEGHANA SANDEEP**

**20NCJB413**

**Under the guidance of**

**Prof. VARADARAJ R**

**FabJob project report submitted in partial fulfillment of the requirements**  
**of**

**VI Semester BCA, THE NATIONAL COLLEGE JAYANAGAR**





|| ಶ್ರದ್ಧಾಂತಿ ಪರಮಾ ನಮಃ ||

**THE NATIONAL COLLEGE**  
**Autonomous**  
**Jayanagar, Bangalore-560070**

**CERTIFICATE**

This is to certify the project report titled "Job Appointment Status Application" is a work done by **MEGHANA SANDEEP** of THE NATIONAL COLLEGE, Jayanagar, Bengaluru, in partial fulfillment of the requirements of VI Semester BCA during the year 2022-2023.

*Adms*  
**HEAD OF THE DEPARTMENT**

Head. Dept. of Comp. Science  
The National Degree College  
(Autonomous)  
Jayanagar, Bangalore - 560 070

**Examiners:**

1. *Sant*

2.

*Wated 9/21/23*  
**PROJECT GUIDE**

**Examination Centre**

**The National College,  
Jayanagar.**

**Date of Examination:**

*To. Sant*  
**PRINCIPAL**  
**The National College**  
**Jayanagar, Bangalore-70.**



## ACKNOWLEDGEMENT

Job Appointment Status Application is the project of many hands from the team. Our tribute for the successful completion of the project goes to all those who helped through their constant guidance and encouragement. The satisfaction that accompanies the success would be incomplete without thanking the person who made it.

We are thankful to our beloved Principal **DR.B.SURESHA**, who encourages us to come with new and innovative ideas and for providing the environment with all facilities for completing the project.

We are also grateful to our Head of the Department **Prof. TS ASHA** Department of computer science for her valuable guidance and constant support during our project development.

We are also grateful to our project guide **Prof. VARADARAJ**, lecturer Department of computer science for her valuable guidance and constant support during our project development.

A special thanks to **MUTHURAM GOVINDARASU**, CEO and Founder of Indigeneous Tech Private Limited, Bangalore-32 with 10 years of experience in Blockchain for his valuable guidance and technical support for our project.

We extend our thanks to all our teaching **staffs** of the department of computer science. Finally, we thank one and all who helped us directly and indirectly for the completion of our project.



*D. Suresh*  
PRINCIPAL  
The National College  
Jayanagar, Bangalore-70



## Table of Contents

<b>I</b>	<b>Project Goal (Problem Statement)</b> .....	6
<b>II</b>	<b>Solution Proposed</b> .....	7
<b>III</b>	<b>Input Data and Verification</b> .....	8
<b>IV</b>	<b>Project/ Solution Design</b> .....	10
<b>V</b>	<b>Tools/ Technologies Used</b> .....	12
<b>VI</b>	<b>Project Team Members</b> .....	12
<b>VII</b>	<b>Referenced Documents:</b> .....	13
<b>VIII</b>	<b>Project / Solution Setup</b> .....	13
<b>1)</b>	<b>Account and EC2 Instance creation and connection</b> .....	13
<b>a)</b>	<b>Create an AWS free account and further create an EC2 instance with Ubuntu Operating System</b> .....	13
<b>b)</b>	<b>Connect to the AWS EC2 Instance through “Putty” Software and open the Terminal. Change over to “root” directory with Admin permissions</b> .....	13
<b>2)</b>	<b>Download the required pre-requisite tools and Software into the EC2 Instance, transfer the “FabJob” Project files from Windows System to EC2 Instance using “FileZilla” and setup the project in the EC2 Instance</b> .....	14
<b>a)</b>	<b>Download and install all the pre-required tools and software for the Hyperledger Fabric based Blockchain set-up in the created EC2 Instance</b> .....	14
<b>b)</b>	<b>In the EC2 instance, clone the “fabric-samples” directory, download and install the Hyperledger Based Blockchain Binaries Version 1.4.6 and download the Hyperledger based Docker images from Docker hub.</b> .....	14
<b>c)</b>	<b>Transfer these program and files from Windows System to the created AWS EC2 Instance using the “FileZilla” software</b> .....	14
<b>d)</b>	<b>Go to “FabJob-network” directory and create Cryptographic based certificates and update the “docker-compose.yaml” file with the relevant CA certificate and save the file</b> 14	
<b>e)</b>	<b>Create a directory “channel-artifacts” and create genesis.block and channel.tx files under that directory and verify. Convert the “start.sh” file into an executable file</b> .....	14
<b>f)</b>	<b>Go to “fabjob” directory and convert the “startFabJob.sh” and “teardownFabJob.sh” files into executable ones</b> .....	14
<b>g)</b>	<b>Execute the command “npm install” and verify the creation of “node_modules” directory</b> .....	14
<b>IX</b>	<b>Project / Solution Execution</b> .....	14
<b>1)</b>	<b>In the “fabjob” directory, execute the command “./StartFabJob.sh” command and verify that the Blockchain Network is up and deployed</b> .....	14
<b>2)</b>	<b>Execute the command “node enrollAdmin.js” and verify that the “Admin” is enrolled successfully</b> .....	17
<b>3)</b>	<b>Execute the command “node registerUser.js” and verify that the “user1” is registered and enrolled successfully</b> .....	18



## THE ASSIGNMENT STATES APPLICATION

4)	Execute the command "node query-All-Jobs.js" and verify that the all the job data stored inside the blockchain are read and displayed successfully .....	18
5)	Execute the command "node query-Job4.js" and verify that the JOB4 details are read from the blockchain and displayed successfully .....	19
6)	Execute the command "node invoke-JOB10.js" and check that the JOB10 has got stored into the blockchain successfully .....	19
7)	Execute the command "node query-JOB10.js" and check that the JOB10 data is read from the blockchain and displayed successfully .....	20
8)	Execute the command "node invoke-JOB10-Status-change.js" and check that the new owner of JOB10 has got stored into the blockchain successfully .....	20
9)	Execute the command "node query-JOB10.js" and check that the JOB10 data is read from the blockchain and displayed successfully with new Job owner .....	20
<b>XI</b>	<b>Setup and loading of "FabJob Frontend" .....</b>	<b>21</b>
1)	Open the "%fabjob-front/src/App.js" file and update the Public IP address of the FabJob EC2 Instance and save the file .....	21
2)	From the "fabjob" directory, execute the command "node fabjob-backend.js" and verify the display of "Listening on port 4001" .....	24
3)	Create the duplicate session of the EC2 Instance, navigate to "fabjob-front" directory in that instance, execute the command "npm run start" and verify the successful starting of the React App Development Server .....	25
4)	Load the "fabjob-frontend" onto the Chrome browser by using the url: "http://Public IP of the Instance:3000/" and verify the successful display of the fabjob frontend .....	26
<b>XII</b>	<b>Interaction with the FabJob Blockchain Network using FabJob Frontend from Windows System Browser .....</b>	<b>28</b>
1)	Click on "QUERY ALL" option and then "SEARCH ALL" button .....	28
2)	Click on QUERY, enter JOB4 and then click on "SEARCH" button .....	28
3)	Click on CREATE option, enter the new Job details and then click on "CREATE" button .....	Error! Bookmark not defined.
4)	Click on QUERY option, enter JOB11 and click on "SEARCH" button .....	29
5)	Click on TRANSFER option, enter JOB11 for JOB ID and Prakash for New Owner and then click on "TRANSFER" button .....	30
6)	Click on QUERY option, enter JOB11 and click on "SEARCH" button .....	30
<b>XIII</b>	<b>Closing of "FabJob" Project .....</b>	<b>31</b>
<b>XIII)</b>	<b>Project Summary .....</b>	<b>35</b>



**Project Goal (Problem Statement)**

To design, develop, implement and verify the Hyperledger Fabric based block chain application having the following features:

- 1) Query from the Job' data that is available as part of the Blockchain (Reading bulk data from the Blockchain)
- 2) Query any one of the Job' data that is available as part of the Blockchain (Reading individual record or data from the Blockchain)
- 3) Add a new Job data and verify that it gets added successfully into the Blockchain (Writing a new record into the blockchain and its verification)
- 4) Change the Status of existing Job data and verify (Changing [means creating new record as no modification of existing record is allowed in Blockchain] the existing data in the blockchain and its verification)
- 5) Modify the Status of the existing Job data and verify (Modifying the existing data in the blockchain and its verification). Here, also a new record is created with new owner Name and the existing record is not getting modified which is one of the main feature of Blockchain technology

**Note:** These verifications need to be done both in Command Line Interface (CLI) mode and also using browser based front-end mode.

## Solution Proposed

- 1) We will design, develop, implement and verify the Hyperledger Fabric based Blockchain network namely "Job Appointment Status Application" in an Ubuntu O/S based EC2 Instance in AWS.
- 2) We will write the required Blockchain configuration and other files so as to bring-up the Blockchain network
- 3) We will write a Golang program namely "fabjob.go" in which we will implement the main logic of the Solution.
- 4) In the fabjob.go program, we will design the Job data with the Name,Status,Sex,Designation etc..

```

$ go run main.go
INFO [02/02/2023 10:10:10 AM] Successfully loaded user data from database
INFO [02/02/2023 10:10:10 AM] User data loaded successfully
INFO [02/02/2023 10:10:10 AM] User data loaded successfully
INFO [02/02/2023 10:10:10 AM] User data loaded successfully
INFO [02/02/2023 10:10:10 AM] User data loaded successfully
INFO [02/02/2023 10:10:10 AM] User data loaded successfully
INFO [02/02/2023 10:10:10 AM] User data loaded successfully
INFO [02/02/2023 10:10:10 AM] User data loaded successfully
INFO [02/02/2023 10:10:10 AM] User data loaded successfully
INFO [02/02/2023 10:10:10 AM] User data loaded successfully

```

- 5) The program will have 10 Job data which will initialize the Blockchain on the starting of the Blockchain

```

$ go run main.go
INFO [02/02/2023 10:10:10 AM] Successfully loaded user data from database
INFO [02/02/2023 10:10:10 AM] User data loaded successfully
INFO [02/02/2023 10:10:10 AM] User data loaded successfully
INFO [02/02/2023 10:10:10 AM] User data loaded successfully
INFO [02/02/2023 10:10:10 AM] User data loaded successfully
INFO [02/02/2023 10:10:10 AM] User data loaded successfully
INFO [02/02/2023 10:10:10 AM] User data loaded successfully
INFO [02/02/2023 10:10:10 AM] User data loaded successfully
INFO [02/02/2023 10:10:10 AM] User data loaded successfully
INFO [02/02/2023 10:10:10 AM] User data loaded successfully

```

- 6) In the program, we will create the functions queryJob, initLedger, createJob, queryAllJobs and changeJobStatus to meet the Solution requirements.



```
172-31-42-255:~/fabric-samples/FabJob# node change-JOB4-Status-Appointed.js
path:/root/fabric-samples/FabJob/hfc-key-store
fully loaded user1 from persistence
ing transaction id: b24f090724a8d06569b4a028c44418511cba4303c1220bf37ca5eae90cd7786
tion proposal was good
fully sent Proposal and received ProposalResponse: Status - 200, message - ""
transaction has been committed on peer localhost:7051
transaction promise and event listener promise have completed
fully sent transaction to the orderer.
fully committed the change to the ledger by the peer
172-31-42-255:~/fabric-samples/FabJob# █
```

- Also, we will create relevant JavaScript files to interact with the established Blockchain network in CLI mode, so as to meet the solution requirements.
- 1) We will create the required Shell script files so as to automate the starting and closing of the Blockchain network.
  - 2) We will also create a frontend (React App based) for the solution so that you can interact with the Blockchain network from your Windows system.



ಶಿಕ್ಷಣದ ಮೂಲಕ ಸಮಾಜ ಸುಧಾರಣೆ

**THE NATIONAL COLLEGE**  
Autonomous  
Jayanagar, Bangalore-560070

**PROJECT REPORT**  
**ON**  
**HYPERLEDGER FABRIC BLOCKCHAIN BASED**  
**JOB APPOINTMENT STATUS APPLICATION**  
**BY**

**NAYAN KUMAR YN**

**20NCJIB415**

Under the guidance of

**Prof. VARADARAJ R**



*D. Sudh*  
PRINCIPAL  
The National College  
Jayanagar, Bangalore-70.

**FabJob project report submitted in partial fulfillment of the requirements**  
**of**

**VI Semester BCA, THE NATIONAL COLLEGE JAYANAGAR**





|| ಶ್ರೀಮತು ವಿದ್ಯಾಪೀಠಃ ||

**THE NATIONAL COLLEGE**  
**Autonomous**  
**Jayanagar, Bangalore-560070**

**CERTIFICATE**

This is to certify the project report titled "Job Appointment Status Application" is a work done by **NAYAN KUMAR YN** of THE NATIONAL COLLEGE, Jayanagar, Bengaluru, in partial fulfilment of the requirements of VI Semester BCA during the year 2022-2023.

  
**HEAD OF THE DEPARTMENT**  
Head, Dept. of Computer Science  
The National Degree College  
(Autonomous)  
Jayanagar, Bangalore - 560 070

  
**PROJECT GUIDE**

**Examiners:**

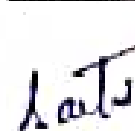
1. 

2.

**Examination Centre**

**The National College,  
Jayanagar.**

**Date of Examination:**



  
**PRINCIPAL**  
The National College  
Jayanagar, Bangalore-70.

## **ACKNOWLEDGEMENT**

Job Appointment Status Application is the project of many hands from the team. Our tribute for the successful completion of the project goes to all those who helped through their constant guidance and encouragement. The satisfaction that accompanies the success would be incomplete without thanking the person who made it.

We are thankful to our beloved Principal DR.B.SURESHA, who encourages us to come with new and innovative ideas and for providing the environment with all facilities for completing the project.

We are also grateful to our Head of the Department Prof. TS ASHA Department of computer science for her valuable guidance and constant support during our project development.

We are also grateful to our project guide Prof. VARADARAJ, lecturer Department of computer science for her valuable guidance and constant support during our project development.

A special thanks to **MUTHURAM GOVINDARASU**, CEO and Founder of Indigeneous Tech Private Limited, Bangalore-32 with 10 years of experience in Blockchain for his valuable guidance and technical support for our project.

We extend our thanks to all our teaching staffs of the department of computer science. Finally, we thank one and all who helped us directly and indirectly for the completion of our project.



## Table of Contents

<b>I</b>	<b>Project Goal (Problem Statement)</b> .....	6
<b>II</b>	<b>Solution Proposed</b> .....	7
<b>III</b>	<b>Input Data and Verification</b> .....	8
<b>IV</b>	<b>Project/ Solution Design</b> .....	10
<b>V</b>	<b>Tools/ Technologies Used</b> .....	12
<b>VI</b>	<b>Project Team Members</b> .....	12
<b>VII</b>	<b>Referenced Documents</b> .....	13
<b>VIII</b>	<b>Project / Solution Setup</b> .....	13
1)	<b>Account and EC2 Instance creation and connection</b> .....	13
a)	<b>Create an AWS free account and further create an EC2 instance with Ubuntu Operating System</b> .....	13
b)	<b>Connect to the AWS EC2 Instance through "Putty" Software and open the Terminal. Change over to "root" directory with Admin permissions</b> .....	13
2)	<b>Download the required pre-requisite tools and Software into the EC2 Instance, transfer the "FabJob" Project files from Windows System to EC2 Instance using "FileZilla" and setup the project in the EC2 Instance</b> .....	14
a)	<b>Download and install all the pre-required tools and software for the Hyperledger Fabric based Blockchain set-up in the created EC2 Instance</b> .....	14
b)	<b>In the EC2 instance, clone the "fabric-samples" directory, download and install the Hyperledger Based Blockchain Binaries Version 1.4.6 and download the Hyperledger based Docker images from Docker hub.</b> .....	14
c)	<b>Transfer these program and files from Windows System to the created AWS EC2 Instance using the "FileZilla" software</b> .....	14
d)	<b>Go to "FabJob-network" directory and create Cryptographic based certificates and update the "docker-compose.yaml" file with the relevant CA certificate and save the file</b> 14	
e)	<b>Create a directory "channel-artifacts" and create genesis.block and channel.tx files under that directory and verify. Covert the "start.sh" file into an executable file</b> .....	14
f)	<b>Go to "fabjob" directory and covert the "startFabJob.sh" and "teardownFabJob.sh" files into executable ones</b> .....	14
g)	<b>Execute the command "npm install" and verify the creation of "node_modules" directory</b> .....	14
<b>IX</b>	<b>Project / Solution Execution</b> .....	14
1)	<b>In the "fabjob" directory, execute the command "_StartFabJob.sh" command and verify that the Blockchain Network is up and deployed</b> .....	14
2)	<b>Execute the command "node enrollAdmin.js" and verify that the "Admin" is enrolled successfully</b> .....	17
3)	<b>Execute the command "node registerUser.js" and verify that the "user1" is registered and enrolled successfully</b> .....	18

4) Execute the command "node query-All-Jobs.js" and verify that the all the job data stored inside the blockchain are read and displayed successfully .....	18
5) Execute the command "node query-Job4.js" and verify that the JOB4 details are read from the blockchain and displayed successfully .....	19
6) Execute the command "node invoke-JOB10.js" and check that the JOB10 has got stored into the blockchain successfully .....	19
7) Execute the command "node query-JOB10.js" and check that the JOB10 data is read from the blockchain and displayed successfully .....	20
8) Execute the command "node invoke-JOB10-Status-change.js" and check that the new owner of JOB10 has got stored into the blockchain successfully .....	20
9) Execute the command "node query-JOB10.js" and check that the JOB10 data is read from the blockchain and displayed successfully with new Job owner .....	20
<b>X) Setup and loading of "FabJob Frontend" .....</b>	<b>21</b>
1) Open the "/fabjob-front/src/App.js" file and update the Public IP address of the FabJob EC2 Instance and save the file .....	21
2) From the "fabjob" directory, execute the command "node fabjob-backend.js" and verify the display of "Listening on port 4001" .....	24
3) Create the duplicate session of the EC2 Instance, navigate to "fabjob-front" directory in that instance, execute the command "npm run start" and verify the successful starting of the React App Development Server .....	25
4) Load the "fabjob-frontend" onto the Chrome browser by using the url: "http://Public IP of the Instance:3000/" and verify the successful display of the fabjob frontend .....	26
<b>XI) Interaction with the FabJob Blockchain Network using FabJob Frontend from Windows System Browser .....</b>	<b>28</b>
1) Click on "QUERY ALL" option and then "SEARCH ALL" button .....	28
2) Click on QUERY, enter JOB4 and then click on "SEARCH" button .....	28
3) Click on CREATE option, enter the new Job details and then click on "CREATE" button .....	Error! Bookmark not defined.
4) Click on QUERY option, enter JOB11 and click on "SEARCH" button .....	29
5) Click on TRANSFER option, enter JOB11 for JOB ID and Prakash for New Owner and then click on "TRANSFER" button .....	30
6) Click on QUERY option, enter JOB11 and click on "SEARCH" button .....	30
<b>XII) Closing of "FabJob" Project .....</b>	<b>31</b>
<b>XIII) Project Summary .....</b>	<b>35</b>



## **I) Project Goal (Problem Statement)**

To design, develop, implement and verify the Hyperledger Fabric based Block chain application having the following features:

- 1) Query from the Job' data that is available as part of the Blockchain (Reading bulk data from the Blockchain)
- 2) Query any one of the Job' data that is available as part of the Blockchain (Reading individual record or data from the Blockchain)
- 3) Add a new Job data and verify that it gets added successfully into the Blockchain (Writing a new record into the blockchain and its verification)
- 4) Change the Status of existing Job data and verify (Changing [means creating new record as no modification of existing record is allowed in Blockchain] the existing data in the blockchain and its verification)
- 5) Modify the Status of the existing Job data and verify (Modifying the existing data in the blockchain and its verification). Here, also a new record is created with new owner Name and the existing record is not getting modified which is one of the main feature of Blockchain technology

**Note:** These verifications need to be done both in Command Line Interface (CLI) mode and also using browser based front-end mode.





```
root@ip-172-31-42-255:~/fabric-samples/FabJob# node -change-job-status-Appointed.js
state path:/root/fabric-samples/FabJob/hfc-key-store
successfully loaded user1 from persistence
Assigning transaction id: b24f090724a8306569b4a020c44418511c8a4303c1220bf37ca5a4b90cf7704
Transaction proposal was good
successfully sent Proposal and received ProposalResponse: status - 200, message - **
the transaction has been committed on peer localhost:7051
send transaction promise and event listener promise have completed
successfully sent transaction to the orderer.
successfully committed the change to the ledger by the peer
root@ip-172-31-42-255:~/fabric-samples/FabJob#
```

- 7) Also, we will create relevant JavaScript files to interact with the established Blockchain network in CLI mode, so as to meet the solution requirements.
- 8) We will create the required Shell script files so as to automate the starting and closing of the Blockchain network.
- 9) We will also create a frontend (React App based) for the solution so that you can interact with the Blockchain network from your Windows system.

### III) Input Data and Verification

Sl.No.	Car ID	Make	Model	Colour	Owner	Remarks	Program Used
Initial 10 Cars' records to be updated in "fabcar.go" program							
1	CAR0	Toyota	Prius	blue	Tomoko	These 10 Cars' records data will get stored in a block of the Blockchain on starting of the Blockchain	fabcar.go
2	CAR1	Ford	Mustang	red	Brad		
3	CAR2	Hyundai	Tucson	green	Jin Soo		
4	CAR3	Volkswagen	Passat	yellow	Max		
5	CAR4	Tesla	S	black	Adriana		
6	CAR5	Peugeot	205	purple	Michel		
7	CAR6	Chery	S22L	white	Aarav		
8	CAR7	Fiat	Punto	violet	Pari		
9	CAR8	Tata	Nano	indigo	Valeria		
10	CAR9	Holden	Barina	brown	Shotaro		
Query and display all the 10 records stored in the block of the Blockchain in CLI Mode						Read and display of stored bulk records from Blockchain	query-All-Cars.js
Query the Car Record, having Car ID as CAR4 and display it in CLI Mode						Read and display of a single Car record (CAR4) from Blockchain	query-CAR4.js
Creation of New Car Record in the Blockchain using JavaScript File in CLI Mode						Creation of new Car (CAR10) record in a block of the Blockchain	invoke-CAR10.js
11	CAR10	Honda	Accord	Black	Tom	Read and verify the successful creation of the New Car (CAR10) record	query-CAR10.js
Verification of the created New Record in the Blockchain using JavaScript File in CLI Mode							
11	CAR10	Honda	Accord	Black	Tom	Modify the existing blockchain record (Here, the existing record is immutable). So, a new record will be created in the Blockchain reflecting the change	invoke-CAR10-Owner-change.js
Change of Owner of the Car (CAR10) using JavaScript File in CLI Mode							
11	CAR10	Honda	Accord	Black	Nike		
Query and verification of (CAR10) data with changed Owner name using JavaScript File in CLI Mode							
11	CAR10	Honda	Accord	Black	Nike	Creation of new Car (CAR11) record in a block of the Blockchain	Using frontend
Creation and verification of New Car (CAR11) record using Frontend							
12	CAR11	Mahindra	XUV500	Silver	Ramu	Read and verify the successful creation of the New Car (CAR11) record	Using frontend
Change and verification of changed Owner of Car (CAR11) using Frontend							
12	CAR11	Mahindra	XUV500	Silver	Prakash		



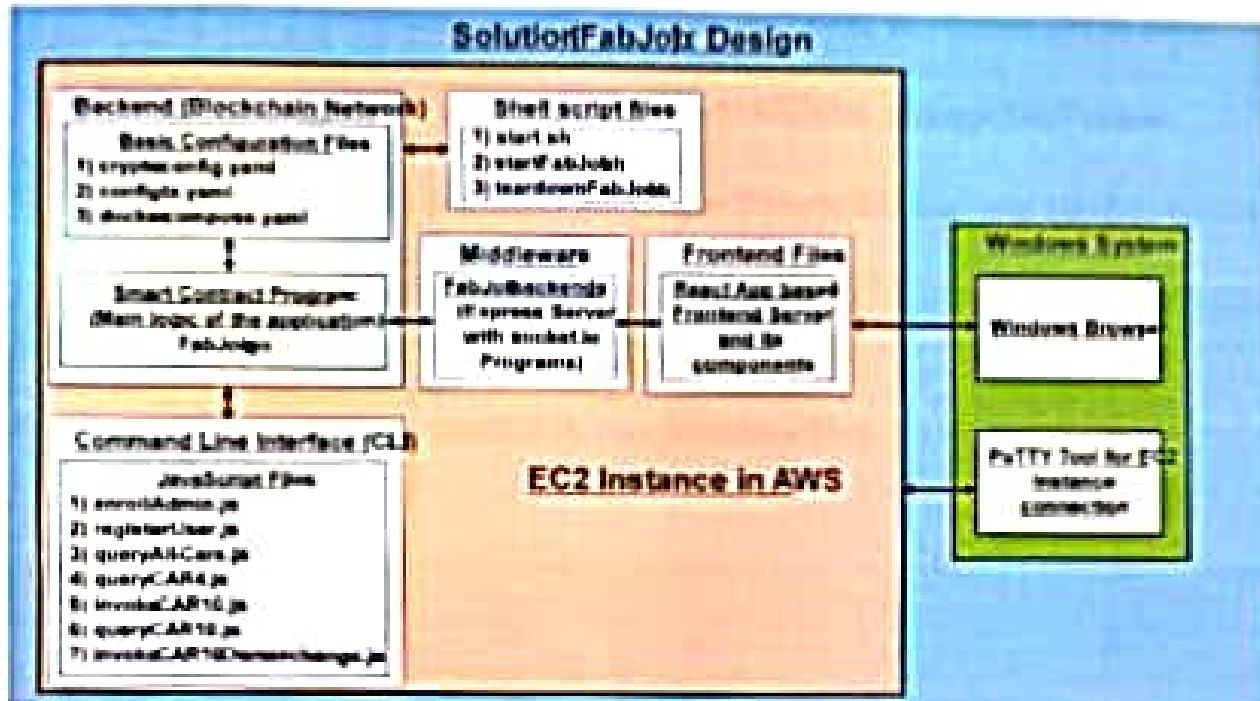

### High Level:

- 1) Create the following in the EC2 Instance of an AWS Account:
  - a) Golang program with required data and functions
  - b) FabJob Blockchain basic configuration files
  - c) Required Shell Script files
  - d) CLI based JavaScript files in the EC2 Instance
  - e) Middleware JavaScript file for the frontend interaction
  - f) React App based frontend files
- 2) Download and install the following in your Windows System:
  - a) PuTTY.exe along with PuTTYgen
  - b) Filezilla software tool

### Details:

- 1) Write a goLang program namely "fabJob.go" with the below given info:
  - a) Job Data Structure (make, model, colour, owner)
  - b) Functions (queryJob, createJob, queryAllJobs, changeJobStatus)
  - c) Data for 10 Jobs
- 2) Write the below given basic Hyperledger Fabric Blockchain configuration files
  - a) crypto-config.html
  - b) configtx.html
  - c) docker-compose.html
- 3) Write the below given JavaScript application files
  - a) enrollAdmin.js
  - b) registerUser.js
  - c) query-All-Jobs.js
  - d) query-Job4.js
  - e) invoke-Job10.js
  - f) query-Job10.js
  - g) invoke-Job10-Status-change.js
- 4) Write the below given Shell script files
  - a) start.sh
  - b) startFabJob.sh
  - c) teardownFabJob.sh
- 5) Write the middleware JavaScript file namely "fabjob-backend.js"
- 6) Create the required React App based frontend files

**Note: Organise these files as given in the below given directory structure. We need to transfer this folder to the EC2 Instance using "Filezilla" tool**





#### V) Tools/ Technologies Used

- AWS EC2 Instance: AWS EC2 Instance with O/S Ubuntu AMI
- Nodejs and NPM
- Golang
- Docker Container and Docker Compose
- Hyperledger Fabric based Blockchain Binaries Version 1.4.6
- Hyperledger based Docker Images
- JavaScript
- Shellscript
- React App

#### VI) Project Team Member

- 1) Nayan Kumar Y N

**VI) Referenced Documents:**

- 1) **Appendix-A: 02-AWS-Free-Account-and-Instance-Creation-Steps-25-Aug-2022.docx**
- 2) **Appendix-B: 03-Setup-Hyperledger-Fabric-based-Blockchain-Network-and-Setup-Environment-for-FabJob-Project-25-Aug-2022.docx**
- 3) **Appendix-C: 04-List-of-Programs-and-Files-Used-in-FabJob-Project-25-Aug-2022.docx**

**VII) Project / Solution Setup**

- 1) **Account and EC2 Instance creation and connection**
  - a) **Create an AWS free account and further create an EC2 instance with Ubuntu Operating System**
  - b) **Connect to the AWS EC2 Instance through "Putty" Software and open the Terminal. Change over to "root" directory with Admin permissions**

**(For the above given Steps-1 and 2, please refer the Document at "Appendix-A" to this report)**



- 2) Download the required pre-requisite tools and Software into the EC2 Instance, transfer the "FabJob" Project files from Windows System to EC2 Instance using "FileZilla" and setup the project in the EC2 Instance
- Download and install all the pre-required tools and software for the Hyperledger Fabric based Blockchain set-up in the created EC2 Instance
  - In the EC2 Instance, clone the "fabric-samples" directory, download and install the Hyperledger Based Blockchain Binaries Version 1.4.6 and download the Hyperledger based Docker images from Docker hub.
  - Transfer these program and files from Windows System to the created AWS EC2 Instance using the "FileZilla" software
  - Go to "FabJob-network" directory and create Cryptographic based certificates and update the "docker-compose.yaml" file with the relevant CA certificate and save the file
  - Create a directory "channel-artifacts" and create genesis.block and channel.tx files under that directory and verify. Convert the "start.sh" file into an executable file
  - Go to "FabJob" directory and convert the "startFabJob.sh" and "teardownFabJob.sh" files into executable ones
  - Execute the command "npm install" and verify the creation of "node\_modules" directory

(For the above given Steps-a to g, please refer the Document at "Appendix-B" to this report)

(For referring to the Programs used in this project, please refer the Document at "Appendix-C" to this report)

### **NIProject / Solution Execution**

- In the "FabJob" directory, execute the command "./StartFabJob.sh" command and verify that the Blockchain Network is up and deployed



॥ ಪ್ರದ್ಯುಮ್ನ ಪರಮಾ ಗಣಿ: ॥

**THE NATIONAL COLLEGE**  
Autonomous  
Jayanagar, Bangalore-560070

**Project Report on**  
**Ethereum Blockchain based**  
**eVoting for Election Application**

*T.D. Sushy*  
PRINCIPAL  
The National College  
Jayanagar, Bangalore-70

**BY**

**NITHISH B**

**20NCJB416**



**Under the guidance of**

**VARADARAJ R**

eVoting for Road-Tenders project report submitted in partial fulfilment of the  
requirements of

**VI Semester BCA, THE NATIONAL COLLEGE JAYANAGAR**





ಶ್ರೀ ಶ್ರೀಶೈಲ ಶರಣಾ ನರಃ

**THE NATIONAL COLLEGE**  
Autonomous  
Jayanagar, Bangalore-560070

### CERTIFICATE

This is to certify the project report titled "eVoting for Road-Tenders Approval" is a work done by **NITHISH B(20NCJB416)** of **THE NATIONAL COLLEGE**, Jayanagar, Bengaluru, in partial fulfilment of the requirements of **VI Semester BCA** during the year **2022-2023**.

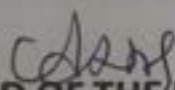
  
**HEAD OF THE DEPARTMENT**  
Head. Dept. of Comp. Science  
The National Degree College  
(Autonomous)  
Jayanagar, Bangalore - 560 070

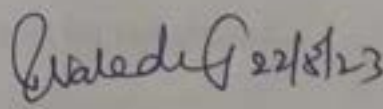
  
**PROJECT GUIDE**

Examiners:

Examination Centre

1.

National College, Jayanagar

2.

Date of Examination:

## ACKNOWLEDGEMENT

**eVoting for Road-Tenders** is the project of many hands from the team. Our tribute for the successful completion of the project goes to all those who helped through their constant guidance and encouragement. The satisfaction that accompanies the success would be incomplete without thanking person who made it.

We are thankful to our beloved Principal **Dr B Suresha**, who encourages us to come with new and innovative ideas and for providing the environment with all facilities for completing the project.

We are also grateful to our Head of the Department **Prof. Asha T S** and project guide **Prof Varadaraj**, lecturer Department of computer science for her valuable guidance and constant support during our project development.

We are also grateful to **Muthuram Govindarasu** CEO and Founder of Indigeneous Tech Private Limited, Bangalore-32 with 10 years of experience in Blockchain for his valuable guidance and technical support for our project.

We extend our thanks to all our teaching staffs of department of computer science. Finally, we thank one and all who helped us directly and indirectly for the completion of our project.



## Table of Contents

I) Project Goal (Problem Statement) .....	6
II) Solution Proposed .....	6
III) Input Data .....	6
IV) Project Team Members .....	6
Referenced Documents .....	6
V) Project/ Solution (eVoting for Election Application) Design .....	7
VI) Tools/ Technologies Used .....	8
VII) Install the Tools required for the Ethereum Based Blockchain Project in Windows System .....	8
VIII) Setup the Ethereum Blockchain based Project "eVoting for Election Application" in the Windows System .....	8
IX) Project Execution .....	9
1) Start the Desktop version of Ganache (Test Ethereum Blockchain) .....	9
2) Sign-in to the Metamask, select the network "Ganache Desktop Network7545", import the first account of the Ganache Blockchain and make sure that the account is in "connected" state. Rename the account as "Admin-Acct" .....	10
3) Compile and deploy the smart contract on to Ethereum Test Blockchain on to Ganache using Ether through Metamask. Further deploy the frontend onto your default Browser. 12	
4) Click on "ADMIN" option and fill-in the relevant info under "About Admin", "About eVoting" and click on "Start eVoting" button. Click on the "Confirm" button of the Metamask. Verify that the eVoting process got started .....	14
5) Click on "Add Tender" option and fill-in the info related to the Tenders for which you need eVoting. Create 2 Candidates for eVoting .....	16
6) Click on "Registration" and register 3 Voters .....	19
7) Select the "Admin-Account" in Metamask, refresh the screen, click on "Verification" link and as an Admin approve all the 3 Voters .....	23
8) Click on "Voting" link and check the Tender Info displayed .....	26
9) Select the "Vote1-Acct" in Metamask, make sure that the account is in "connected" status, refresh the screen, confirm that "Vote" buttons are enabled now, click on "Vote" button against the Tender titled " ORR Tender-1" .....	27
10) Select the "Vote2-Acct" in Metamask, make sure that the account is in "connected" status, refresh the screen, confirm that "Vote" buttons are enabled now, click on "Vote" button against the Tender "ORR Tender-2" .....	29
11) Select the "Vote3-Acct" in Metamask, make sure that the account is in "connected" status, refresh the screen, confirm that "Vote" buttons are enabled now, click on "Vote" button against the Tender "ORR Tender-1" .....	30
12) Select "Admi-Acct", make sure that the account is in "connected" status, refresh the page, click on "ADMIN" and click on "eVoting End" button as an Admin .....	31

13) Click on "Results" link and verify the eVoting Results .....	32
X) Project Summary .....	32





॥ ಶ್ರದ್ಧಾ಼ ಪರಮಾ ಗ಼ಃ ॥

**THE NATIONAL COLLEGE**  
**Autonomous**  
**Jayanagar, Bangalore-560070**

**PROJECT REPORT**  
**ON**  
**HYPERLEDGER FABRIC BLOCKCHAIN BASED**  
**FABBIKE APPLICATION**

**BY**

**PAVAN KUMAR S**

**20NCJB418**

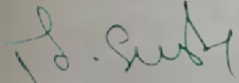
  
PRINCIPAL  
The National College  
Jayanagar, Bangalore-70

**Under the guidance of**

**Prof. VARADARAJ**



**FabBike project report submitted in partial fulfillment of the requirements**  
**of**

**VI Semester BCA, THE NATIONAL COLLEGE JAYANAGAR**



|| ಪ್ರದ್ಯಾಹಿ ಪರಮಾ ಗತಿ: ||

**THE NATIONAL COLLEGE**  
**Autonomous**  
**Jayanagar, Bangalore-560070**

**CERTIFICATE**

This is to certify the project report titled "FabBike Application" is a work done by **PAVAN KUMAR S** of THE NATIONAL COLLEGE, Jayanagar, Bengaluru, in partial fulfillment of the requirements of VI Semester BCA during the year 2023.

  
**HEAD OF THE DEPARTMENT**  
Head, Dept. of Comp. Science  
The National Degree College  
(Autonomous)  
Jayanagar, Bangalore - 560 070

**Examiners:**

1.

2.

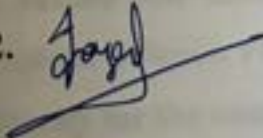

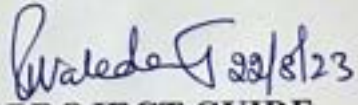
  
**PROJECT GUIDE**

**Examination Centre**

**The National College,  
Jayanagar.**

**Date of Examination:**



## ACKNOWLEDGEMENT

FabBike Application is the project of many hands from the team. Our tribute for the successful completion of the project goes to all those who helped through their constant guidance and encouragement. The satisfaction that accompanies the success would be incomplete without thanking the person who made it.

We are thankful to our beloved Principal **Dr.B SURESHA**, who encourages us to come with new and innovative ideas and for providing the environment with all facilities for completing the project.

We are also grateful to our Head of the Department **Prof. ASHA TS** Department of Computer Science for her valuable guidance and constant support during our project development.

We are also grateful to our project guide **Prof. VARADARAJ**, lecturer Department of Computer Science for his valuable guidance and constant support during our project development.

A special thanks to **MUTHURAM GOVINDARASU**, CEO and Founder of Indigeneous Tech Private Limited, Bangalore-32 with 10 years of experience in Blockchain for his valuable guidance and technical support for our project.

We extend our thanks to all our teaching staffs of the department of Computer Science. Finally, we thank one and all who helped us directly and indirectly for the completion of our project.

**Table of Contents**

I) Project Goal (Problem Statement)	6
II) Solution Proposed	7
III) Input Data and Verification	9
IV) Project/ Solution (FabBike) Design	9
V) Tools/ Technologies Used	12
VI) Project Team Members	12
VII) Project / Solution Setup	13
1) Account and EC2 Instance creation and connection	13
a) Create an AWS free account and further create an EC2 instance with Ubuntu Operating System	13
b) Connect to the AWS EC2 Instance through "Putty" Software and open the Terminal. Change over to "root" directory with Admin permissions	13
2) Download the required pre-requisite tools and Software into the EC2 Instance, transfer the "FabBike" Project files from Windows System to EC2 Instance using "FileZilla" and setup the project in the EC2 Instance	13
a) Download and install all the pre-required tools and software for the Hyperledger Fabric based Blockchain set-up in the created EC2 Instance	13
b) In the EC2 instance, clone the "fabric-samples" directory, download and install the Hyperledger Based Blockchain Binaries Version 1.4.6 and download the Hyperledger based Docker images from Docker hub.	13
c) Transfer these program and files from Windows System to the created AWS EC2 Instance using the "FileZilla" software	13
d) Go to "fabbike-network" directory and create Cryptographic based certificates and update the "docker-compose.yaml" file with the relevant CA certificate and save the file	13
e) Create a directory "channel-artifacts" and create genesis.block and channel.tx files under that directory and verify. Covert the "start.sh" file into an executable file	13
f) Go to "fabbike" directory and covert the "startFabBike.sh" and "teardownFabBike.sh" files into executable ones	13
g) Execute the command "npm install" and verify the creation of "node_modules" directory	13
VII) Project / Solution Execution .....	14
1) In the "fabbike" directory, execute the command "./StartFabBike.sh" command and verify that the Blockchain Network is up and deployed	14
2) Execute the command "node enrollAdmin.js" and verify that the "Admin" is enrolled successfully	16
3) Execute the command "node registerUser.js" and verify that the "user1" is registered and enrolled successfully	17
4) Execute the command "node query-All-Bikes.js" and verify that the all the bike data stored inside the blockchain are read and displayed successfully	17



- 5) Execute the command "node query-BIKE4.js" and verify that the BIKE4 details are read from the blockchain and displayed successfully18
- 6) Execute the command "node invoke-BIKE10.js" and check that the BIKE10 has got stored into the blockchain successfully18
- 7) Execute the command "node query-BIKE10.js" and check that the BIKE10 data is read from the blockchain and displayed successfully19
- 8) Execute the command "node invoke-BIKE10-Owner-change.js" and check that the new owner of BIKE10 has got stored into the blockchain successfully19
- 9) Execute the command "node query-BIKE10.js" and check that the BIKE10 data is read from the blockchain and displayed successfully with new bike owner19

#### IX) Setup and loading of "FabBike Frontend"20

- 1) Open the "/fabbike-front/src/App.js" file and update the Public IP address of the fabbike EC2 Instance and save the file20
- 2) From the "fabbike" directory, execute the command "node fabbike-backend.js" and verify the display of "Listening on port 4001"23
- 3) Create the duplicate session of the EC2 Instance, navigate to "fabbike-front" directory in that instance, execute the command "npm run start" and verify the successful starting of the React App Development Server23
- 4) Load the "fabbike-frontend" onto the Chrome browser by using the url: "http://Public IP of the Instance:3000/" and verify the successful display of the fabbike frontend25

#### X) Interaction with the FabBike Blockchain Network using FabBike Frontend from Windows System Browser26

- 1) Click on "QUERY ALL" option and then "SEARCH ALL" button26
- 2) Click on QUERY, enter BIKE4 and then click on "SEARCH" button27
- 3) Click on CREATE option, enter the new Bike details and then click on "CREATE" button27
- 4) Click on QUERY option, enter BIKE11 and click on "SEARCH" button28
- 5) Click on TRANSFER option, enter BIKE11 for BIKE ID and Prakash for New Owner and then click on "TRANSFER" button29
- 6) Click on QUERY option, enter BIKE11 and click on "SEARCH" button30

#### XI) Closing of "FabBike" Project31

#### XII) Project Summary34



॥ ಶ್ರದ್ಧಾಢ ಪರಮಾ ಗತಿಃ ॥

**THE NATIONAL COLLEGE**  
**Autonomous**  
**Jayanagar, Bangalore-560070**

**PROJECT REPORT**  
**ON**  
**ETHEREUM BLOCKCHAIN BASED TELEVISION**  
**PURCHASE SHOP APPLICATION**

**BY**

**POOJA E ACHARI**

**20NCJB419**

  
**PRINCIPAL**  
**The National College**  
**Jayanagar, Bangalore-70**

**Under the guidance of**

**Prof. VARADARAJ.R**



**Television Purchase Shop Project report submitted in partial**  
**fulfilment of the requirements of**  
**VI Semester BCA, National College, Jayanagar, Bangalore**





॥ ಶ್ರದ್ಧಾಹಿ ಪರಮಾ ಗತಿಃ ॥

**THE NATIONAL COLLEGE**  
**Autonomous**  
**Jayanagar, Bangalore-560070**

**CERTIFICATE**

This is to certify the project report titled  
"Television Purchase Shop Application" is a work done by  
**POOJA E ACHARI**  
of THE NATIONAL COLLEGE, Jayanagar, Bengaluru, in partial  
fulfilment of the requirements of VI Semester BCA during the year  
2022-2023.

  
**HEAD OF THE DEPARTMENT**

Head. Dept. of Comp. Science  
The National Degree College  
(Autonomous)  
Jayanagar, Bangalore - 560 070

**Examiners:**

1.

2.



  
**PROJECT GUIDE**

**Examination Centre**

**The National College, Jayanagar**

**Date of Examination:**

## ACKNOWLEDGEMENT

Television Purchase Shop Application is the project of many hands from the team. Our tribute for the successful completion of the project goes to all those who helped through their constant guidance and encouragement. The satisfaction that accompanies the success would be incomplete without thanking the person who made it.

We are thankful to our beloved Principal **Dr.B.SURESHA**, who encourages us to come with new and innovative ideas and for providing the environment with all facilities for completing the project.

We are also grateful to our Head of the Department **Prof. ASHA T S** Department of computer science for her valuable guidance and constant support during our project development.

We are also grateful to our project guide **Prof. VARADARAJ.R**, lecturer Department of computer science for his valuable guidance and constant support during our project development.

A special thanks to **MUTHURAM GOVINDARASU**, CEO and Founder of Indigeneous Tech Private Limited, Bangalore-32 with 10 years of experience in Blockchain for his valuable guidance and technical support for our project.

We extend our thanks to all our teaching staffs of the department of computer science. Finally, we thank one and all who helped us directly and indirectly for the completion of our project.



## ABSTRACT

Purpose of this project is to design, develop and demonstrate the usage of TELEVISION PURCHASE SHOP using ETHEREUM BLOCKCHAIN having the following features:

- Download and install "METAMASK" wallet as the extension of chrome browser
- Download and install the latest version of "GANACHE ETHEREUM TEST BLOCKCHAIN"
- Link the "METAMASK" to the "first account" of the "GANACHE TEST ETHEREUM BLOCKCHAIN" and verify the quantity of ether available in Metamask's account
- Download and install NodeJS for Windows Platform 20
- Verify the successful installation of "NodeJS" and "npm" through Windows terminal (using "cmd" command)
- Install Truffle through Windows terminal and verify its version after installation
- Download and Install "Visual Studio code" editor and verify
- After setting Up the Environment ,Compile,Migrate and Test METAMASK,GANACHE,NODEJS,TRUFFLE,VISUAL STUDIO CODE in windows platform and Run the Project
- Display the front-end on the default Browser with available Pets for Purchase in the Shop
- Purchase a Pet by clicking on the "Purchase" button
- Metamask should be able to calculate the transaction fees for storing the purchase transaction in the Ganache Blockchain
- Ganache should record the purchase transaction and it should be verifiable
- Pet once purchased should not have the option of purchasing again
- Using one Ganache Ethereum Account the Account holder should be able to purchase more than one Pet
- Using different Ganache Ethereum accounts, the account holder should be able to purchase Pets and verify the related transactions in Ganache



॥ ज्ञानं विद्यायां शान्तिः ॥

**THE NATIONAL COLLEGE**  
**Autonomous**  
**Jayanagar, Bangalore-560070**

**Project Report on**  
**Ethereum Blockchain based**

**E-Voting for Aircraft Design Approval Application**

**BY**

**Rohit V**

**20NCJB421**



PRINCIPAL  
The National College  
Jayanagar, Bangalore-70.

**Under the guidance of**  
**Prof VARADARAJ R**



**E-Voting for Aircraft project report submitted in partial fulfilment of the**  
**requirements of**

**VI Semester BCA, THE NATIONAL COLLEGE JAYANAGAR, Bangalore.**





|| ಪ್ರದ್ಯುತಿ ಪರಮಾ ಗತಿ: ||

**THE NATIONAL COLLEGE**  
**Autonomous**  
**Jayanagar, Bangalore-560070**

**CERTIFICATE**

This is to certify the project report titled "eVoting for Aircraft Design Approval Application" is a work done by **Rohit V** of THE NATIONAL COLLEGE, Jayanagar, Bengaluru, in partial fulfilment of the requirements of VI Semester BCA during the year 2022-2023.

  
**HEAD OF THE DEPARTMENT**  
Head Dept. of BCA  
The National Degree College  
(Autonomous)  
Jayanagar, Bangalore - 560 070  
**Examiners:**

1.

2.



  
**PROJECT GUIDE**

**Examination Centre**

National College, Jayanagar

Date of Examination:

22/08/2023

## ACKNOWLEDGEMENT

eVoting for Aircraft Design Approval Application is the project of many hands from the team. Our tribute for the successful completion of the project goes to all those who helped through their constant guidance and encouragement. The satisfaction that accompanies the success would be incomplete without thanking person who made it.

We are thankful to our beloved Principal **Dr B SURESHA**, who encourages us to come with new and innovative ideas and for providing the environment with all facilities for completing the project.

We are also grateful to our Head of the Department **Prof ASHA T S** and project guide **Prof VARADARAJ R** lecturer Department of computer science for her/his valuable guidance and constant support during our project development.

We are also grateful to **MUTHURAM GOVINDARASU** CEO and Founder of Indigeneous Tech Private Limited, Bangalore-32 with 10 years of experience in Blockchain for his valuable guidance and technical support for our project.

We extend our thanks to all our teaching staffs of department of computer science. Finally, we thank one and all who helped us directly and indirectly for the completion of our project.



## ABSTRACT

- Download and install "METAMASK" wallet as the extension of chrome browser.
- Download and install the latest version of "GANACHE ETHEREUM TEST BLOCKCHAIN"
- Link the "METAMASK" to the "first account" of the "GANACHE TEST ETHEREUM BLOCKCHAIN" and verify the quantity of ether available in Metamask's account
- Download and install NodeJS for Windows Platform20
- Verify the successful installation of "NodeJS" and "npm" through Windows terminal (using "cmd" command)
- Install Truffle through Windows terminal and verify its version after installation.
- Download and Install "Visual Studio code" editor and verify
- After setting Up the Environment Compile, Migrate and Test METAMASK, GANACHE, NODEJS, TRUFFLE, VISUAL STUDIO CODE in windows platform and Run the Project
- Display the front-end on the default Browser of the Voting application for company Board Resolution.
- Create a voting for company board resolution.
- Metamask should be able to calculate the transaction fees for creating a voting campaign and registration of voters.

- Ganache should record the registered voters' transaction and it should be verifiable.
- Using one Ganache Ethereum Account voter once voted should not be able to Vote again.
- Using different Ganache Ethereum accounts, the account holder should be able to vote for their candidate and verify the related transactions in Ganache.





॥ ಶ್ರದ್ಧಾಹಿ ಪರಮಾ ಗತಿಃ ॥

**THE NATIONAL COLLEGE**  
**Autonomous**  
**Jayanagar, Bangalore-560070**

**PROJECT REPORT ON**  
**Hyperledger Fabric Blockchain based Passport Status**  
**Application**

**BY**

**SAGAR N**

**[20NCJB423]**



**Under the guidance of**  
**Prof. VARADARAJ R**

*[Signature]*  
PRINCIPAL  
The National College  
Jayanagar, Bangalore-70.

**Hyperledger Fabric Blockchain based Passport Status Application report**

submitted in partial fulfilment of the requirements of

VI Semester BCA,

**THE NATIONAL COLLEGE, JAYANAGAR**





॥ ಶ್ರದ್ಧಾಹಿ ಪರಮಾ ಗತಿಃ ॥

**THE NATIONAL COLLEGE**  
**Autonomous**  
**Jayanagar, Bangalore-560070**

**CERTIFICATE**

This is to certify the project report titled "**Hyperledger Fabric Blockchain based Passport Status Application**" is a work done by **SAGAR N** of **THE NATIONAL COLLEGE, Jayanagar, Bengaluru**, in partial fulfilment of the requirements of **VI Semester BCA** during the year **2023**.

  
**HEAD OF THE DEPARTMENT**  
Head. Dept. of Comp. Science  
The National Degree College  
(Autonomous)  
Jayanagar, Bangalore - 560 070

  
**PROJECT GUIDE**

Examiners:

1.

2.



Examination Centre

The National College,  
Jayanagar.

Date of Examination:



---

## **ACKNOWLEDGEMENT**

**Hyperledger Fabric Blockchain based Passport Status Application** project is a unique project using the important AWS Services. Our tribute for the successful completion of the project goes to all those who helped through their constant guidance and encouragement. The satisfaction that accompanies the success would be incomplete without thanking the person who made it.

We are thankful to our beloved Principal **Dr. B Suresha** who encourages us to come with new and innovative ideas and for providing the environment with all facilities for completing the project.

We are also grateful to our Head of the Department **Prof. Asha T S** Department of Computer Science for her valuable guidance and constant support during our project development.

We are also grateful to our project guide **Prof. VARADARAJ R** lecturer Department of Computer Science for his valuable guidance and constant support during our project development.

A special thanks to **MUTHURAM GOVINDARASU** CEO and Founder of Indigeneous Tech Private Limited, Bangalore-32 with vast years of experience in Blockchain for his valuable guidance and technical support for our project.

We extend our thanks to all our teaching staffs of the Department of Computer Science. Finally, we thank one and all who helped us directly and indirectly for the completion of our project.

---





|| ಶ್ರದ್ಧಾಢ ಪರಮಾ ಗತಿಃ ||

**THE NATIONAL COLLEGE**  
**Autonomous**  
**Jayanagar, Bangalore-560070**

**PROJECT REPORT**  
**ON**  
**HYPERLEDGER FABRIC BLOCKCHAIN BASED**  
**CBFTIG APPLICATION**

**BY**

**Talari Narsimha**

**20NJB429**

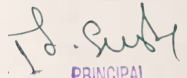

**Under the guidance of**  
**Prof. VARADARAJ**

  
**PRINCIPAL**  
**The National College**  
**Jayanagar, Bangalore-70.**

**CBFTIG project report submitted in partial fulfilment of the requirements**  
**of**  
**VI Semester BCA, THE NATIONAL COLLEGE JAYANAGAR**





|| ಪ್ರದ್ಯಾಹ್ನ ಪರಮಾ ಗತಿಃ ||

**THE NATIONAL COLLEGE**  
**Autonomous**  
**Jayanagar, Bangalore-560070**

**CERTIFICATE**

This is to certify the project report titled "CBFTIG Application" is a work done by **Talari Narsimha** of THE NATIONAL COLLEGE, Jayanagar, Bengaluru, in partial fulfilment of the requirements of VI Semester BCA during the year 2022-2023.

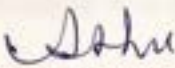
  
**HEAD OF THE DEPARTMENT**  
Head, Dept. of Comp. Science  
The National Degree College  
(Autonomous)  
Jayanagar, Bangalore - 560 070

**Examiners:**

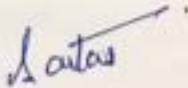
1. 

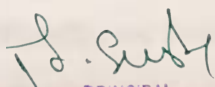
2.   
PRINCIPAL  
The National College  
Jayanagar, Bangalore-70.

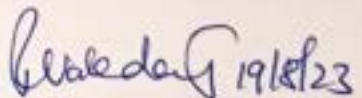

  
**PROJECT GUIDE**

**Examination Centre**

**The National College,  
Jayanagar.**

**Date of Examination: 22/8/23**

## ACKNOWLEDGEMENT

CBFTIG Application is the project of many hands from the team. Our tribute for the successful completion of the project goes to all those who helped through their constant guidance and encouragement. The satisfaction that accompanies the success would be incomplete without thanking the person who made it.

I am thankful to our beloved Principal **Dr.B SURESHA**, who encourages us to come with new and innovative ideas and for providing the environment with all facilities for completing the project.

I am also grateful to our Head of the Department **Prof. ASHA TS** Department of computer science for her valuable guidance and constant support during our project development.

I am also grateful to our project guide **Prof. VARADARAJ**, lecturer Department of computer science for his valuable guidance and constant support during our project development.

A special thanks to **MUTHURAM GOVINDARASU**, CEO and Founder of Indigeneous Tech Private Limited, Bangalore-32 with 10 years of experience in Blockchain for his valuable guidance and technical support for our project.

I extend our thanks to all our teaching staffs of the department of computer science. Finally, we thank one and all who helped us directly and indirectly for the completion of our project.



## Table of Contents

<b>I</b>	<b>Project Goal (Problem Statement)</b> .....	7
<b>II</b>	<b>Solution Proposed</b> .....	7
<b>III</b>	<b>Input Data and Verification</b> .....	10
<b>IV</b>	<b>Project/ Solution (CBFTW) Design</b> .....	12
<b>V</b>	<b>Tools/ Technologies Used</b> .....	17
<b>VI</b>	<b>Project Team Members</b> .....	17
<b>VII</b>	<b>Referenced Documents:</b> .....	18
<b>VIII</b>	<b>Project / Solution Setup</b> .....	18
1)	<b>AWS free-tier Account and EC2 Instance creation and connection</b> .....	18
a)	Create an AWS free-tier account and further create an EC2 instance with Ubuntu Operating System AMI .....	18
b)	Connect to the AWS EC2 Instance through "PuTTY" Software and open the Terminal. Change over to "root" directory with Admin permissions .....	18
2)	<b>Download the required pre-requisite tools and Software into the EC2 Instance, transfer the "CBFTIG" Project files from Windows System to EC2 Instance using "FileZilla" and setup the project in the EC2 Instance</b> .....	18
a)	Download and install all the pre-required tools and software for the Hyperledger Fabric based Blockchain set-up in the created EC2 Instance .....	19
b)	In the EC2 instance, clone the "fabric-samples" directory, download and install the Hyperledger Based Blockchain Binaries Version 1.4.6 and download the Hyperledger based Docker images from Docker hub .....	19
c)	Transfer these program and files from Windows System to the created AWS EC2 Instance using the "FileZilla" software .....	19
d)	Go to "CBFTIG-network" directory and create Cryptographic based certificates and update the "docker-compose.yaml" file with the relevant CA certificate and save the file 19	
e)	Create a directory "channel-artifacts" and create genesis.block and channel.tx files under that directory and verify. Covert the "start.sh" file into an executable file .....	19
f)	Go to "CBFTIG" directory and covert the "startCBFTIG.sh" and "teardownCBFTIG.sh" files into executable ones .....	19
g)	Execute the command "npm install" and verify the creation of "node_modules" directory .....	19
<b>IX</b>	<b>Project / Solution Execution</b> .....	20
1)	In the "CBFTW" directory, execute the command "startCBFTIG.sh" command and verify that the Blockchain Network is up and deployed .....	20
2)	Verify that all the required docker containers are up and running .....	21
3)	Enroll the "Admin" into Blockchain Network executing the "enrollAdmin.js" file .....	22
4)	Register "User1" into the Blockchain Network executing the "registerUser.js" file .....	22

## CBFTW APPLICATION

5) Query and list all the records (Bank , Customer and Forex records) that have got instantiated into the Blockchain by the Smart contract "banks.go" using "queryAll_Data.js" file.....	23
6) Query the specified Bank record and verify .....	23
7) Query the specified Customer record and verify .....	24
8) Query the specified Forex record and verify .....	24
9) Add a new Bank record into the Blockchain then query the created record and verify it.....	24
10) Add a new Customer data into the Blockchain and then query that record and verify it.....	25
11) Add a new Forex rate data into the Blockchain and then query that record and verify it.....	26
2) Pay the Customer US_John_Doe_123 with 1000 EURO units from Customer EU_Marcos_999 and verify.....	26
3) Query and Verify the Customers (EU_Marcos_999 and US_John_Doe_123) data and note down their new account balances and verify.....	27
4) Query the current reserves of Japanese_Bank and UK_Bank in the Blockchain ....	28
<b>X) Setup and loading of "CBFTIG Frontend" .....</b>	<b>29</b>
1) Open the "/CBFTW-front/src/App.js" file and update the Public IP address of the CBFTW Project EC2 Instance and save the file .....	29
2) From the "CBFTW" directory, execute the command "node CBFTW-backend.js" and verify the display of "Listening on port 4001" .....	32
3) Create a duplicate session of the EC2 Instance, navigate to "CBFTW-front" directory in that instance, execute the command "npm run start" and verify the successful starting of the React App Development Server.....	32
4) Load the "CBFTW-frontend" onto the Chrome browser by using the url: "http://Public IP of the Instance:3000/" and verify the successful display of the CBFTW Application frontend .....	35
<b>XI) Interaction with the CBFTIG Blockchain Network using CBFTW Frontend .....</b>	<b>36</b>
1) Click on "QUERY ALL" option and then "SEARCH ALL" button. Verify the display of all the available data under "Info" window.....	36
2) Query an existing Bank and verify: Click on QUERY, enter "US_Bank" then click on "SEARCH" button .....	37
3) Query an existing Customer and verify the data: Click on QUERY, enter "US_Alice_456" then click on "SEARCH" button .....	38
4) Query an existing Forex Pair and verify the value: Click on QUERY, enter "USD:JPY" then click on "SEARCH" button .....	39
5) Create a new Customer: Click on the CREATE CUSTOMER option, enter the new Customer details and then click on "CREATE CUSTOMER" button.....	40
6) Query the created Customer and verify: Click on the QUERY option, enter the created Customer details and then click on "SEARCH" button .....	41
7) Create a new Bank : Click on the CREATE BANK option, enter the new Bank details and then click on "CREATE BANK" button .....	41



8) Query the created Bank and verify: Click on the QUERY option, enter the created Bank details and then click on "SEARCH" button.....	42
9) Create a new Forex: Click on the CREATE FOREX option, enter the new Forex details and then click on "CREATE FOREX" button.....	43
10) Query the created Forex: Click on the QUERY option, enter the created Query details and then click on "SEARCH" button .....	44
11) Query and verify the Customers (IND_Ramu_111 and EU_Marcos_999) data and note down their current account balances (for verifying the successful transfer of fund between them).....	44
12) Query and verify the Banks (IND_Bank and EU_BankRamu_111 and EU_Bank) data and note down their current reserve amounts (for verifying the successful change in their reserves).....	45
13) Pay 1,000 units in Indian currency (INR) from the IND_Bank Customer "IND_Ramu_111" to the EU_Bank Customer "EU_Marcos_999" and verify .....	46
14) Query and Verify the Customers (IND_Ramu_111 and EU_Marcos_999) data and note down their current account balances (for verifying the successful changes in the accounts' balances).....	47
15) Query and verify the Banks (IND_Bank and EU_Bank) data and note down their current reserve amounts (for verifying the successful change in the Banks' reserves) ...	48
XII) Closing of "CBFTIG" Project.....	49
XIII) Project Summary .....	52

## I) Project Goal (Problem Statement)

To design, develop and verify the Hyperledger Fabric based Blockchain application namely "CBFTW Application" having the following features:

- 1) Query from the Banks Network's data that is available as part of the Blockchain (Reading bulk data from the Blockchain)
- 2) Query any one of the Banks Network's data that is available as part of the Blockchain (Reading individual record or data from the Blockchain)
- 3) Add a new Bank, Customer, Forex Value data and verify that these values get added successfully into the Blockchain (Writing new records into the blockchain and its verification)
- 4) Pay from any one of the Banks' Customer Account to any other Bank's Customer Account across the available Banks in the network effectively using the applicable Forex rates without any Third-party involvement (Cross Border Funds Transfer across the World (CBFTW)). Further verifying the successful transfer of the fund across the Customer accounts.

Note: These verifications need to be done both in Command Line Interface (CLI) mode and also using browser based front-end mode.

## II) Solution Proposed

- 1) We will design, develop, implement and verify the Hyperledger Fabric based Blockchain network namely "CBFTW Application" in an Ubuntu O/S based EC2 Instance in AWS.
- 2) We will write the required Blockchain configuration and other files so as to bring-up the Blockchain network
- 3) We will write a Golang program namely "banks.go" in which we will implement the main logic of the Solution.
- 4) In the banks.go program, we will design the below given Data structures:





। ಶ್ರದ್ಧಾಹಿ ಪರಮಾ ಗತಃ ।

**THE NATIONAL COLLEGE**  
**Autonomous**  
**Jayanagar, Bangalore-560070**

**PROJECT REPORT**  
**ON**  
**HYPERLEDGER FABRIC BLOCKCHAIN BASED**  
**FABBIKE APPLICATION**

**BY**

**TRUPTI N**

**20NCJB430**

**Under the guidance of**

**Prof. VARADARAJ**



*Principals*

**FabBike project report submitted in partial fulfillment of the requirements**

**of**  
**The National College**  
**Jayanagar, Bangalore-70**

**VI Semester BCA, THE NATIONAL COLLEGE JAYANAGAR**



|| ತ್ರದ್ಯಾಹಿ ಪರಮಾ ಗತಿಃ ||

**THE NATIONAL COLLEGE**  
**Autonomous**  
**Jayanagar, Bangalore-560070**

**CERTIFICATE**

This is to certify the project report titled "FabBike Application" is a work done by **TRUPTI N** of THE NATIONAL COLLEGE, Jayanagar, Bengaluru, in partial fulfillment of the requirements of VI Semester BCA during the year 2023.

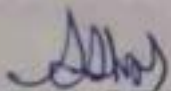
  
**HEAD OF THE DEPARTMENT**

Head Dept. of Comp. Science  
The National Degree College  
(Autonomous)  
Jayanagar, Bangalore - 560 070

**Examiners:**

1.

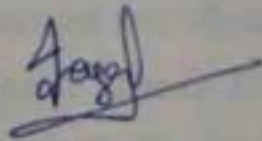
2. 

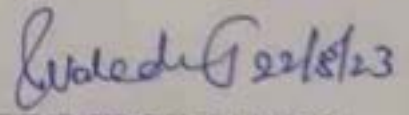
  
**PROJECT GUIDE**

**Examination Centre**

**The National College,  
Jayanagar.**

**Date of Examination:**

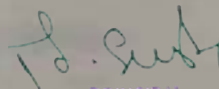

  
**PRINCIPAL**  
The National College  
Jayanagar, Bangalore-70



## ACKNOWLEDGEMENT

FabBike Application is the project of many hands from the team. Our tribute for the successful completion of the project goes to all those who helped through their constant guidance and encouragement. The satisfaction that accompanies the success would be incomplete without thanking the person who made it.

We are thankful to our beloved Principal **Dr.B SURESHA**, who encourages us to come with new and innovative ideas and for providing the environment with all facilities for completing the project.

We are also grateful to our Head of the Department **Prof. ASHA TS** Department of Computer Science for her valuable guidance and constant support during our project development.

We are also grateful to our project guide **Prof. VARADARAJ**, lecturer Department of Computer Science for his valuable guidance and constant support during our project development.

A special thanks to **MUTHURAM GOVINDARASU**, CEO and Founder of Indigeneous Tech Private Limited, Bangalore-32 with 10 years of experience in Blockchain for his valuable guidance and technical support for our project.

We extend our thanks to all our teaching staffs of the department of Computer Science. Finally, we thank one and all who helped us directly and indirectly for the completion of our project.

**Table of Contents**

I) Project Goal (Problem Statement)	6
II) Solution Proposed	7
III) Input Data and Verification	9
IV) Project/ Solution (FabBike) Design	9
V) Tools/ Technologies Used	12
VI) Project Team Members	12
VII) Project / Solution Setup	13
1) Account and EC2 Instance creation and connection	13
a) Create an AWS free account and further create an EC2 instance with Ubuntu Operating System	13
b) Connect to the AWS EC2 Instance through "Putty" Software and open the Terminal. Change over to "root" directory with Admin permissions	13
2) Download the required pre-requisite tools and Software into the EC2 Instance, transfer the "FabBike" Project files from Windows System to EC2 Instance using "FileZilla" and setup the project in the EC2 Instance	13
a) Download and install all the pre-required tools and software for the Hyperledger Fabric based Blockchain set-up in the created EC2 Instance	13
b) In the EC2 instance, clone the "fabric-samples" directory, download and install the Hyperledger Based Blockchain Binaries Version 1.4.6 and download the Hyperledger based Docker images from Docker hub.	13
c) Transfer these program and files from Windows System to the created AWS EC2 Instance using the "FileZilla" software	13
d) Go to "fabbike-network" directory and create Cryptographic based certificates and update the "docker-compose.yaml" file with the relevant CA certificate and save the file	13
e) Create a directory "channel-artifacts" and create genesis.block and channel.tx files under that directory and verify. Covert the "start.sh" file into an executable file	13
f) Go to "fabbike" directory and covert the "startFabBike.sh" and "teardownFabBike.sh" files into executable ones	13
g) Execute the command "npm install" and verify the creation of "node_modules" directory	13
VII) Project / Solution Execution .....	14
1) In the "fabbike" directory, execute the command "./StartFabBike.sh" command and verify that the Blockchain Network is up and deployed	14
2) Execute the command "node enrollAdmin.js" and verify that the "Admin" is enrolled successfully	16
3) Execute the command "node registerUser.js" and verify that the "user1" is registered and enrolled successfully	17
4) Execute the command "node query-All-Bikes.js" and verify that the all the bike data stored inside the blockchain are read and displayed successfully	17



- 5) Execute the command “node query-BIKE4.js” and verify that the BIKE4 details are read from the blockchain and displayed successfully18
- 6) Execute the command “node invoke-BIKE10.js” and check that the BIKE10 has got stored into the blockchain successfully18
- 7) Execute the command “node query-BIKE10.js” and check that the BIKE10 data is read from the blockchain and displayed successfully19
- 8) Execute the command “node invoke-BIKE10-Owner-change.js” and check that the new owner of BIKE10 has got stored into the blockchain successfully19
- 9) Execute the command “node query-BIKE10.js” and check that the BIKE10 data is read from the blockchain and displayed successfully with new bike owner19

#### IX) Setup and loading of “FabBike Frontend”20

- 1) Open the “/fabbike-front/src/App.js” file and update the Public IP address of the fabbike EC2 Instance and save the file20
- 2) From the “fabbike” directory, execute the command “node fabbike-backend.js” and verify the display of “Listening on port 4001”23
- 3) Create the duplicate session of the EC2 Instance, navigate to “fabbike-front” directory in that instance, execute the command “npm run start” and verify the successful starting of the React App Development Server23
- 4) Load the “fabbike-frontend” onto the Chrome browser by using the url: “http://Public IP of the Instance:3000/” and verify the successful display of the fabbike frontend25

#### X) Interaction with the FabBike Blockchain Network using FabBike Frontend from Windows System Browser26

- 1) Click on “QUERY ALL” option and then “SEARCH ALL” button26
- 2) Click on QUERY, enter BIKE4 and then click on “SEARCH” button27
- 3) Click on CREATE option, enter the new Bike details and then click on “CREATE” button27
- 4) Click on QUERY option, enter BIKE11 and click on “SEARCH” button28
- 5) Click on TRANSFER option, enter BIKE11 for BIKE ID and Prakash for New Owner and then click on “TRANSFER” button29
- 6) Click on QUERY option, enter BIKE11 and click on “SEARCH” button30

#### XI) Closing of “FabBike” Project31

#### XII) Project Summary34



॥ ಶ್ರದ್ಧಾಢ ಪರಮಾ ಗತಿಃ ॥

**THE NATIONAL COLLEGE**  
**Autonomous**  
**Jayanagar, Bangalore-560070**

**Project Report on**  
**Ethereum Blockchain based**

**E-Voting for Aircraft Design Approval Application**

**BY**

**Varun K**

**20NCJB431**



**Under the guidance of**  
**Prof VARADARAJ R**

*[Signature]*  
**PRINCIPAL**  
**The National College**  
**Jayanagar, Bangalore-70**

**E-Voting for Aircraft project report submitted in partial fulfilment of the**  
**requirements of**

**VI Semester BCA, THE NATIONAL COLLEGE JAYANAGAR, Bangalore.**





|| ಶ್ರದ್ಧಾಹಿ ಪರಮಾ ಗತಿಃ ||

**THE NATIONAL COLLEGE**  
**Autonomous**  
**Jayanagar, Bangalore-560070**

**CERTIFICATE**

This is to certify the project report titled "eVoting for Aircraft Design Approval Application" is a work done by **Varun K** of THE NATIONAL COLLEGE, Jayanagar, Bengaluru, in partial fulfilment of the requirements of VI Semester BCA during the year 2022-2023.

  
**HEAD OF THE DEPARTMENT**

Head. Dept. of Comp. Science  
The National Degree College  
(Autonomous)

Examiners: Bangalore - 560 070

  
**PROJECT GUIDE**

Examination Centre

National College, Jayanagar

Date of Examination:

22/08/2023

1.

2. 



  
**PRINCIPAL**  
The National College  
Jayanagar, Bangalore-70.

## ACKNOWLEDGEMENT

eVoting for Aircraft Design Approval Application is the project of many hands from the team. Our tribute for the successful completion of the project goes to all those who helped through their constant guidance and encouragement. The satisfaction that accompanies the success would be incomplete without thanking person who made it.

We are thankful to our beloved Principal **Dr B SURESHA**, who encourages us to come with new and innovative ideas and for providing the environment with all facilities for completing the project.

We are also grateful to our Head of the Department **Prof ASHA T S** and project guide **Prof VARADARAJ R** lecturer Department of computer science for her/his valuable guidance and constant support during our project development.

We are also grateful to **MUTHURAM GOVINDARASU** CEO and Founder of Indigeneous Tech Private Limited, Bangalore-32 with 10 years of experience in Blockchain for his valuable guidance and technical support for our project.

We extend our thanks to all our teaching staffs of department of computer science. Finally, we thank one and all who helped us directly and indirectly for the completion of our project.



## ABSTRACT

- Download and install "METAMASK" wallet as the extension of chrome browser.
- Download and install the latest version of "GANACHE ETHEREUM TEST BLOCKCHAIN"
- Link the "METAMASK" to the "first account" of the "GANACHE TEST ETHEREUM BLOCKCHAIN" and verify the quantity of ether available in Metamask's account
- Download and install NodeJS for Windows Platform20
- Verify the successful installation of "NodeJS" and "npm" through Windows terminal (using "cmd" command)
- Install Truffle through Windows terminal and verify its version after installation.
- Download and Install "Visual Studio code" editor and verify
- After setting Up the Environment Compile, Migrate and Test METAMASK, GANACHE, NODEJS, TRUFFLE, VISUAL STUDIO CODE in windows platform and Run the Project
- Display the front-end on the default Browser of the Voting application for company Board Resolution.
- Create a voting for company board resolution.
- Metamask should be able to calculate the transaction fees for creating a voting campaign and registration of voters.

- Ganache should record the registered voters' transaction and it should be verifiable.
- Using one Ganache Ethereum Account voter once voted should not be able to Vote again.
- Using different Ganache Ethereum accounts, the account holder should be able to vote for their candidate and verify the related transactions in Ganache.



SL No.	TABLE OF CONTENTS	Pg no.
I.	Project Goal (Problem Statement)	1
II.	Solution Proposed	1
III.	Input Data	1
IV.	Project Team Members	1
V.	Referenced Documents:	2
VI.	Project/ Solution (eVoting for Aircraft Application) Design	2
VII.	Tools/ Technologies Used	4
VIII.	Install the Tools required for the Ethereum Based Blockchain Project in Windows System	4
IX.	Setup the Ethereum Blockchain based Project "eVoting for Aircraft Design Approval Application" in the Windows System	4
X.	Project Execution	5
1.	Start the Desktop version of Ganache (Test Ethereum Blockchain)	5
2.	Sign-in to the Metamask, select the network "Ganache Desktop Network7545", import the first account of the Ganache Blockchain and make sure that the account is in "connected" state. Rename the account as "Admin-Acct"	6
3.	Compile and deploy the smart contract on to Ethereum Test Blockchain on to Ganache using Ether through Metamask. Further deploy the frontend onto your default Browser	8
4.	Click on "ADMIN" option and fill-in the relevant info under "About Admin", "About eVoting" and click on "Start eVoting" button. Click on the "Confirm" button of the Metamask. Verify that the eVoting process got started	10
5.	Click on "Add Design" option and fill-in the info related to the Designs for which you need eVoting. Create 3 Designs for eVoting	13
6.	Click on "Registration" and register 4 Voters	23
7.	Select the "Admin-Account" in Metamask, refresh the screen, click on "Verification" link and as an Admin approve all the 4 Voters	28
8.	Click on "Voting" link and check the Aircraft Info displayed	29
9.	Select the "Vote1-Acct" in Metamask, make sure that the account is in "connected" status, refresh the screen, confirm that "Vote" buttons are enabled now, click on "Vote" button against the Design titled "Deccan Aviation"	31
10.	Select the "Vote2-Acct" in Metamask, make sure that the account is in "connected" status, refresh the screen, confirm that "Vote" buttons are enabled now, click on "Vote" button against the Design "Matrix Aviation"	33
11.	Select the "Vote3-Acct" in Metamask, make sure that the account is in "connected" status, refresh the screen, confirm that "Vote" buttons are enabled now, click on "Vote" button against the Design "Sky Blue Aviation"	35
12.	Select the "Vote4-Acct" in Metamask, make sure that the account is in "connected" status, refresh the screen, confirm that "Vote" buttons are enabled now, click on "Vote" button against the Design titled "Deccan Aviation"	37
13.	Select "Admi-Acct", make sure that the account is in "connected" status, refresh the page, click on "ADMIN" and click on "eVoting End" button as an Admin	39
14.	Click on "Results" link and verify the eVoting Results	39
XI.	Project Summary	40
XII.	Bibliography	40

## I) Project Goal (Problem Statement)

To design, develop and verify the "eVoting for Aircraft Design Approval Application" having the following features:

- a) Display the front-end of the Application on the default Browser.
- b) Setup the "Admin" related info and start the eVoting process.
- c) Add 3 Designs for eVoting.
- d) Register 4 Voters.
- e) As an "Admin" approve all the 4 Voters.
- f) Perform eVoting for Aircraft using 4 Voters account.
- g) As an "Admin" close the eVoting Process.
- h) Verify the result of eVoting.

## II) Solution Proposed

We will design, develop, implement and verify the Ethereum Blockchain based solution namely "eVoting for Aircraft Application" which will be executed in a Windows System. The proposed Solution will meet all the features specified in the Problem statement.

### II) Input Data

SLNO	Design Names	Voting Symbol
1.	Deccan Aviation	Aircraft Design 01
2.	Matrix Aviation	Aircraft Design 02
3.	Blue Sky Aviation	Aircraft Design 03

### III) Project Team Members:

- Rohit V (20NCJB421)
- Varun K (20NCJB431)
- Vivek Kumar A (20NCJB452)



#### IV) Referenced Documents:

- 1) **Appendix-A:** 02-Appendix-A-Install-and-Setup-Metmask-Ganache-Nodejs-Truffle-VisualStudioCode-in-Windows-Platform-21-Jun-2023.docx.
- 2) **Appendix-B:** 03-Appendix-B-Ethereum-Project-eVoting-for-Election-Setup-21-Jun-2023.docx.
- 3) **Appendix-C:** 04-Appendix-C-Programs-and-Files-Used-in-eVoting-for-Election-Application-21-Jun-2023.docx.

#### V) Project/ Solution (eVoting for Aircraft Application) Design

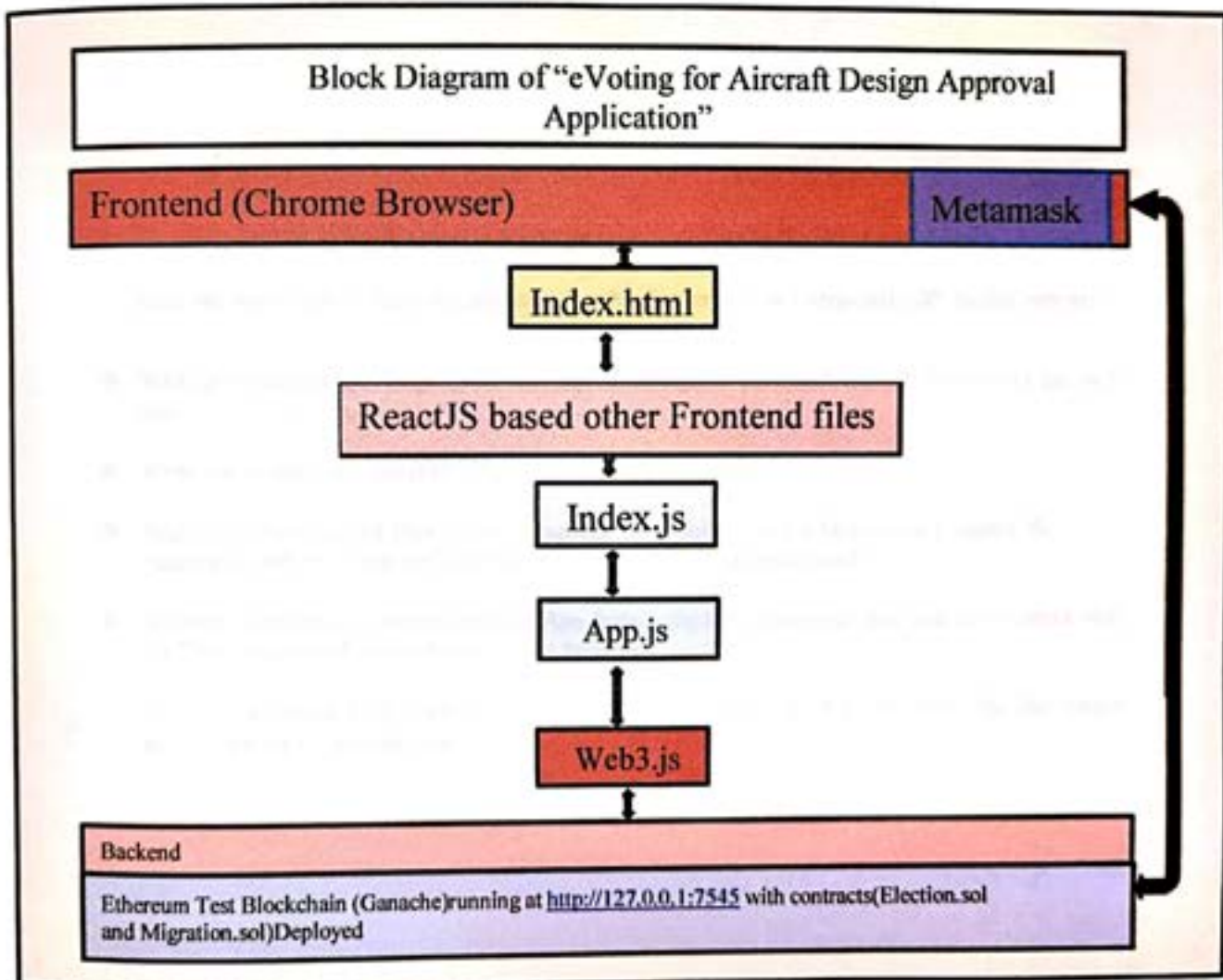

## **High Level:**

Create / provide the following in the Windows System:

- Create and set the Ethereum Blockchain environment in the Windows system.
- Create the Project folders and files using "Truffle" in the Windows System.
- Write the Solidity program "Election.sol" capturing the main logic of the solution.
- Write the required frontend, middleware and other required files for the solution.

## **Details:**

- ❖ Set-up the Ethereum Blockchain environment in the Windows System by installing NodeJS, NPM, Truffle, Ganache and Metamask  
**(For the above given Step (a), please refer the Document at "Appendix-A" to this report)**
- ❖ By using Truffle, setup the project folder and required files in the Windows System.  
**(For the above given Step (b), please refer the Document at "Appendix-B" to this report)**
- ❖ Write a Solidity language program namely "Evoting.sol" in which we will implement the main logic of the Solution.
- ❖ Write the middleware program using JavaScript and Web3.js
- ❖ Start the Ethereum Test Blockchain "Ganache" and sign-in to the Metamask. Connect the Metamask with the Ganache Test Blockchain by importing an account
- ❖ We will also create a frontend (React App based) for the solution so that you can interact with the Blockchain application through your browser.  
**(For the list along with content of programs used in the project, please refer the Document at "Appendix-C" to this report)**



## VI) Tools/ Technologies Used

### a) List of Tools and Technologies

- O/S: Windows 10
- Browser: Chrome Browser
- Nodejs and NPM
- Truffle
- Ganache (Ethereum Test Blockchain)
- Metamask
- HTML
- CSS
- JavaScript
- Web3.js
- Front-end Tools:
- HTML, CSS
- ReactJS

### b) Backend:

- Ethereum based Test Blockchain linked with Metamask

### c) Middleware:

- JavaScript with Web3.js

## VII) Install the Tools required for the Ethereum Based Blockchain Project in Windows System

(For the detailed instructions, please refer "Appendix-A" document of this Project Report)

## VIII) Setup the Ethereum Blockchain based Project "eVoting for Aircraft Design Approval Application" in the Windows System

(For the detailed instructions, please refer "Appendix-B" document of this Project Report)

(For the list of programs and files used in this project, please refer "Appendix-C" document of this Project Report)







|| ಶ್ರೀಮತು ವಿದ್ಯಾಪತಿ ಸ್ಮಾರಕ ||

**THE NATIONAL COLLEGE**  
**Autonomous**  
**Jayanagar, Bangalore-560070**

**PROJECT REPORT**  
**ON**  
**ETHEREUM BLOCKCHAIN BASED PET'S ADOPTION**  
**APPLICATION**

**BY**

**VASANTH KUMAR S**

**20NCJB432**

**Under the guidance of**

**Prof. VARADARAJ R**

**Pet's Adoption Project report submitted in partial fulfilment of the  
requirements of**

**VI Semester BCA, National College, Jayanagar, Bangalore**



|| ಶ್ರೀಗಣೇ ನಮಃ ||

**THE NATIONAL COLLEGE**  
**Autonomous**  
**Jayanagar, Bangalore-560070**

**PROJECT REPORT**  
**ON**  
**ETHEREUM BLOCKCHAIN BASED PET'S ADOPTION**  
**APPLICATION**

**BY**

**VASANTH KUMAR S**

**20NCJB432**



**Under the guidance of**

**Prof. VARADARAJ R**

  
**PRINCIPAL**  
**The National College**  
**Jayanagar, Bangalore-70.**

**Pet's Adoption Project report submitted in partial fulfilment of the**  
**requirements of**  
**VI Semester BCA, National College, Jayanagar, Bangalore**





|| ಪ್ರವೃತ್ತಿ ಪರಮಾ ಗತಿ: ||

**THE NATIONAL COLLEGE**  
**Autonomous**  
**Jayanagar, Bangalore-560070**

**CERTIFICATE**

This is to certify the project report titled "Pet's Adoption Application" is a work done by **Vasanth Kumar S** of THE NATIONAL COLLEGE, Jayanagar, Bengaluru, in partial fulfilment of the requirements of VI Semester BCA during the year 2022-2023.

*AMNS*  
**HEAD OF THE DEPARTMENT**  
Head Dept. of Comp. Science  
The National Degree College  
(Autonomous)  
Jayanagar, Bangalore - 560 070

*Watedaf 19/5/23*  
**PROJECT GUIDE**

**Examiners:**

1. *Watedaf*
2. *Jayal*

**Examination Centre**

**The National College, Jayanagar**

**Date of Examination:**



*To. Subh*  
**PRINCIPAL**  
**The National College**  
**Jayanagar, Bangalore-70.**

## ACKNOWLEDGEMENT

Pet's' Adoption Application is the project of many hands from the team. Our tribute for the successful completion of the project goes to all those who helped through their constant guidance and encouragement. The satisfaction that accompanies the success would be incomplete without thanking the person who made it.

We are thankful to our beloved Principal **Dr.B SURESHA**, who encourages us to come with new and innovative ideas and for providing the environment with all facilities for completing the project.

We are also grateful to our Head of the Department **Prof. ASHA TS** Department of computer science for her valuable guidance and constant support during our project development.

We are also grateful to our project guide **Prof. VARADARAJ R**, lecturer Department of computer science for his valuable guidance and constant support during our project development.

A special thanks to **MUTHURAM GOVINDARASU**, CEO and Founder of Indigeneous Tech Private Limited, Bangalore-32 with 10 years of experience in Blockchain for his valuable guidance and technical support for our project.

We extend our thanks to all our teaching staffs of the department of computer science. Finally, we thank one and all who helped us directly and indirectly for the completion of our project.



## Table of Contents

I	Project Goal (Problem Statement)	6
II	Solution Proposed	6
III	Input Data and Images	6
IV	Project Team Members	7
V	Referenced Documents	7
VI	Project Solution (Pet's Adoption) Design	7
VII	Tools/ Technologies Used	9
VIII	Project Team Members	Error! Bookmark not defined.
IX	Referenced Documents	Error! Bookmark not defined.
X	Set-up, Compile and deployment of the Project "Pet's Adoption" on to Test Ethereum Blockchain "Ganache" using Metamask	9
	1) Setup the Project Folder	9
	a) Copy the given Project folder under "c:\user\username" directory and confirm	9
	b) Open the Windows Terminal and change over to the Project Folder, list the directory and confirm the availability of Project Files	10
	c) Execute the command "npm Install" and verify the availability of "node_modules" directory	11
	2) Compile and deploy the "Pet's Adoption" Project	11
	a) Compile the contract files and verify the creation of "build" directory	11
	b) Start the Ganache Test Blockchain	12
	c) Start and unlock the Metamask Wallet. Select "Ganache Network". Import the first account of Ganache Test Blockchain and confirm	13
	d) Deploy the contracts on to Ganache Test Blockchain and verify	19
XI	Start the Dev Server and verify the deployment of the project's frontend on to the default browser of the Windows System	23
	1) Start the Dev Server (lite-server)	23
	2) Verify the display of the Project's frontend in the Chrome Browser	24
XII	Interactions with the "Pet's Adoption" application using the frontend	25
	1) Adoption a "Pet" using the currently connected Ethereum Account	25
	a) Click on "Adoption" button given under any one of the Pet pictures	25
	b) Check on the Metamask account displayed and make sure that your recently imported account is displayed and it is loaded with 100 Ethers	26
	c) Now, click on "Adoption" button given under any one of the Pet pictures	31
	d) Verify the Metamask Wallet display (like Account Info, Estimated Gas Fee, Total Fees) and then click on "Confirm" button	31
	e) Verify that the clicked "Adoption" button is changed to "Success". The Ethereum Account info is displayed under Adoption	32



f) Verify that the Adoptionr's Ethereum account info is captured in the "List of Adoptionrs" .....	33
g) Verify the Ganache TX COUNT, Transaction and New Block Creation....	33
2) Adoption a second "Pet" with the same Ethereum Account.....	35
a) Click on "Adoption" button below any of the Pet pictures which has not been Adoptiond so far.....	35
b) Verify the Metamask Wallet display (like Account Info, Estimated Gas Fee, Total Fees) and then click on "Confirm" button .....	36
c) Verify that the "Adoption" button has changed into "Success" and the "Adoptionr" Account address is getting displayed below the picture of Adoptiond Pet. Also, verify that the Adoptionr's Ethereum account info is captured in the "List of Adoptionrs".....	37
d) Verify the Ganache TX COUNT, Transaction and New Block Creation....	38
3) Adoption a "Pet" with the another Ethereum Account .....	39
a) Copy the Private key of the Second Ethereum account in Ganache .....	39
b) Select the "Ganache Network" in the Metamask, import an account, paste the just copied Private Key and click on "Confirm" button.....	40
c) Connect the imported account to the "Ganache Test Blockchain and verify.....	43
d) Click on "Adoption" button given under any one of the Pet pictures which has not been Adoptiond so far.....	47
e) Click on "Confirm" button in the Metamask .....	48
f) Verify that the "Adoption" button has changed into "Success" and the current "Adoptionr" Account address is getting displayed below the picture of Adoptiond Pet. Also, verify that the Adoptionr's Ethereum account info is captured in the "List of Adoptionrs".....	49
g) Verify the Ganache TX COUNT, Transaction and New Block Creation....	49
<b>XIII) Project Summary</b> .....	51



## I) Project Goal (Problem Statement)

To design, develop and verify the "Pet's Adoption Application" having the following features:

- Display the front-end on the default Browser with available Pet's for Adoption in the
- Adoption a Pet by clicking on the "Adoption" button
- Metamask should be able to calculate the transaction fees for storing the Adoption transaction in the Ganache Blockchain
- Ganache should record the Adoption transaction and it should be verifiable
- Pet once Adopted should not have the option of purchasing again
- Using one Ganache Ethereum Account the Account holder should be able to Adoption more than one Pet
- Using different Ganache Ethereum accounts, the account holder should be able to Adoption Pet's and verify the related transactions in Ganache

## II) Solution Proposed

- We will design, develop, implement and verify the Ethereum Blockchain based solution namely "Pet's Adoption Application" which will be executed in a Windows System. The proposed Solution will meet all the features specified in the Problem statement

## III) Input Data and Images

### Pet's Input Data:

id	name	picture	age	price	location	purchaser
0	Scottish Terrier	images/scottish-terrier.jpeg	3	30,000	Koramangala, Bangalore	Not purchased
1	Golden-retriever	images/golden-retriever.jpeg	3	10,000	Vijayanagar, Bangalore	Not purchased
2	French Bulldog	images/french-bulldog.jpeg	2	80,000	Banshankari, Bangalore	Not purchased
3	Boxer	images/boxer.jpeg	2	15,000	Marathahalli, Bangalore	Not purchased
4	French Bulldog	images/french-bulldog.jpeg	2	80,000	Gandhi Nagar, Bangalore	Not purchased
5	Scottish Terrier	images/scottish-terrier.jpeg	3	30,000	Whitefield, Bangalore	Not purchased
6	Golden-retriever	images/golden-retriever.jpeg	3	10,000	Yelahanka, Bangalore	Not purchased
7	Boxer	images/boxer.jpeg	3	15,000	Jakkur, Bangalore	Not purchased
8	Scottish Terrier	images/scottish-terrier.jpeg	2	30,000	Indira Nagar, Bangalore	Not purchased
9	Boxer	images/boxer.jpeg	3	15,000	KR Puram, Bangalore	Not purchased
10	French Bulldog	images/french-bulldog.jpeg	2	80,000	Kasturi Nagar, Bangalore	Not purchased
11	Golden-retriever	images/golden-retriever.jpeg	3	10,000	RT Nagar, Bangalore	Not purchased
12	Scottish Terrier	images/scottish-terrier.jpeg	3	30,000	Vijayanagar, Bangalore	Not purchased
13	Golden-retriever	images/golden-retriever.jpeg	4	10,000	Hebbal, Bangalore	Not purchased
14	Boxer	images/boxer.jpeg	2	15,000	Vidyaranipura, Bangalore	Not purchased
15	French Bulldog	images/french-bulldog.jpeg	2	80,000	Rajajinagar, Bangalore	Not purchased

Pet's Images:



**IV) Project Team Members**

- 1) Vasanth Kumar s
- 2) NNSRS Abhiram
- 3) NNSRS Abhiram

**V) Referenced Documents:**

- 1) **Appendix-A:** 02-Install-and-Setup-Metmask-Ganache-Nodejs-Truffle-VisualStudioCode-in-Windows-Platform-03-Sep-2022.docx
- 2) **Appendix-B:** 03-Ethereum-Blockchain-Project-Setup-from-Scratch-03-Sep-2022.docx
- 3) **Appendix-C:** 04-Programs-and-Files-Used-in-Pet's-Adoption--Application-03-Sep-2022.docx

**VI) Project/ Solution (Pet's Adoption ) Design**

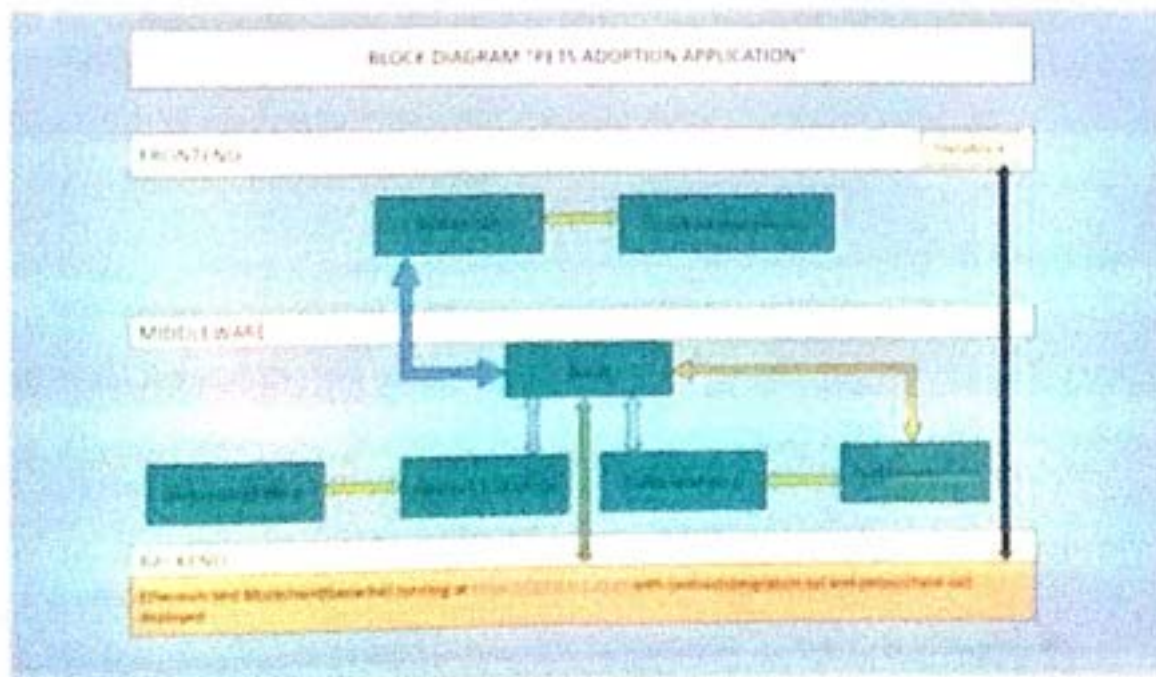



**High Level:**

- 1) Create / provide the following in the Windows System:
  - a) Create and set the Ethereum Blockchain environment in the Widows system
  - b) Create the Project folders and files using "Truffle" in the Windows System
  - c) Write the Solidity program "Pet'sAdoption.sol" capturing the main logic of the solution
  - d) Write the required frontend, middleware and other required files for the solution
  - e) Provide the Solution data using .JSON file
  - f) Place the required Pet's' image files in the appropriate Folder

**Details:**

- a) Set-up the Ethereum Blockchain environment in the Windows System by installing NodeJS, NPM, Truffle, Ganache and Metamask

**(For the above given Step (a), please refer the Document at "Appendix-A" to this report)**

- b) By using Truffle, setup the project folder and required files in the Windows System.

**(For the above given Step (b), please refer the Document at "Appendix-B" to this report)**

- c) Write a Solidity language program namely "Pet'sAdoption.sol" in which we will implement the main logic of the Solution.
- d) Write the middleware program using JavaScript and Web3.js
- e) Start the Ethereum Test Blockcahin "Ganache" and sign-in to the Metamask. Connect the metmask with two accounts of the Ganache Test Blockchain
- f) We will also create a frontend (HTML and CSS based) for the solution so that you can interact with the Blockchain application through your browser.

**(For the list along with content of programs used in the project , please refer the Document at "Appendix-C" to this report)**







|| ಶ್ರದ್ಧಾಹಿ ಪರಮಾ ಗತಿಃ ||

**THE NATIONAL COLLEGE**  
**Autonomous**  
**Jayanagar, Bangalore-560070**

**PROJECT REPORT**  
**ON**  
**ETHEREUM BLOCKCHAIN BASED TELEVISION**  
**PURCHASE SHOP APPLICATION**

**BY**

**KAVITHA M**

**20NCJB437**

**Under the guidance of**

**Prof. VARADARAJ.R**

**Television Purchase Shop Project report submitted in partial**  
**fulfilment of the requirements of**  
**VI Semester BCA, National College, Jayanagar, Bangalore**



॥ ಶ್ರದ್ಧಾಹಿ ವರಮಾ ಗತಿಃ ॥

**THE NATIONAL COLLEGE**  
**Autonomous**  
**Jayanagar, Bangalore-560070**

**CERTIFICATE**

This is to certify the project report titled  
"Television Purchase Shop Application" is a work done by  
**KAVITHA M**  
of THE NATIONAL COLLEGE, Jayanagar, Bengaluru, in partial  
fulfilment of the requirements of VI Semester BCA during the year  
2022-2023.

  
**HEAD OF THE DEPARTMENT**

Head Dept of Comn Science  
The National Degree College  
(Autonomous)  
Jayanagar, Bangalore - 560 070

  
**PROJECT GUIDE**

**Examiners:**

**Examination Centre**

1.

**The National College, Jayanagar**

2. 

**Date of Examination:**



  
**PRINCIPAL**  
The National College  
Jayanagar, Bangalore-70



## ACKNOWLEDGEMENT

Television Purchase Shop Application is the project of many hands from the team. Our tribute for the successful completion of the project goes to all those who helped through their constant guidance and encouragement. The satisfaction that accompanies the success would be incomplete without thanking the person who made it.

We are thankful to our beloved Principal **Dr.B.SURESHA**, who encourages us to come with new and innovative ideas and for providing the environment with all facilities for completing the project.

We are also grateful to our Head of the Department **Prof. ASHA T S** Department of computer science for her valuable guidance and constant support during our project development.

We are also grateful to our project guide **Prof. VARADARAJ.R**, lecturer Department of computer science for his valuable guidance and constant support during our project development.

A special thanks to **MUTHURAM GOVINDARASU**, CEO and Founder of Indigeneous Tech Private Limited, Bangalore-32 with 10 years of experience in Blockchain for his valuable guidance and technical support for our project.

We extend our thanks to all our teaching staffs of the department of computer science. Finally, we thank one and all who helped us directly and indirectly for the completion of our project.

## ABSTRACT

Purpose of this project is to design, develop and demonstrate the usage of TELEVISION PURCHASE SHOP using ETHEREUM BLOCKCHAIN having the following features:

- Download and install "METAMASK" wallet as the extension of chrome browser
- Download and install the latest version of "GANACHE ETHEREUM TEST BLOCKCHAIN"
- Link the "METAMASK" to the "first account" of the "GANACHE TEST ETHEREUM BLOCKCHAIN" and verify the quantity of ether available in Metamask's account
- Download and install NodeJS for Windows Platform20
- Verify the successful installation of "NodeJS" and "npm" through Windows terminal (using "cmd" command)
- Install Truffle through Windows terminal and verify its version after installation
- Download and Install "Visual Studio code" editor and verify
- After setting Up the Environment ,Compile,Migrate and Test METAMASK,GANACHE,NODEJS,TRUFFLE,VISUAL STUDIO CODE in windows platform and Run the Project
- Display the front-end on the default Browser with available Pets for Purchase in the Shop
- Purchase a Pet by clicking on the "Purchase" button
- Metamask should be able to calculate the transaction fees for storing the purchase transaction in the Ganache Blockchain
- Ganache should record the purchase transaction and it should be verifiable
- Pet once purchased should not have the option of purchasing again
- Using one Ganache Ethereum Account the Account holder should be able to purchase more than one Pet
- Using different Ganache Ethereum accounts, the account holder should be able to purchase Pets and verify the related transactions in Ganache





ಶಿಕ್ಷಣವೇ ಮನೋರಥಃ

**THE NATIONAL COLLEGE**  
**Autonomous**  
**Jayanagar, Bangalore-560070**

**PROJECT REPORT**  
**ON**  
**HYPERLEDGER FABRIC BLOCKCHAIN BASED**  
**CBFTIG APPLICATION**

**BY**

**Sai Pavan A S**

**20NJB440**

**Under the guidance of**

**Prof. VARADARAJ**

  
**PRINCIPAL**

**The National College**  
**Jayanagar, Bangalore-70**

**CBFTIG project report submitted in partial fulfilment of the requirements**

**of**

**VI Semester BCA, THE NATIONAL COLLEGE JAYANAGAR**





|| ಪ್ರದ್ಯೂತಂ ಪರಮಾ ಗತಿಃ ||

**THE NATIONAL COLLEGE**  
**Autonomous**  
**Jayanagar, Bangalore-560070**

**CERTIFICATE**

This is to certify the project report titled "CBFTIG Application" is a work done by **Sai Pavan A S** of THE NATIONAL COLLEGE, Jayanagar, Bengaluru, in partial fulfilment of the requirements of VI Semester BCA during the year 2022-2023.

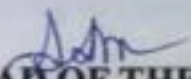
  
**HEAD OF THE DEPARTMENT**

Head. Dept. of Comp. Science  
The National Degree College  
(Autonomous)  
Jayanagar, Bangalore - 560 070

**Examiners:**

1.

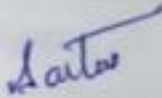

2.

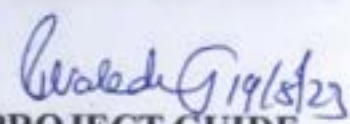

  
**PROJECT GUIDE**

**Examination Centre**

**The National College,  
Jayanagar.**

**Date of Examination: 22/8/23**

  
**PRINCIPAL**  
**The National College**  
**Jayanagar, Bangalore-70.**



## ACKNOWLEDGEMENT

CBFTIG Application is the project of many hands from the team. Our tribute for the successful completion of the project goes to all those who helped through their constant guidance and encouragement. The satisfaction that accompanies the success would be incomplete without thanking the person who made it.

I am thankful to our beloved Principal **Dr.B SURESHA**, who encourages us to come with new and innovative ideas and for providing the environment with all facilities for completing the project.

I am also grateful to our Head of the Department **Prof. ASHA TS** Department of computer science for her valuable guidance and constant support during our project development.

I am also grateful to our project guide **Prof. VARADARAJ**, lecturer Department of computer science for his valuable guidance and constant support during our project development.

A special thanks to **MUTHURAM GOVINDARASU**, CEO and Founder of Indigeneous Tech Private Limited, Bangalore-32 with 10 years of experience in Blockchain for his valuable guidance and technical support for our project.

I extend our thanks to all our teaching staffs of the department of computer science. Finally, we thank one and all who helped us directly and indirectly for the completion of our project.

## Table of Contents

<b>I</b>	<b>Project Goal (Problem Statement)</b> .....	7
<b>II</b>	<b>Solution Proposed</b> .....	7
<b>III</b>	<b>Input Data and Verification</b> .....	10
<b>IV</b>	<b>Project/ Solution (CBFTW) Design</b> .....	12
<b>V</b>	<b>Tools/ Technologies Used</b> .....	17
<b>VI</b>	<b>Project Team Members</b> .....	17
<b>VII</b>	<b>Referenced Documents</b> .....	18
<b>VIII</b>	<b>Project / Solution Setup</b> .....	18
1)	<b>AWS free-tier Account and EC2 Instance creation and connection</b> .....	18
a)	Create an AWS free-tier account and further create an EC2 instance with Ubuntu Operating System AMI .....	18
b)	Connect to the AWS EC2 Instance through "PuTTY" Software and open the Terminal. Change over to "root" directory with Admin permissions .....	18
2)	<b>Download the required pre-requisite tools and Software into the EC2 Instance, transfer the "CBFTIG" Project files from Windows System to EC2 Instance using "FileZilla" and setup the project in the EC2 Instance</b> .....	18
a)	Download and install all the pre-required tools and software for the Hyperledger Fabric based Blockchain set-up in the created EC2 Instance .....	19
b)	In the EC2 instance, clone the "fabric-samples" directory, download and install the Hyperledger Based Blockchain Binaries Version 1.4.6 and download the Hyperledger based Docker images from Docker hub. ....	19
c)	Transfer these program and files from Windows System to the created AWS EC2 Instance using the "FileZilla" software .....	19
d)	Go to "CBFTIG-network" directory and create Cryptographic based certificates and update the "docker-compose.yaml" file with the relevant CA certificate and save the file	19
e)	Create a directory "channel-artifacts" and create genesis.block and channel.tx files under that directory and verify. Convert the "start.sh" file into an executable file .....	19
f)	Go to "CBFTIG" directory and convert the "startCBFTIG.sh" and "teardownCBFTIG.sh" files into executable ones .....	19
g)	Execute the command "npm install" and verify the creation of "node_modules" directory .....	19
<b>IX</b>	<b>Project / Solution Execution</b> .....	20
1)	In the "CBFTW" directory, execute the command "./startCBFTIG.sh" command and verify that the Blockchain Network is up and deployed .....	20
2)	Verify that all the required docker containers are up and running .....	21
3)	Enroll the "Admin" into Blockchain Network executing the "enrollAdmin.js" file	22
4)	Register "User1" into the Blockchain Network executing the "registerUser.js" file	22



CBFTW APPLICATION

5) Query and list all the records (Bank , Customer and Forex records) that have got instantiated into the Blockchain by the Smart contract "banks.go" using "queryAll\_Data.js" file ..... 23

6) Query the specified Bank record and verify ..... 23

7) Query the specified Customer record and verify ..... 24

8) Query the specified Forex record and verify ..... 24

9) Add a new Bank record into the Blockchain then query the created record and verify it ..... 24

10) Add a new Customer data into the Blockchain and then query that record and verify it ..... 25

11) Add a new Forex rate data into the Blockchain and then query that record and verify it ..... 26

2) Pay the Customer US\_John\_Doe\_123 with 1000 EURO units from Customer EU\_Marcos\_999 and verify ..... 26

3) Query and Verify the Customers (EU\_Marcos\_999 and US\_John\_Doe\_123) data and note down their new account balances and verify ..... 27

4) Query the current reserves of Japanese\_Bank and UK\_Bank in the Blockchain.... 28

**X) Setup and loading of "CBFTIG Frontend" ..... 29**

1) Open the "/CBFTW-front/src/App.js" file and update the Public IP address of the CBFTW Project EC2 Instance and save the file ..... 29

2) From the "CBFTW" directory, execute the command "node CBFTW-backend.js" and verify the display of "Listening on port 4001" ..... 32

3) Create a duplicate session of the EC2 Instance, navigate to "CBFTW-front" directory in that instance, execute the command "npm run start" and verify the successful starting of the React App Development Server ..... 32

4) Load the "CBFTW-frontend" onto the Chrome browser by using the url: "http://Public IP of the Instance:3000/" and verify the successful display of the CBFTW Application frontend ..... 35

**XI) Interaction with the CBFTIG Blockchain Network using CBFTW Frontend ..... 36**

1) Click on "QUERY ALL" option and then "SEARCH ALL" button. Verify the display of all the available data under "Info" window ..... 36

2) Query an existing Bank and verify: Click on QUERY, enter "US\_Bank" then click on "SEARCH" button..... 37

3) Query an existing Customer and verify the data: Click on QUERY, enter "US\_Alice\_456" then click on "SEARCH" button ..... 38

4) Query an existing Forex Pair and verify the value: Click on QUERY, enter "USD:JPY" then click on "SEARCH" button ..... 39

5) Create a new Customer: Click on the CREATE CUSTOMER option, enter the new Customer details and then click on "CREATE CUSTOMER" button..... 40

6) Query the created Customer and verify: Click on the QUERY option, enter the created Customer details and then click on "SEARCH" button ..... 41

7) Create a new Bank : Click on the CREATE BANK option, enter the new Bank details and then click on "CREATE BANK" button ..... 41

8) Query the created Bank and verify: Click on the QUERY option, enter the created Bank details and then click on "SEARCH" button ..... 42

9) Create a new Forex: Click on the CREATE FOREX option, enter the new Forex details and then click on "CREATE FOREX" button..... 43

10) Query the created Forex: Click on the QUERY option, enter the created Query details and then click on "SEARCH" button..... 44

11) Query and verify the Customers (IND\_Ramu\_111 and EU\_Marcos\_999) data and note down their current account balances (for verifying the successful transfer of fund between them)..... 44

12) Query and verify the Banks (IND\_Bank and EU\_BankRamu\_111 and EU\_Bank) data and note down their current reserve amounts (for verifying the successful change in their reserves)..... 45

13) Pay 1,000 units in Indian currency (INR) from the IND\_Bank Customer "IND\_Ramu\_111" to the EU\_Bank Customer "EU\_Marcos\_999" and verify ..... 46

14) Query and Verify the Customers (IND\_Ramu\_111 and EU\_Marcos\_999) data and note down their current account balances (for verifying the successful changes in the accounts' balances) ..... 47

15) Query and verify the Banks (IND\_Bank and EU\_Bank) data and note down their current reserve amounts (for verifying the successful change in the Banks' reserves).... 48

XII) **Closing of "CBFTIG" Project** ..... 49

XIII) **Project Summary** ..... 52



## I) Project Goal (Problem Statement)

To design, develop and verify the Hyperledger Fabric based Blockchain application namely "CBFTW Application" having the following features:

- 1) Query from the Banks Network's data that is available as part of the Blockchain (Reading bulk data from the Blockchain)
- 2) Query any one of the Banks Network's data that is available as part of the Blockchain (Reading individual record or data from the Blockchain)
- 3) Add a new Bank, Customer, Forex Value data and verify that these values get added successfully into the Blockchain (Writing new records into the blockchain and its verification)
- 4) Pay from any one of the Banks' Customer Account to any other Bank's Customer Account across the available Banks in the network effectively using the applicable Forex rates without any Third-party involvement (Cross Border Funds Transfer across the World (CBFTW)). Further verifying the successful transfer of the fund across the Customer accounts.

Note: These verifications need to be done both in Command Line Interface (CLI) mode and also using browser based front-end mode.

## II) Solution Proposed

- 1) We will design, develop, implement and verify the Hyperledger Fabric based Blockchain network namely "CBFTW Application" in an Ubuntu O/S based EC2 Instance in AWS.
- 2) We will write the required Blockchain configuration and other files so as to bring-up the Blockchain network
- 3) We will write a Golang program namely "banks.go" in which we will implement the main logic of the Solution.
- 4) In the banks.go program, we will design the below given Data structures:



|| ಶ್ರದ್ಧಾಹಿ ಪರಮಾ ಗತಿಃ ||

**THE NATIONAL COLLEGE**  
**Autonomous**  
**Jayanagar, Bangalore-560070**

**PROJECT REPORT**  
**ON**  
**ETHEREUM BLOCKCHAIN BASED PET'S ADOPTION**  
**APPLICATION**

**BY**

**NM SHASHANK**

**20NCJB441**

**Under the guidance of**

**Prof. VARADARAJ R**



*[Handwritten Signature]*  
**PRINCIPAL**  
**The National College**  
**Jayanagar, Bangalore-70**

**Pet's Adoption Project report submitted in partial fulfilment of the**  
**requirements of**

**VI Semester BCA, National College, Jayanagar, Bangalore**





॥ ಶ್ರದ್ಧಾಹಿ ಪರಮಾ ಗತಿಃ ॥

**THE NATIONAL COLLEGE**  
**Autonomous**  
**Jayanagar, Bangalore-560070**

**CERTIFICATE**

This is to certify the project report titled "Pet's' Adoption Application" is a work done by **NM Shashank** of THE NATIONAL COLLEGE, Jayanagar, Bengaluru, in partial fulfilment of the requirements of VI Semester BCA during the year 2022-2023.

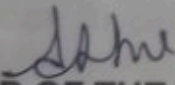
  
**HEAD OF THE DEPARTMENT**

Head. Dept. of Comp. Science  
The National Degree College  
(Autonomous)  
Jayanagar, Bangalore - 560 070

**Examiners:**

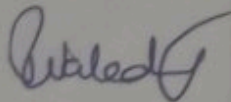
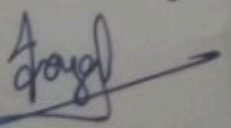
1. 
2. 

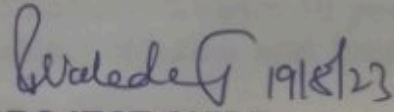
  
**PROJECT GUIDE**

**Examination Centre**

**The National College, Jayanagar**

**Date of Examination:**

### ACKNOWLEDGEMENT

Pet's' Adoption Application is the project of many hands from the team. Our tribute for the successful completion of the project goes to all those who helped through their constant guidance and encouragement. The satisfaction that accompanies the success would be incomplete without thanking the person who made it.

We are thankful to our beloved Principal **Dr.B SURESHA**, who encourages us to come with new and innovative ideas and for providing the environment with all facilities for completing the project.

We are also grateful to our Head of the Department **Prof. ASHA TS** Department of computer science for her valuable guidance and constant support during our project development.

We are also grateful to our project guide **Prof. VARADARAJ R**, lecturer Department of computer science for his valuable guidance and constant support during our project development.

A special thanks to **MUTHURAM GOVINDARASU**, CEO and Founder of Indigeneous Tech Private Limited, Bangalore-32 with 10 years of experience in Blockchain for his valuable guidance and technical support for our project.

We extend our thanks to all our teaching staffs of the department of computer science. Finally, we thank one and all who helped us directly and indirectly for the completion of our project.



## Table of Contents

<b>I</b>	<b>Project Goal (Problem Statement)</b> .....	6
<b>II</b>	<b>Solution Proposed</b> .....	6
<b>III</b>	<b>Input Data and Images</b> .....	6
<b>IV</b>	<b>Project Team Members</b> .....	7
<b>V</b>	<b>Referenced Documents</b> .....	7
<b>VI</b>	<b>Project/ Solution (Pet's' Adoption ) Design</b> .....	7
<b>VII</b>	<b>Tools/ Technologies Used</b> .....	9
<b>VIII</b>	<b>Project Team Members</b> .....	Error! Bookmark not defined.
<b>X</b>	<b>Referenced Documents:</b> .....	Error! Bookmark not defined.
<b>XI</b>	<b>Set-up, Compile and deployment of the Project "Pet's Adoption " on to Test Ethereum Blockchain "Ganache" using Metamask</b> .....	9
	1) Setup the Project Folder .....	9
	a) Copy the given Project folder under "c:\user\username" directory and confirm .....	9
	b) Open the Windows Terminal and change over to the Project Folder, list the directory and confirm the availability of Project Files .....	10
	c) Execute the command "npm Install" and verify the availability of "node_modules" directory .....	11
	2) Compile and deploy the "Pet's Adoption " Project .....	11
	a) Compile the contract files and verify the creation of "build" directory... ..	11
	b) Start the Ganache Test Blockchain .....	12
	c) Start and unlock the Metamask Wallet. Select "Ganache Network". Import the first account of Ganache Test Blockchain and confirm .....	13
	d) Deploy the contracts on to Ganache Test Blockchain and verify .....	19
<b>XI</b>	<b>Start the Dev Server and verify the deployment of the project's frontend on to the default browser of the Windows System</b> .....	23
	1) Start the Dev Server (lite-server) .....	23
	2) Verify the display of the Project's frontend in the Chrome Browser .....	24
<b>XII</b>	<b>Interactions with the "Pet's' Adoption " application using the frontend</b> ....	25
	1) Adoption a "Pet" using the currently connected Ethereum Account .....	25
	a) Click on "Adoption" button given under any one of the Pet pictures ....	25
	b) Check on the Metamask account displayed and make sure that your recently imported account is displayed and it is loaded with 100 Ethers .....	26
	c) Now, click on "Adoption" button given under any one of the Pet pictures .....	31
	d) Verify the Metamask Wallet display (like Account Info, Estimated Gas Fee, Total Fees) and then click on "Confirm" button .....	31
	e) Verify that the clicked "Adoption" button is changed to "Success". The Ethereum Account info is displayed under Adoptionr.....	32



- f) Verify that the Adoptionr's Ethereum account info is captured in the "List of Adoptionrs" ..... 33
- g) Verify the Ganache TX COUNT, Transaction and New Block Creation.... 33
- 2) Adoption a second "Pet" with the same Ethereum Account..... 35
  - a) Click on "Adoption" button below any of the Pet pictures which has not been Adoptiond so far..... 35
  - b) Verify the Metamask Wallet display (like Account Info, Estimated Gas Fee, Total Fees) and then click on "Confirm" button ..... 36
  - c) Verify that the "Adoption" button has changed into "Success" and the "Adoptionr" Account address is getting displayed below the picture of Adoptiond Pet. Also, verify that the Adoptionr's Ethereum account info is captured in the "List of Adoptionrs"..... 37
  - d) Verify the Ganache TX COUNT, Transaction and New Block Creation.... 38
- 3) Adoption a "Pet" with the another Ethereum Account ..... 39
  - a) Copy the Private key of the Second Ethereum account in Ganache ..... 39
  - b) Select the "Ganache Network" in the Metamask, import an account, paste the just copied Private Key and click on "Confirm" button..... 40
  - c) Connect the imported account to the "Ganache Test Blockchain and verify"..... 43
  - d) Click on "Adoption" button given under any one of the Pet pictures which has not been Adoptiond so far..... 47
  - e) Click on "Confirm" button in the Metamask ..... 48
  - f) Verify that the "Adoption" button has changed into "Success" and the current "Adoptionr" Account address is getting displayed below the picture of Adoptiond Pet. Also, verify that the Adoptionr's Ethereum account info is captured in the "List of Adoptionrs"..... 49
  - g) Verify the Ganache TX COUNT, Transaction and New Block Creation.... 49
- XIII) Project Summary** ..... 51





|| ಶ್ರದ್ಧಾಢಿ ವರಮಾ ಗತಿಃ ||

**THE NATIONAL COLLEGE**  
Autonomous  
Jayanagar, Bangalore-560070

**CERTIFICATE**

This is to certify the project report titled "**Bigmart Sales Prediction Solution**" is a work done by **SUHAS A BHARDWAJ [20NCJB444]** of **THE NATIONAL COLLEGE**, Jayanagar, Bengaluru, in partial fulfilment of the requirements of IV Semester BCA during the year 2022.

  
**HEAD OF THE DEPARTMENT**

  
**PROJECT GUIDE**

Examiners:

1.

Dept. Of Comp. Science  
**VALUED**

2.

Examiner

  
Authorised Signatory



Examination Centre

  
PRINCIPAL  
The National College,  
Jayanagar, Bangalore-70

Date of Examination:



॥ ಶ್ರದ್ಧಾ಼ ಪರಮಾ ಗತಿಃ ॥

**THE NATIONAL COLLEGE**  
Autonomous  
Jayanagar, Bangalore-560070

### CERTIFICATE

This is to certify the project report titled "AWS Project using EBS Demonstration using EC2 Windows Server Instances" is a work done by **SUHAS A BHARADWAJ** of THE NATIONAL COLLEGE, Jayanagar, Bengaluru, in partial fulfilment of the requirements of V<sup>th</sup> Semester BCA during the year 2023.

  
HEAD OF THE DEPARTMENT

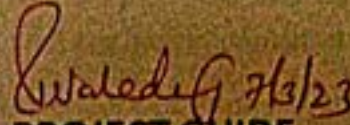
  
PROJECT GUIDE

#### Examiners:

1.  10/13/23
2. 

#### Examination Centre

The National College,  
Jayanagar,

Date of Examination:





|| ಶುಕ್ಲಾ ವಿದ್ಯಾ ನಾ: ||

**THE NATIONAL COLLEGE**  
Autonomous  
Jayanagar, Bangalore-560070

### CERTIFICATE

This is to certify the project report titled "eVoting for Bikes" is a work done by **Suhas A Bharadwaj** of THE NATIONAL COLLEGE Jayanagar Bengaluru, in partial fulfilment of the requirements of VI Semester BCA during the year 2022-2023.

  
**HEAD OF THE DEPARTMENT**

Head, Dept. of Comp. Science  
The National Degree College  
(Autonomous)  
Jayanagar, Bangalore - 560 070

Examiners:

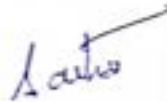
1. 
- 2.

  
**PRINCIPAL**  
The National College  
Jayanagar, Bangalore-70.



  
**PROJECT GUIDE**

Examination Centre

National College, Jayanagar

Date of Examination:



## **I. Introduction**

### **1. Define Project Goal, Problem Statement, Proposed Solution and Solution Steps**

#### **1.1) Project Goal**

To understand the given problem, propose a suitable solution and implement the proposed solution and verify the result.

#### **1.2) Problem Statement**

Design and develop a Regression prediction model by which we can successfully predict the Bigmart Sales values for the given customer data.

#### **1.3) Solution Proposed**

We will design and implement a Python based Regression prediction Model which will learn from the given training data and then predict the Bigmart Sales values for the provided Customer data.

#### **1.4) Solution Steps**

To design, develop and verify the "Bigmart Sales Prediction Solution" having the following features:

- a) To read, analyse, preprocess the given training dataset besides giving the Pre-processed data for using in further programs.
- b) To execute and find out the applicability of remaining Data Preprocessing tasks (Multicollinearity, Outlier data, Feature selection and Dimensionality Reduction) on the Preprocessed dataset.
- c) To execute and verify all the applicable Regression algorithms on the Preprocessed dataset and identify the most suitable Regressor out of these based on the Test/CV based accuracy values.
- d) To predict the Bigmart Sales values for the given Customer data using the finalized Regressor (from Step (c)) and writing out Customer Data file with the predicted values as one of the columns



## 2. Tools and Technologies Used

### 2.1) Tools/ Technologies Used

- O/S: Windows 10 and above 64-bit
- Browser: Chrome Browser
- Google Drive
- Colab (Google Colaboratory)
- Python Notebooks
- Python Libraries
- Regression Algorithms
- Anaconda Navigator-64 bit for windows
- VS code

**Front-end tools:** Streamlit, Python, CSS

**Back-end tools:** CSV file, Pickle file, Machine Learning Algorithms

## Introduction

### 1) Project Goal

To design, develop and demonstrate the usage of AWS EBS Demonstration using EC2 Windows Server Instances by Creating a Custom VPC, Subnets, Route Tables, etc. and Creating EC2 Windows Server Instances and EBS Volume in the just created Custom VPC and Demonstrating the EBS Demo.

### 2) Tools / Technologies Used

Cloud Computing Amazon Web Services (AWS) Services.

- EC2 Windows Server Instances
- Custom VPC, Subnets, Route Tables etc.
- EBS Volume, Snapshots
- Remote Desktops

### 3) Solution Design

Block diagram

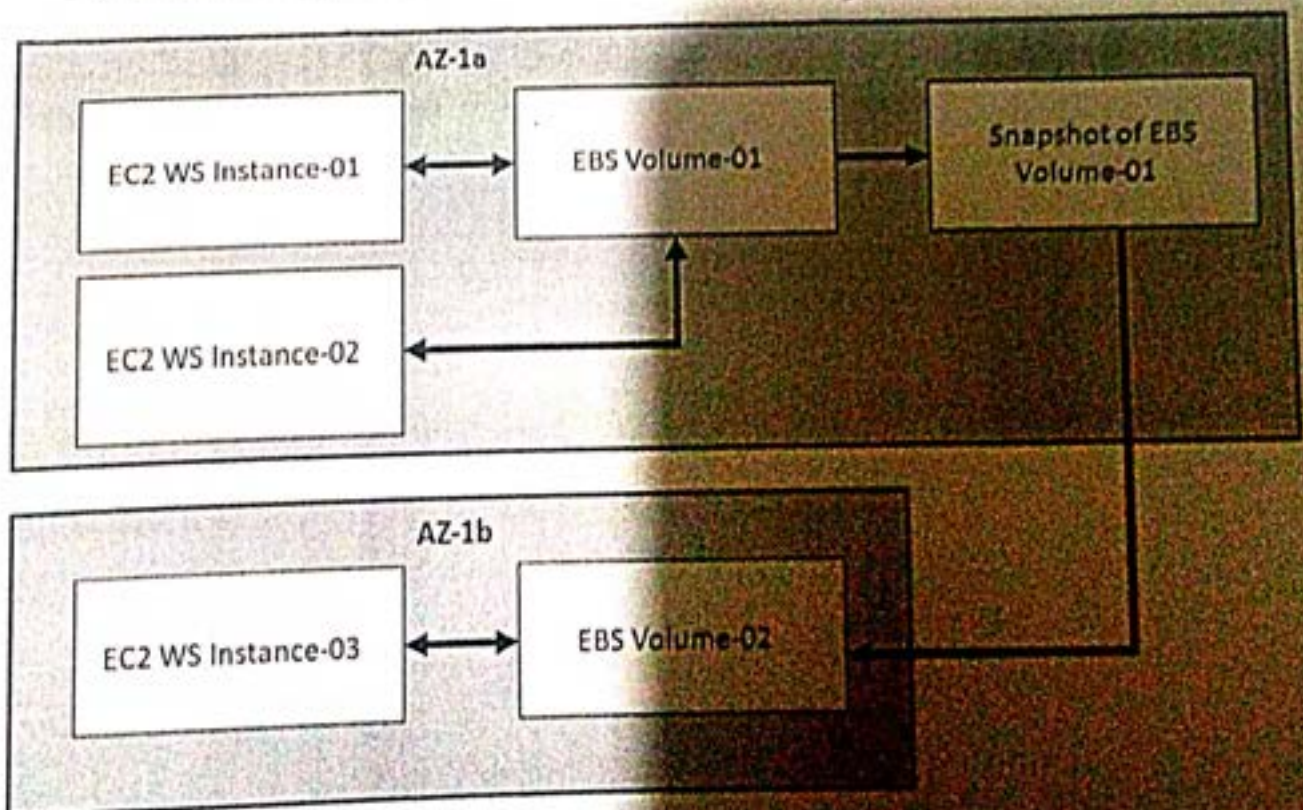



# Table of Contents

I) <b>Project Goal (Problem Statement)</b> .....	5
II) <b>Solution Proposed</b> .....	5
III) <b>Input Data</b> .....	5
IV) <b>Project/ Solution (eVoting for Bikes Application) Design</b> .....	5
V) <b>Tools/ Technologies Used</b> .....	6
VI) <b>Install the Tools required for the Ethereum Based Blockchain Project in Windows System</b> 7	
VII) <b>Setup the Ethereum Blockchain based Project "eVoting for Bikes Application" in the Windows System</b> .....	7
VIII) <b>Project Execution</b> .....	7
1) Execute "ganache-cli" command. Copy the Ether accounts and Private keys in a Notepad. Connect the Metamask with Ganache by importing one of its accounts .....	7
2) Sign-in to the Metamask, select the network "Localhost 8545", import the first account of the Ganache Blockchain and make sure that the account is in "connected" state 8	
3) Compile and deploy the smart contract on to Ethereum Test Blockchain on to Ganache using Ether through Metamask .....	11
4) Click on "ADMIN" option and fill-in the relevant info under "About Admin", "About eVoting" and click on "Start eVoting" button. Click on the "Confirm" button of the Metamask. Verify that the eVoting process got started .....	14
5) Click on "Add bikes" option and fill-in the info related to the books for which you need eVoting. Create 3 bikes for eVoting .....	15
6) <b>Click on "Registration" and register 4 Voters</b> .....	17
7) Select the "Admin-Acct" in Metamask, refresh the screen, click on "Verification" link and as an Admin approve all the 4 Voters .....	24
8) <b>Click on "Voting" link and check the Bikes Info displayed</b> .....	29
9) Select the "Vote1-Acct" in Metamask, make sure that the account is in "connected" status, refresh the screen, confirm that "Vote" buttons are enabled now, click on "Vote" button against the Bike model "R15 V4" .....	29
10) Select the "Vote2-Acct" in Metamask, make sure that the account is in "connected" status, refresh the screen, confirm that "Vote" buttons are enabled now, click on "Vote" button against the Bike model "MT 15" .....	32
11) Select the "Vote3-Acct" in Metamask, make sure that the account is in "connected" status, refresh the screen, confirm that "Vote" buttons are enabled now, click on "Vote" button against the Bike model "RAY ZR" .....	34
12) Select the "Vote4-Acct" in Metamask, make sure that the account is in "connected" status, refresh the screen, confirm that "Vote" buttons are enabled now, click on "Vote" button against the Bike model "FZ X" .....	36
13) Select "Admi-Acct", make sure that the account is in "connected" status, refresh the page, click on "ADMIN" and click on "eVoting End" button as an Admin .....	38
14) <b>Click on "Results" link and verify the eVoting Results</b> .....	38
<b>Project Summary</b> .....	39



## I) Project Goal (Problem Statement)

To design, develop and verify the “eVoting for Bike Application” having the following features:

- a) Display the front-end of the Application on the default Browser
- b) Setup the “Admin” related info and start the eVoting process
- c) Add 3 bikes for eVoting
- d) Register 4 Voters
- e) As an “Admin” approve all the 4 Voters
- f) Perform eVoting for Bikes using 4 Voters account
- g) As an “Admin” close the eVoting Process
- h) Verify the result of eVoting

## II) Solution Proposed

We will design, develop, implement and verify the Ethereum Blockchain based solution namely “eVoting for Bikes Application” which will be executed in a Windows System. The proposed Solution will meet all the features specified in the Problem statement

## III) Input Data

SL.NO	BIKE MODEL	MODEL YEAR
1	RI5 V4	2023
2	MT 15	2020
3	ZAY ZR	2019

## IV) Project/ Solution (eVoting for Bikes Application)



# Block Diagram of ("eVoting for Bikes Application)

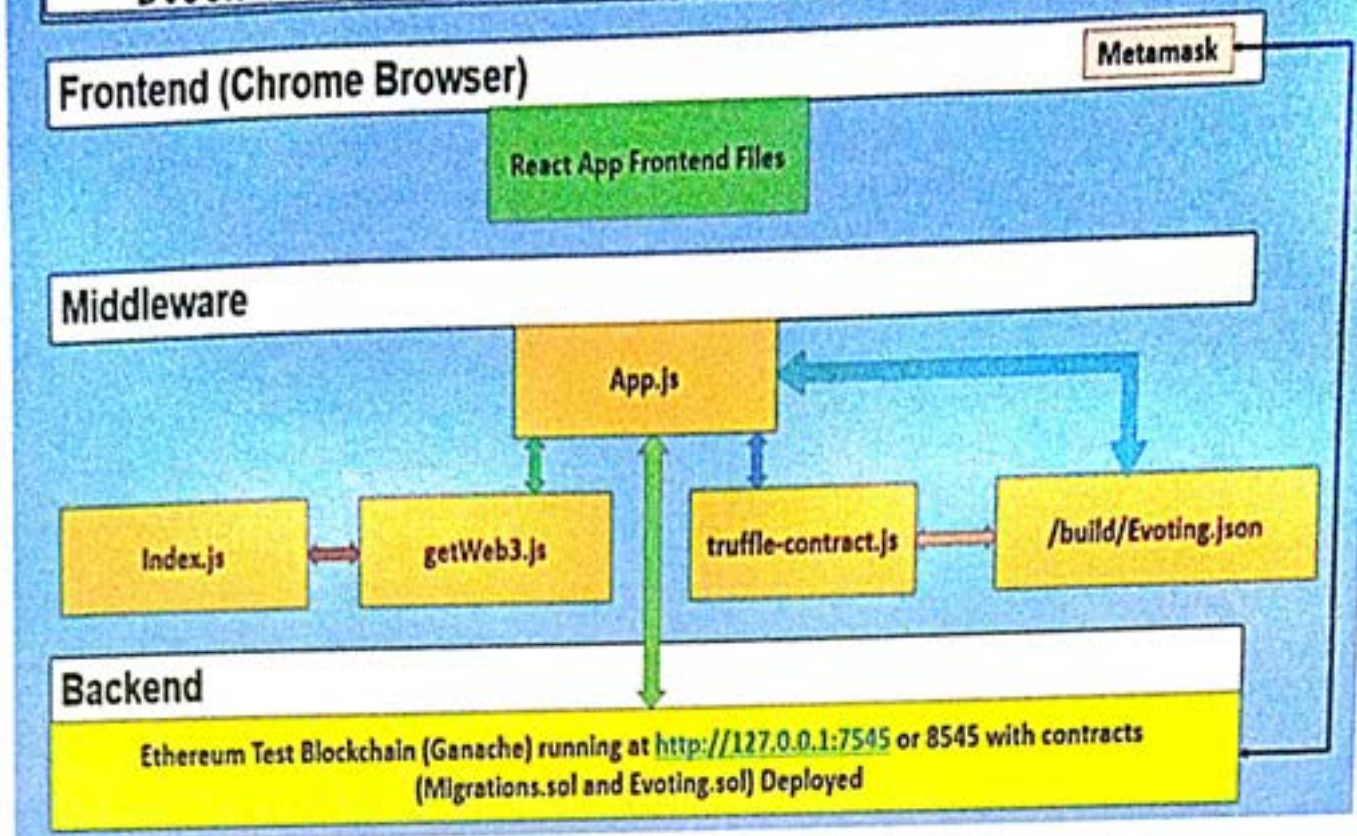

## High Level:

- 1) Create / provide the following in the Windows System:
  - a) Create and set the Ethereum Blockchain environment in the Windows system
  - b) Create the Project folders and files using "Truffle" in the Windows System
  - c) Write the Solidity program "Evoting.sol" capturing the main logic of the solution
  - d) Write the required frontend, middleware and other required files for the solution
  - e) Provide the Solution data using .JSON file

## Details:

- a) Set-up the Ethereum Blockchain environment in the Windows System by installing NodeJS, NPM, Truffle, Ganache and Metamask
- b) By using Truffle, setup the project folder and required files in the Windows System.
- c) Write a Solidity language program namely "Evoting.sol" in which we will implement the main logic of the Solution.



- d) Write the middleware program using JavaScript and Web3.js
- e) Start the Ethereum Test Blockchain "Ganache" and sign-in to the Metamask. Connect the Metamask with the Ganache Test Blockchain by importing an account
- f) We will also create a frontend (React App based) for the solution so that you can interact with the Blockchain application through your browser.

## V) Tools/ Technologies Used

- a) List of Tools and Technologies
  - O/S: Windows 10
  - Browser: Chrome Browser
  - Nodejs and NPM
  - Truffle
  - Ganache (Ethereum Test Blockchain)
  - Metamask
  - HTML
  - CSS
  - JavaScript
  - Web3.js
  - Front-end Tools:
    - HTML, CSS
    - Development Server (lite-server)
- b) Backend:
  - Ethereum based Test Blockchain linked with Metamask
- c) Middleware:
  - JavaScript with Web3.js

## VI) Install the Tools required for the Ethereum Based Blockchain Project in Windows System

(For the detailed instructions, please refer "Appendix-A" document of this Project Report)

## VII) Setup the Ethereum Blockchain for Books Application in the Windows System

(For the detailed instructions, please refer "Appendix-B" document of this Project Report)





|| ಶ್ರದ್ಧಾ ಪರಮಾ ಗತಿ: ||

**THE NATIONAL COLLEGE**  
Autonomous  
Jayanagar, Bangalore-560070

**ETHEREUM BLOCKCHAIN BASED ON  
E-VOTING FOR BEST FILM AWARD**

**BY**

**ABDUL LATHIF T**

**20NJCB446**

**Under the guidance of**

**Prof. VARDARAJ R**

  
PRINCIPAL  
The National College  
Jayanagar, Bangalore-70.



**E-Voting for Best film award project report submitted in partial fulfilment of the  
requirements of**

**VI Semester BCA, THE NATIONAL COLLEGE JAYANAGAR**



|| ಶ್ರದ್ಧಾ ಪರಮಾ ನಮಃ ||

**THE NATIONAL COLLEGE**  
Autonomous  
Jayanagar, Bangalore-560070

**CERTIFICATE**

This is to certify the project report titled "evoitng for Best Film Award" is a work done by **ABDUL LATHIF T** of **THE NATIONAL COLLEGE, Jayanagar, Bengaluru**, in partial fulfilment of the requirements of VI Semester BCA during the year 2022-2023.

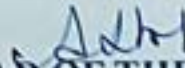
  
**HEAD OF THE DEPARTMENT**  
Head, Dept. of Com. Inform. Studies  
The National Degree College  
(Autonomous)  
Jayanagar, Bangalore - 560 070

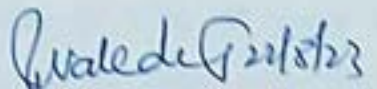
  
**PROJECT GUIDE**

Examiners:

Examination Centre



1.

The National College, Jayanagar.

2.

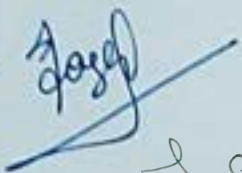
Date of Examination:





## ACKNOWLEDGEMENT

**“E-voting for Best film award”** is the project of many hands from the team. Our tribute for the successful completion of the project goes to all those who helped through their constant guidance and encouragement. The satisfaction that accompanies the success would be incomplete without thanking person who made it.

We are thankful to our beloved Principal **Dr. B SURESH**, who encourages us to come with new and innovative ideas and for providing the environment with all facilities for completing the project.

We are also grateful to our Head of the Department **Prof. ASHA T.S**, and project guide **Prof. VARADARAJ**, lecturer Department of computer science for her valuable guidance and constant support during our project development.

We are also grateful to **MUTHURAM GOVINDARAJU**, CEO and Founder of Indigeneous Tech Private Limited, Bangalore-32 with 10 years of experience in Blockchain for his valuable guidance and technical support for our project.

We extend our thanks to all our teaching staffs of department of computer science. Finally, we thank one and all who helped us directly and indirectly for the completion of our project.



X) Project Execution .....	10
1) Start the Desktop version of Ganache (Test Ethereum Blockchain).....	10
2) Sign-in to the Metamask, select the network "Ganache Desktop Network7545", import the first account of the Ganache Blockchain and make sure that the account is in "connected" state. Rename the account as "Admin-Acct" .....	10
3) Compile and deploy the smart contract on to Ethereum Test Blockchain on to Ganache using Ether through Metamask. Further deploy the frontend onto your default Browser .....	11
4) Click on "ADMIN" option and fill-in the relevant info under "About Admin", "About eVoting" and click on "Start eVoting" button. Click on the "Confirm" button of the Metamask. Verify that the eVoting process got started .....	13
5) Click on "Add Candidate" option and fill-in the info related to the Candidates for which you need eVoting. Create 2 Candidates for eVoting .....	15
6) Click on "Registration" and register 3 Voters .....	15
7) Select the "Admin-Account" In Metamask, refresh the screen, click on "Verification" link and as an Admin approve all the 3 Voters.....	21
8) Click on "Voting" link and check the Election Info displayed.....	27
9) Select the "Vote1-Acct" in Metamask, make sure that the account is in "connected" status, refresh the screen, confirm that "Vote" buttons are enabled now, click on "Vote" button against the Candidate titled "Ramesh Gowda".....	28
10) Select the "Vote2-Acct" in Metamask, make sure that the account is in "connected" status, refresh the screen, confirm that "Vote" buttons are enabled now, click on "Vote" button against the Candidate "Ganesh Shivraj" .....	29
11) Select the "Vote3-Acct" In Metamask, make sure that the account is in "connected" status, refresh the screen, confirm that "Vote" buttons are enabled now, click on "Vote" button against the Candidate "Ramu Gowda" .....	31
12) Select "Admin-Acct", make sure that the account is in "connected" status, refresh the page, click on "ADMIN" and click on "eVoting End" button as an Admin .....	34
13) Click on "Results" link and verify the eVoting Results.....	37
1) Project Summary .....	38



## **I) Project Goal (Problem Statement)**

To design, develop and verify the “eVoting for Election Application” having the following features:

- a) Display the front-end of the Application on the default Browser
- b) Setup the “Admin” related info and start the eVoting process
- c) Add 3 Candidates for eVoting
- d) Register 4 Voters
- e) As an “Admin” approve all the 4 Voters
- f) Perform eVoting for Election using 4 Voters account
- g) As an “Admin” close the eVoting Process
- h) Verify the result of eVoting

## **II) Solution Proposed**

We will design, develop, implement and verify the Ethereum Blockchain based solution namely “eVoting for Election Application” which will be executed in a Windows System. The proposed Solution will meet all the features specified in the Problem statement



|| ಶ್ರದ್ಧಾಃ ಪರಮಾ ಗತಃ ||

**THE NATIONAL COLLEGE**  
**Autonomous**  
**Jayanagar, Bangalore-560070**

**PROJECT REPORT**  
**ON**  
**ETHEREUM BLOCKCHAIN BASED PET'S ADOPTION**  
**APPLICATION**

**BY**

**NNSRS ABHIRAM**

**20NCJB449**



**PRINCIPAL**

**The National College**  
**Jayanagar, Bangalore-70**

**Under the guidance of**

**Prof. VARADARAJ R**



**Pet's Adoption Project report submitted in partial fulfilment of the**  
**requirements of**

**VI Semester BCA, National College, Jayanagar, Bangalore**





॥ ಪ್ರದ್ಯಾಹಿ ಪರಮಾ ಗತಿಃ ॥

**THE NATIONAL COLLEGE**  
**Autonomous**  
**Jayanagar, Bangalore-560070**

### **CERTIFICATE**

This is to certify the project report titled "Pet's' Adoption Application" is a work done by **NNSRS Abhiram** of THE NATIONAL COLLEGE, Jayanagar, Bengaluru, in partial fulfilment of the requirements of VI Semester BCA during the year 2022-2023.

**HEAD OF THE DEPARTMENT**

Head Dept of Comp Science  
The National Degree College  
(Autonomous)  
Jayanagar, Bangalore - 560 070

#### Examiners:

- 1.
- 2.

**PROJECT GUIDE**

#### Examination Centre

**The National College, Jayanagar**

**Date of Examination:**

**PRINCIPAL**  
**The National College**  
**Jayanagar, Bangalore-70**



## ACKNOWLEDGEMENT

Pet's' Adoption Application is the project of many hands from the team. Our tribute for the successful completion of the project goes to all those who helped through their constant guidance and encouragement. The satisfaction that accompanies the success would be incomplete without thanking the person who made it.

We are thankful to our beloved Principal **Dr.B SURESHA**, who encourages us to come with new and innovative ideas and for providing the environment with all facilities for completing the project.

We are also grateful to our Head of the Department **Prof. ASHA TS** Department of computer science for her valuable guidance and constant support during our project development.

We are also grateful to our project guide **Prof. VARADARAJ R**, lecturer Department of computer science for his valuable guidance and constant support during our project development.

A special thanks to **MUTHURAM GOVINDARASU**, CEO and Founder of Indigeneous Tech Private Limited, Bangalore-32 with 10 years of experience in Blockchain for his valuable guidance and technical support for our project.

We extend our thanks to all our teaching staffs of the department of computer science. Finally, we thank one and all who helped us directly and indirectly for the completion of our project.



## Table of Contents

I	Project Goal (Problem Statement)	6
II	Solution Proposed	6
III	Input Data and Images	6
IV	Project Team Members	7
V	Referenced Documents	7
VI	Project Solution (Pet's Adoption) Design	7
VII	Tools/ Technologies Used	9
VIII	Project Team Members	Error! Bookmark not defined.
IX	Referenced Documents	Error! Bookmark not defined.
X	Set-up, Compile and deployment of the Project "Pet's Adoption" on to Test Ethereum Blockchain "Ganache" using Metamask	9
	1) Setup the Project Folder	9
	a) Copy the given Project folder under "c:\user\username" directory and confirm	9
	b) Open the Windows Terminal and change over to the Project Folder, list the directory and confirm the availability of Project Files	10
	c) Execute the command "npm Install" and verify the availability of "node_modules" directory	11
	2) Compile and deploy the "Pet's Adoption" Project	11
	a) Compile the contract files and verify the creation of "build" directory	11
	b) Start the Ganache Test Blockchain	12
	c) Start and unlock the Metamask Wallet. Select "Ganache Network". Import the first account of Ganache Test Blockchain and confirm	13
	d) Deploy the contracts on to Ganache Test Blockchain and verify	19
XI	Start the Dev Server and verify the deployment of the project's frontend on to the default browser of the Windows System	23
	1) Start the Dev Server (lite-server)	23
	2) Verify the display of the Project's frontend in the Chrome Browser	24
XII	Interactions with the "Pet's Adoption" application using the frontend	25
	1) Adoption a "Pet" using the currently connected Ethereum Account	25
	a) Click on "Adoption" button given under any one of the Pet pictures	25
	b) Check on the Metamask account displayed and make sure that your recently imported account is displayed and it is loaded with 100 Ethers	26
	c) Now, click on "Adoption" button given under any one of the Pet pictures	31
	d) Verify the Metamask Wallet display (like Account Info, Estimated Gas Fee, Total Fees) and then click on "Confirm" button	31
	e) Verify that the clicked "Adoption" button is changed to "Success". The Ethereum Account info is displayed under Adoption	32



f) Verify that the Adoptionr's Ethereum account info is captured in the "List of Adoptionrs" .....	33
g) Verify the Ganache TX COUNT, Transaction and New Block Creation....	33
2) Adoption a second "Pet" with the same Ethereum Account.....	35
a) Click on "Adoption" button below any of the Pet pictures which has not been Adoptiond so far.....	35
b) Verify the Metamask Wallet display (like Account Info, Estimated Gas Fee, Total Fees) and then click on "Confirm" button .....	36
c) Verify that the "Adoption" button has changed into "Success" and the "Adoptionr" Account address is getting displayed below the picture of Adoptiond Pet. Also, verify that the Adoptionr's Ethereum account info is captured in the "List of Adoptionrs".....	37
d) Verify the Ganache TX COUNT, Transaction and New Block Creation....	38
3) Adoption a "Pet" with the another Ethereum Account .....	39
a) Copy the Private key of the Second Ethereum account in Ganache .....	39
b) Select the "Ganache Network" in the Metamask, import an account, paste the just copied Private Key and click on "Confirm" button .....	40
c) Connect the imported account to the "Ganache Test Blockchain and verify.....	43
d) Click on "Adoption" button given under any one of the Pet pictures which has not been Adoptiond so far.....	47
e) Click on "Confirm" button in the Metamask .....	48
f) Verify that the "Adoption" button has changed into "Success" and the current "Adoptionr" Account address is getting displayed below the picture of Adoptiond Pet. Also, verify that the Adoptionr's Ethereum account info is captured in the "List of Adoptionrs".....	49
g) Verify the Ganache TX COUNT, Transaction and New Block Creation....	49
<b>XIII) Project Summary</b> .....	51



## I) Project Goal (Problem Statement)

To design, develop and verify the "Pet's Adoption Application" having the following features:

- Display the front-end on the default Browser with available Pet's for Adoption in the
- Adoption a Pet by clicking on the "Adoption" button
- Metamask should be able to calculate the transaction fees for storing the Adoption transaction in the Ganache Blockchain
- Ganache should record the Adoption transaction and it should be verifiable
- Pet once Adopted should not have the option of purchasing again
- Using one Ganache Ethereum Account the Account holder should be able to Adoption more than one Pet
- Using different Ganache Ethereum accounts, the account holder should be able to Adoption Pet's and verify the related transactions in Ganache

## II) Solution Proposed

- We will design, develop, implement and verify the Ethereum Blockchain based solution namely "Pet's Adoption Application" which will be executed in a Windows System. The proposed Solution will meet all the features specified in the Problem statement

## III) Input Data and Images

### Pet's Input Data:

id	name	picture	age	price	location	purchaser
0	Scottish Terrier	images/scottish-terrier.jpeg	3	30,000	Koramangala, Bangalore	Not purchased
1	Golden-retriever	images/golden-retriever.jpeg	3	10,000	Vijayanagar, Bangalore	Not purchased
2	French Bulldog	images/french-bulldog.jpeg	2	80,000	Banshankari, Bangalore	Not purchased
3	Boxer	images/boxer.jpeg	2	15,000	Marathahalli, Bangalore	Not purchased
4	French Bulldog	images/french-bulldog.jpeg	2	80,000	Gandhi Nagar, Bangalore	Not purchased
5	Scottish Terrier	images/scottish-terrier.jpeg	3	30,000	Whitefield, Bangalore	Not purchased
6	Golden-retriever	images/golden-retriever.jpeg	3	10,000	Yelahanka, Bangalore	Not purchased
7	Boxer	images/boxer.jpeg	3	15,000	Jakkur, Bangalore	Not purchased
8	Scottish Terrier	images/scottish-terrier.jpeg	2	30,000	Indira Nagar, Bangalore	Not purchased
9	Boxer	images/boxer.jpeg	3	15,000	KR Puram, Bangalore	Not purchased
10	French Bulldog	images/french-bulldog.jpeg	2	80,000	Kasturi Nagar, Bangalore	Not purchased
11	Golden-retriever	images/golden-retriever.jpeg	3	10,000	RT Nagar, Bangalore	Not purchased
12	Scottish Terrier	images/scottish-terrier.jpeg	3	30,000	Vijayanagar, Bangalore	Not purchased
13	Golden-retriever	images/golden-retriever.jpeg	4	10,000	Hebbal, Bangalore	Not purchased
14	Boxer	images/boxer.jpeg	2	15,000	Vidyaranipura, Bangalore	Not purchased
15	French Bulldog	images/french-bulldog.jpeg	2	80,000	Rajajinagar, Bangalore	Not purchased

### Pet's Images:



### V) Project Team Members

- 1) Vasanth Kumar s
- 3) NNSRS Abhiram

### V) Referenced Documents

- 1) Appendix-A: 02-Install-and-Setup-Metmask-Ganache-Nodejs-Truffle-VisualStudioCode-in-Windows-Platform-03-Sep-2022.docx
- 2) Appendix-B: 03-Ethereum-Blockchain-Project-Setup-from-Scratch-03-Sep-2022.docx
- 3) Appendix-C: 04-Programs-and-Files-Used-in-Pet's-Adoption--Application-03-Sep-2022.docx

### VI) Project/ Solution (Pet's Adoption ) Design

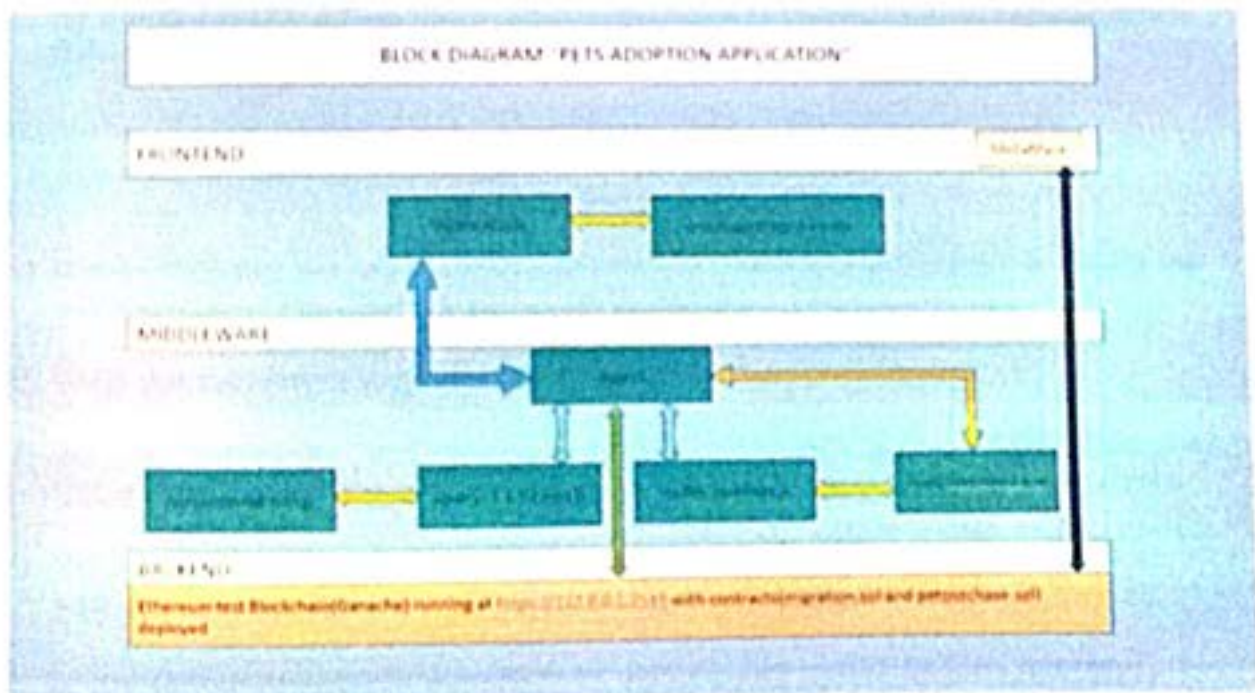



Pet's Images:



**V)Project Team Members**

- 1) Vasanth Kumar s
- 2) NNSRS Abhiram

**V) Referenced Documents:**

- 1) **Appendix-A:** 02-Install-and-Setup-Metmask-Ganache-Nodejs-Truffle-VisualStudioCode-in-Windows-Platform-03-Sep-2022.docx
- 2) **Appendix-B:** 03-Ethereum-Blockchain-Project-Setup-from-Scratch-03-Sep-2022.docx
- 3) **Appendix-C:** 04-Programs-and-Files-Used-in-Pet's-Adoption--Application-03-Sep-2022.docx

**VI)Project/ Solution (Pet's Adoption ) Design**

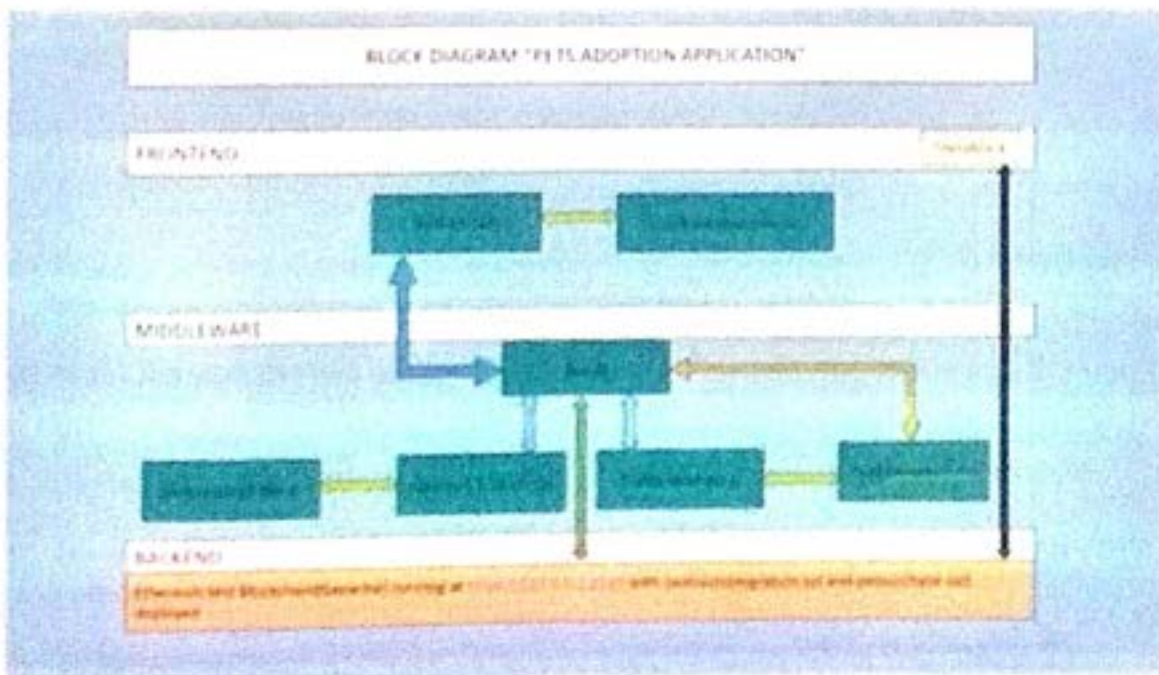

**High Level:**

- 1) Create / provide the following in the Windows System:
  - a) Create and set the Ethereum Blockchain environment in the Windows system
  - b) Create the Project folders and files using "Truffle" in the Windows System
  - c) Write the Solidity program "Pet'sAdoption.sol" capturing the main logic of the solution
  - d) Write the required frontend, middleware and other required files for the solution
  - e) Provide the Solution data using .JSON file
  - f) Place the required Pet's' image files in the appropriate Folder

**Details:**

- a) Set-up the Ethereum Blockchain environment in the Windows System by installing NodeJS, NPM, Truffle, Ganache and Metamask

**(For the above given Step (a), please refer the Document at "Appendix-A" to this report)**

- b) By using Truffle, setup the project folder and required files in the Windows System.

**(For the above given Step (b), please refer the Document at "Appendix-B" to this report)**

- c) Write a Solidity language program namely "Pet'sAdoption.sol" in which we will implement the main logic of the Solution.
- d) Write the middleware program using JavaScript and Web3.js
- e) Start the Ethereum Test Blockchain "Ganache" and sign-in to the Metamask. Connect the metmask with two accounts of the Ganache Test Blockchain
- f) We will also create a frontend (HTML and CSS based) for the solution so that you can interact with the Blockchain application through your browser.

**(For the list along with content of programs used in the project , please refer the Document at "Appendix-C" to this report)**





|| ಶ್ರದ್ಧಾಹಿ ಪರಮಾ ಗಾಃ ||

**THE NATIONAL COLLEGE**  
Autonomous  
Jayanagar, Bangalore-560070

**Project Report on**  
**Ethereum Blockchain based**  
**eVoting for Bike Application**

**BY**

**Prasanna Kumar B**

**20NCJB450**

**Under the guidance of**

**Prof Varadaraj R**

*P. S. Sub*  
PRINCIPAL  
The National College  
Jayanagar, Bangalore-70.



eVoting for Bike project report submitted in partial fulfilment of the  
requirements of

**VI Semester BCA, THE NATIONAL COLLEGE JAYANAGAR**



॥ ज्ञानं विद्यां विद्यां ॥

**THE NATIONAL COLLEGE**  
Autonomous  
Jayanagar, Bangalore-560070

### CERTIFICATE

This is to certify the project report titled "eVoting for Bike" is a work done by **Prasanna Kumar B** of THE NATIONAL COLLEGE Jayanagar Bengaluru in partial fulfilment of the requirements of VI Semester BCA during the year 2022-2023.

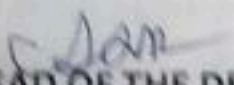
  
**HEAD OF THE DEPARTMENT**

Head, Dept. of Comp. Science  
The National Degree College  
(Autonomous)  
Jayanagar, Bangalore - 560 070

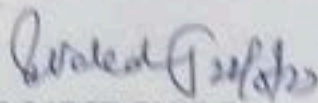
  
**PROJECT GUIDE**

Examiners:

1. 
- 2.

Examination Centre

National College, Jayanagar

Date of Examination:



---

## ACKNOWLEDGEMENT

eVoting for Bikes is the project of many hands from the team. Our tribute for the successful completion of the project goes to all those who helped through their constant guidance and encouragement. The satisfaction that accompanies the success would be incomplete without thanking person who made it.

We are thankful to our beloved Principal **Dr. B SURESHA**, who encourages us to come with new and innovative ideas and for providing the environment with all facilities for completing the project.

We are also grateful to our Head of the Department **Prof. ASHA TS** Department of computer science for her valuable guidance and constant support during our project development.

We are also grateful to our project guide **Prof. VARADARAJ R**, lecturer Department of computer science for his valuable guidance and constant support during our project development.

We are also grateful to **MUTHURAM GOVINDARASU** CEO and Founder of Indigeneous Tech Private Limited, Bangalore-32 with vast years of experience in Blockchain for his valuable guidance and technical support for our project.

We extend our thanks to all our teaching staffs of department of computer science. Finally, we thank one and all who helped us directly and indirectly for the completion of our project.

## Table of Contents

I) Project Goal (Problem Statement)	5
II) Solution Proposed	5
III) Input Data	5
IV) Project Solution (eVoting for Bikes Application) Design	5
V) Tools Technologies Used	6
VI) Install the Tools required for the Ethereum Based Blockchain Project in Windows System	7
VII) Setup the Ethereum Blockchain based Project "eVoting for Bikes Application" in the Windows System	7
VIII) Project Execution	7
1) Execute "ganache-cli" command. Copy the Ether accounts and Private keys in a Notepad. Connect the Metamask with Ganache by importing one of its accounts	7
2) Sign-in to the Metamask, select the network "Localhost 8545", import the first account of the Ganache Blockchain and make sure that the account is in "connected" state	8
3) Compile and deploy the smart contract on to Ethereum Test Blockchain on to Ganache using Ether through Metamask	11
4) Click on "ADMIN" option and fill-in the relevant info under "About Admin", "About eVoting" and click on "Start eVoting" button. Click on the "Confirm" button of the Metamask. Verify that the eVoting process got started	14
5) Click on "Add bikes" option and fill-in the info related to the books for which you need eVoting. Create 3 bikes for eVoting	15
6) Click on "Registration" and register 4 Voters	17
7) Select the "Admin-Account" in Metamask, refresh the screen, click on "Verification" link and as an Admin approve all the 4 Voters	24
8) Click on "Voting" link and check the Bikes Info displayed	29
9) Select the "Vote1-Acct" in Metamask, make sure that the account is in "connected" status, refresh the screen, confirm that "Vote" buttons are enabled now, click on "Vote" button against the Bike model "R15 V4"	29
10) Select the "Vote2-Acct" in Metamask, make sure that the account is in "connected" status, refresh the screen, confirm that "Vote" buttons are enabled now, click on "Vote" button against the Bike model "MT 15"	32
11) Select the "Vote3-Acct" in Metamask, make sure that the account is in "connected" status, refresh the screen, confirm that "Vote" buttons are enabled now, click on "Vote" button against the Bike model "RAY ZR"	34
12) Select the "Vote4-Acct" in Metamask, make sure that the account is in "connected" status, refresh the screen, confirm that "Vote" buttons are enabled now, click on "Vote" button against the Bike model "FZ X"	36
13) Select "Admi-Acct", make sure that the account is in "connected" status, refresh the page, click on "ADMIN" and click on "eVoting End" button as an Admin	38
14) Click on "Results" link and verify the eVoting Results	38
	39



## I) Project Goal (Problem Statement)

To design, develop and verify the "eVoting for Bike Application" having the following features:

- a) Display the front-end of the Application on the default Browser
- b) Setup the "Admin" related info and start the eVoting process
- c) Add 3 bikes for eVoting
- d) Register 4 Voters
- e) As an "Admin" approve all the 4 Voters
- f) Perform eVoting for Bikes using 4 Voters account
- g) As an "Admin" close the eVoting Process
- h) Verify the result of eVoting

## II) Solution Proposed

We will design, develop, implement and verify the Ethereum Blockchain based solution namely "eVoting for Bikes Application" which will be executed in a Windows System. The proposed Solution will meet all the features specified in the Problem statement

## III) Input Data

SL.NO	BIKE MODEL	MODEL YEAR
1	RIS V4	2023
2	MT 15	2020
3	ZAY ZR	2019

## IV) Project/ Solution (eVoting for Bikes Application) Design

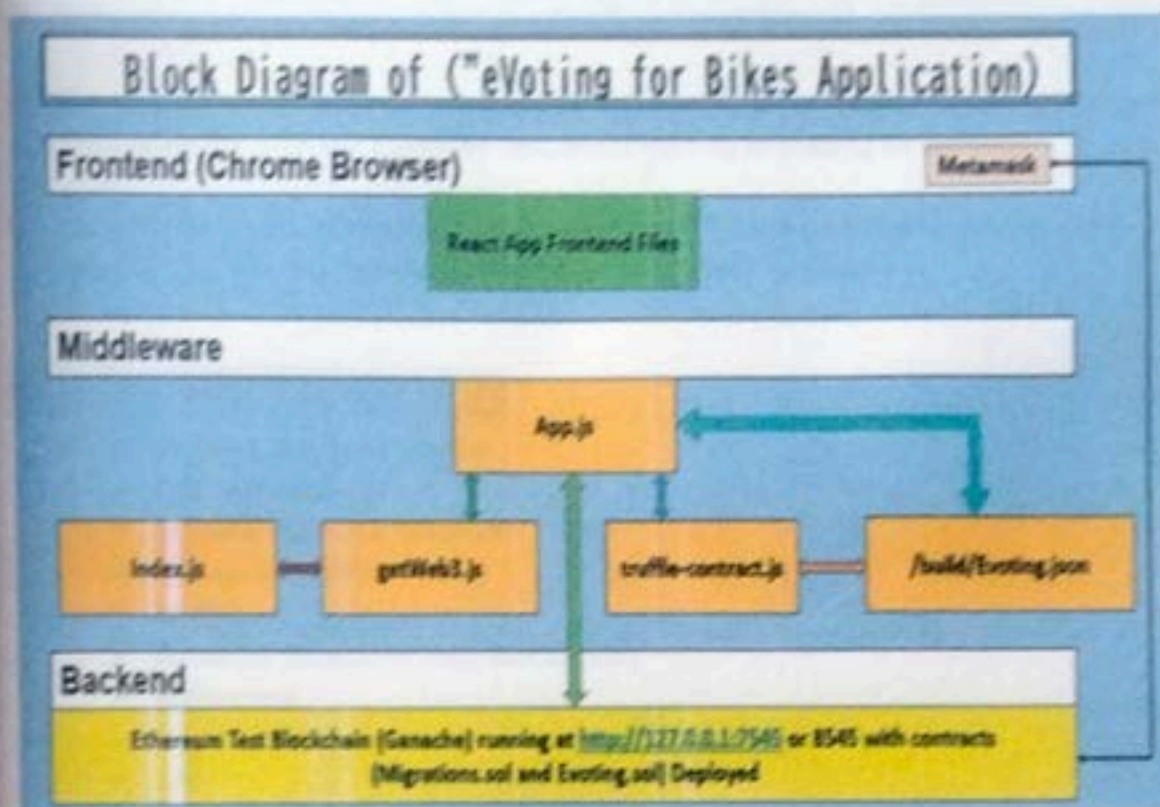

### High Level:

- 1) Create / provide the following in the Windows System:
  - a) Create and set the Ethereum Blockchain environment in the Windows system
  - b) Create the Project folders and files using "Truffle" in the Windows System
  - c) Write the Solidity program "Evoting.sol" capturing the main logic of the solution
  - d) Write the required frontend, middleware and other required files for the solution
  - e) Provide the Solution data using .JSON file

### Details:

- a) Set-up the Ethereum Blockchain environment in the Windows System by installing NodeJS, NPM, Truffle, Ganache and Metamask
- b) By using Truffle, setup the project folder and required files in the Windows System.
- c) Write a Solidity language program namely "Evoting.sol" in which we will implement the main logic of the Solution.



- d) Write the middleware program using JavaScript and Web3.js
- e) Start the Ethereum Test Blockchain "Ganache" and sign-in to the Metamask. Connect the Metamask with the Ganache Test Blockchain by importing an account
- f) We will also create a frontend (React App based) for the solution so that you can interact with the Blockchain application through your browser.

## V) Tools/ Technologies Used

- a) List of Tools and Technologies
  - O/S: Windows 10
  - Browser: Chrome Browser
  - Nodejs and NPM
  - Truffle
  - Ganache (Ethereum Test Blockchain)
  - Metamask
  - HTML
  - CSS
  - JavaScript
  - Web3.js
  - Front-end Tools:
    - HTML, CSS
    - Development Server (lite-server)
- b) Backend:
  - Ethereum based Test Blockchain linked with Metamask
- c) Middleware:
  - JavaScript with Web3.js

## VI) Install the Tools required for the Ethereum Based Blockchain Project in Windows System

(For the detailed instructions, please refer "Appendix-A" document of this Project Report)

## VII) Setup the Ethereum Blockchain based Project "eVoting for Books Application" in the Windows System

(For the detailed instructions, please refer "Appendix-B" document of this Project Report)



॥ ಶ್ರದ್ಧಾಹಿ ಪರಮಾ ಗತಿಃ ॥

**THE NATIONAL COLLEGE**  
Autonomous  
Jayanagar, Bangalore-560070

**Project Report on**  
**Ethereum Blockchain based**  
**eVoting for PhD Approval**

**BY**

**Vamsi M**

**20NCJB451**

**Under the guidance of**

**Prof Varadaraj R**



*Dr. Sridhar*  
PRINCIPAL  
The National College  
Jayanagar, Bangalore-70.

**eVoting PhD Approval project report submitted in partial fulfilment of the**  
**requirements of**

**VI Semester BCA, THE NATIONAL COLLEGE JAYANAGAR**





॥ ಶ್ರದ್ಧಾಹಿ ಪರಮಾ ಗತಿಃ ॥



**THE NATIONAL COLLEGE**  
Autonomous  
Jayanagar, Bangalore-560070

### CERTIFICATE

This is to certify the project report titled "eVoting for PhD Approval" is a work done by **Vamsi M** of **THE NATIONAL COLLEGE**, Jayanagar, Bengaluru, in partial fulfilment of the requirements of **VI Semester BCA** during the year **2022-2023**.

  
**HEAD OF THE DEPARTMENT**  
Head. Dept. of Comp. Science  
The National Degree College  
(Autonomous)  
Jayanagar, Bangalore - 560 070

Examiners:

1. 
2. 

  
**PROJECT GUIDE**

Examination Centre

National College, Jayanagar

Date of Examination: 22/08/23



  
**PRINCIPAL**  
The National College  
Jayanagar, Bangalore-70.

## ACKNOWLEDGEMENT

**eVoting for PhD Approval** is the project of many hands from the team. Our tribute for the successful completion of the project goes to all those who helped through their constant guidance and encouragement. The satisfaction that accompanies the success would be incomplete without thanking person who made it.

We are thankful to our beloved Principal **Dr. B SURESHA**, who encourages us to come with new and innovative ideas and for providing the environment with all facilities for completing the project.

We are also grateful to our Head of the Department **Prof. ASHA TS** Department of computer science for her valuable guidance and constant support during our project development.

We are also grateful to our project guide **Prof. VARADARAJ R**, lecturer Department of computer science for his valuable guidance and constant support during our project development.

We are also grateful to **MUTHURAM GOVINDARASU** CEO and Founder of Indigeneous Tech Private Limited, Bangalore-32 with 10 years of experience in Blockchain for his valuable guidance and technical support for our project.

We extend our thanks to all our teaching staffs of department of computer science. Finally, we thank one and all who helped us directly and indirectly for the completion of our project.



## Table of Contents

I) Project Goal (Problem Statement)	6
II) Solution Proposed	6
III) Input Data	6
IV) Project Team Members	6
V) Referenced Documents	6
VI) Project/ Solution (eVoting for PhD Approval) Design	7
VII) Tools/ Technologies Used	8
VIII) Install the Tools required for the Ethereum Based Blockchain Project in Windows System	8
IX) Setup the Ethereum Blockchain based Project "eVoting for PhD Approval" in the Windows System	8
X) Project Execution	9
1) Execute "ganache-cli" command. Copy the Ether accounts and Private keys in a Notepad. Connect the Metamask with Ganache by importing one of its accounts	9
2) Sign-in to the Metamask, select the network "Localhost 8545", import the first account of the Ganache Blockchain and make sure that the account is in "connected" state	10
3) Compile and deploy the smart contract on to Ethereum Test Blockchain on to Ganache using Ether through Metamask	13
4) Click on "ADMIN" option and fill-in the relevant info under "About Admin", "About eVoting" and click on "Start eVoting" button. Click on the "Confirm" button of the Metamask. Verify that the eVoting process got started	15
5) Click on "Add PhD Topic" option and fill-in the info related to the PhD Topic for which you need eVoting. Add 3 PhD Topics for eVoting	17
6) Click on "Registration" and register 4 Voters	19
7) Select the "Admin-Acct" in Metamask, refresh the screen, click on "Verification" link and as an Admin approve all the 4 Voters	30
8) Click on "Voting" link and check the PhD Topics Info displayed	36
9) Select the "Vote1-Acct" in Metamask, make sure that the account is in "connected" status, refresh the screen, confirm that "Vote" buttons are enabled now, click on "Vote" button against the Book titled "Neural network"	36
10) Select the "Vote2-Acct" in Metamask, make sure that the account is in "connected" status, refresh the screen, confirm that "Vote" buttons are enabled now, click on "Vote" button against the Book titled "Pattern recognition"	39
11) Select the "Vote3-Acct" in Metamask, make sure that the account is in "connected" status, refresh the screen, confirm that "Vote" buttons are enabled now, click on "Vote" button against the Book titled "Robotics"	41

12) Select the "Vote4-Acct" in Metamask, make sure that the account is in "connected" status, refresh the screen, confirm that "Vote" buttons are enabled now, click on "Vote" button against the Book titled "Neural network".....43

13) Select "Admi-Acct", make sure that the account is in "connected" status, refresh the page, click on "ADMIN" and click on "eVoting End" button as an Admin.....45

14) Click on "PhD Approval Status" link and verify the eVoting Results.....48

XI) Project Summary .....48



## I) Project Goal (Problem Statement)

To design, develop and verify the "eVoting for PhD Approval" having the following features:

- a) Display the front-end of the Application on the default Browser
- b) Setup the "Admin" related info and start the eVoting process
- c) Add 3 PhD Topics for eVoting
- d) Register 4 Voters
- e) As an "Admin" approve all the 4 Voters
- f) Perform eVoting for PhD Topics using 4 Voters account
- g) As an "Admin" close the eVoting Process
- h) Verify the result of eVoting

## II) Solution Proposed

We will design, develop, implement and verify the Ethereum Blockchain based solution namely "eVoting for PhD Approval" which will be executed in a Windows System. The proposed Solution will meet all the features specified in the Problem statement

## III) Input Data

Sl. No	PhD Topics	Student Name
1	Neural networks	Iswar
2	Pattern recognition	Kumar
3	Robotics	Rajesh

## IV) Project Team Members

- 1) Bharath B
- 2) Jahnvi M
- 3) Vamsi M

## V) Referenced Documents:

- 1) Appendix-A: 02-Appendix-A-Install-and-Setup-Metmask-Ganache-Nodejs-Truffle-VisualStudioCode-in-Windows-Platform-12-Sep-2022.docx
- 2) Appendix-B: 03-Appendix-B-Ethereum-Project-eVoting-for-PhD Approval-Setup-12-Sep-2022.docx
- 3) Appendix-C: 04-Appendix-C-Programs-and-Files-Used-in-eVoting-for-PhD Approval - 12-Sep-2022.docx

## Kenpath Technologies Pvt. Ltd

---

Date: 14/08/2023

### Internship Certificate

*To whom it may concern*

This is to certify that **Anand V** has completed an internship with us in the data science department from 23rd March 2023 to 31st July 2023.

Anand proactively took on tasks, worked diligently on the tasks assigned to him, and completed them on time. Anand showed great inquisitiveness, consistently delved into new technologies, and demonstrated both skill and initiative.

We believe Anand has a great future ahead of him, and we highly recommend Anand V for future data science opportunities.

Sincerely,



Aditya Chhabra  
Data Science Manager,  
Kenpath Technologies Pvt. Ltd

---

Kenpath Technologies Pvt. Ltd



## Kenpath Technologies Pvt. Ltd

---

Date: 14/08/2023

### Internship Certificate

*To whom it may concern*

This is to certify that **Anand V** has completed an internship with us in the data science department from 23rd March 2023 to 31st July 2023.

Anand proactively took on tasks, worked diligently on the tasks assigned to him, and completed them on time. Anand showed great inquisitiveness, consistently delved into new technologies, and demonstrated both skill and initiative.

We believe Anand has a great future ahead of him, and we highly recommend Anand V for future data science opportunities.

Sincerely,

*Aditya Chhabra*

Aditya Chhabra  
Data Science Manager,  
Kenpath Technologies Pvt. Ltd



*S. Sush*  
PRINCIPAL  
The National College  
Jayanagar, Bangalore-70.

---

Kenpath Technologies Pvt. Ltd

Regd. office: A 107, Lotus Palace, Kasavanahalli, Off Sarjapur road, Bengaluru, Karnataka-35,  
PAN No: AAFCI7750R | CIN No: U72900KA2020PTC137843 | GSTIN: 29 AAFCI7750R1ZN  
E-mail: [info@kenpath.io](mailto:info@kenpath.io) | website: [www.kenpath.io](http://www.kenpath.io)



## Certificate of Internship

This is to certify

**Ananta Raja**

---

of **National College**

Has successfully started an internship of 3 months on project **Maven**  
from 3<sup>rd</sup> April 2023 with **Datazymes Analytics Private Limited**



Authorized Signatory  
**Amith Mohandas**



*To. Sush*  
PRINCIPAL  
The National College  
Jayanagar, Bangalore-70.



TechnoFly Solutions



Internship Certificate

This is to certify that ANIL KUMAR V. S a student of THE NATIONAL COLLEGE, JAYANAGAR has completed 3 months/weeks of Internship From 15 - 05 - 2023 To 15 - 08 - 2023 in MACHINE LEARNING Domain.

We wish you all the best in your future endeavors.

Date : 15 - 08 - 2023

For TechnoFly Solutions



Technofly Solutions, Vijayanagar, Bangalore - 40.  
Mob.: 9663476586, 9741150102 | www.technofly.in



*[Signature]*  
PRINCIPAL  
The National College  
Jayanagar, Bangalore-70.

TechnoFly Solutions



Internship Certificate

This is to certify that ASHITH SAGAR NAIDU a student of THE NATIONAL COLLEGE, JAYANAGAR has completed 3 <sup>✓</sup> months/weeks of Internship From 15-05-2023 To 15-08-2023 in MACHINE LEARNING Domain.

We wish you all the best in your future endeavors.

Date : 15-08-2023

For TechnoFly Solutions



Technofly Solutions, Vijayanagar, Bangalore - 40.  
Mob.: 9663476586, 9741150102 | www.technofly.in



*[Signature]*  
PRINCIPAL  
The National College  
Jayanagar, Bangalore-70



# Calaver Technologies Pvt.Ltd



March 28, 2023

Dear Chandan,

On behalf of Calaver Technologies Private Limited ("Scispace"), I am pleased to offer you the position of **Data Mining Intern** in our company. We are confident that you would play a significant role in the overall success of the venture and wish you the most enjoyable, learning-packed, and truly *meaningful* internship experience with Calaver.

Your appointment will be governed by the terms and conditions presented in **Annexure A**.

## COMPENSATION

Calaver will deduct taxes at the source as required by law. You will be responsible for your tax liabilities under applicable tax laws and regulations. Your CTC opportunity is **Rs. 25000 per month**.

Calaver reserves the right to vary, amend and modify any item of the salary package without adversely affecting the total compensation. Compensation is regarded as confidential information and should not be disclosed to other employees. Your position at Calaver is a professional position that requires a significant level of responsibility, discretion, and independent judgment. In view of your position and office, you must effectively, diligently and to the best of your ability perform all responsibilities and ensure good results.

**Duration: 3 Months**

OFFER OF EMPLOYMENT

  
PRINCIPAL  
The National College  
Jayanagar, Bangalore-70.



The purpose of this Invitation of Employment is to put in writing the specifics of our offer of employment to commence work with Calaver **on or before 30th March, 2023**.

Please acknowledge and sign this Invitation of Employment and return it to us by sending a scanned copy via email to [monali@typeset.io](mailto:monali@typeset.io) & [pratik@typeset.io](mailto:pratik@typeset.io). We must receive your decision to accept this Invitation of Employment by **March 29th, 2023** after which date, this offer will expire. If you need more

Level 8, Tower 1, Umiya Business Bay Cessna Business Park, Kadubeesanahalli,  
Marathahalli, Bangalore - 560 103, Karnataka, India.

Landline Number: +91 8067 577 889 | Fax Number: +91 8067 577 898

# Calaver Technologies Pvt.Ltd

time to consider your options, simply let us know, and we can decide upon a mutually acceptable date within which you could confirm your acceptance of this Invitation to Employment.

We look forward to welcoming you to Calaver.

Sincerely,  
Saikiran  
ACCEPTANCE

*Saikiran*



By signing this Invitation of Employment and reviewing the sample Employment Agreement, you agree to and accept the terms and conditions of employment with Calaver. You will receive an official copy of the Employment Agreement with your new hire paperwork, which must be signed on or before your first day with Calaver.

Signature: \_\_\_\_\_

Today's Date: \_\_\_\_\_

## **Annexure A**

You shall be governed by the following terms and conditions of service during your internship with Calaver, and those may be amended from time to time.

1. You will be working on-site (in our HSR, Bangalore Office) for the duration of the internship. There will be catch-ups scheduled with your mentor to discuss work progress and overall internship experience at regular intervals.
2. All the work that you will produce at or in relation to Calaver will be the intellectual property of Calaver. You are not allowed to store, copy, sell, share, and distribute it to a third party under any circumstances. Similarly, you are expected to refrain from talking about your work in public domains (both online such as blogging, social networking sites, and offline among your friends, college, etc.) without prior discussion and approval with your mentor.
3. We take data privacy and security very seriously and maintaining the confidentiality of any students, customers, clients, and companies' data and contact details that you may get access to during your internship will be your responsibility. Calaver operates on a zero-tolerance principle with regard to any



# Calaver Technologies Pvt.Ltd

breach of data security guidelines. At the completion of the internship, you are expected to hand over all Calaver work/data stored on your Personal Computer to your mentor and delete the same from your machine.

4. During the appointment period, you shall not engage yourselves directly or indirectly or in any capacity in any other organization (other than your college). In the event of a breach of this condition, this appointment is liable to be terminated forthwith by the company.

5. Under normal circumstances, either the company or you may terminate this association by providing a notice of 30 days without assigning any reason. However, the company may terminate this agreement forthwith under situations of in-disciplinary behaviors.

6. Calaver is a start-up and we love people who like to go beyond the normal call of duty and can think out of the box. Surprise us with your passion, intelligence, creativity, and hard work – and expect appreciation & rewards to follow.

7. Expect constant and continuous objective feedback from your mentor and other team members and we encourage you to ask for and provide feedback at every possible opportunity. It's your right to receive and give feedback – this is the ONLY way we all can continuously push ourselves to do better.

8. Have fun at what you do and do the right thing – both the principles are the core of what Calaver stands for and we expect you to imbibe them in your day-to-day actions and continuously challenge us if we are falling short of expectations on either of them.

9. You will be provided ₹25,000 per month as a stipend. All the office-related expenses (phone calls, internet, etc., if any) would be reimbursed on an actual basis.



Government of India  
Ministry of Education



# Internship Completion Certificate

This certificate is proudly awarded to

**CHANDANA S**

In recognition for his/her effort resulting in such great performance  
Chandana S Given this award at(06/07/2023)

  
PRINCIPAL  
The National College,  
Jayanagar, Bangalore-70.



  
Jeevanandham S  
CEO





Government of India  
Ministry of Education



# Internship Completion Certificate

This certificate is proudly awarded to

**DEEKSHA N**

In recognition for his/her effort resulting in such great performance  
Deeksha N Given this award at(06/07/2023)

  
PRINCIPAL  
The National College  
Jayanagar, Bangalore-70.



  
Jeevanandham S  
CEO

August 11, 2023

**INTERNSHIP CONFIRMATION**

This is to certify that **Mr. Girish E** is doing his **Internship at Anvizent Analytics PVT.LTD** from **11<sup>th</sup> May 2023** in the vertical given below.

**Vertical: Data Engineering**

Yours sincerely,  
For **Anvizent Analytics**



**Lakshmi Sagar Ponnamp**  
**Director**



  
PRINCIPAL  
The National College  
Jayanagar, Bangalore-70.





Government of India  
Ministry of Education



# Internship Completion Certificate

This certificate is proudly awarded to

**KEERTANA L PRAKASH**

In recognition for his/her effort resulting in such great performance  
Keertana L Prakash Given this award at(06/06/2023)

  
PRINCIPAL  
The National College  
Jayanagar, Bangalore-70.



  
Jeevanandham S  
CEO

# Kenpath Technologies Pvt. Ltd.

09<sup>th</sup> May 2023

Bengaluru, India

Sub: Internship offer

Dear Mahesh Babu L C,

On behalf of Kenpath Technologies Pvt. Ltd, I am excited to extend an offer to you for an internship position within our software development department. This position is in Bengaluru, India. The position is for the role of software developer intern.

This position is scheduled to begin on May 10<sup>th</sup>, 2023 and will be a six-month internship opportunity ending on Nov 09<sup>th</sup>, 2023. The schedule for this position is Monday-Friday from 9 a.m. to 6:00 p.m. IST. As a temporary employee in the role of an intern. In this role, you will be allocated mentors to whom you will be reporting your work.

During your temporary employment with Kenpath Technologies Pvt. Ltd, you may have access to trade secrets and confidential or proprietary business information belonging to the company. By accepting this offer, you acknowledge that this information must remain confidential and agree to refrain from using it for your own purposes or disclosing it to anyone outside of Kenpath technologies pvt. ltd. Also, you agree that upon completion of your internship, you will promptly return any company-issued property and equipment along with information and documents belonging to the company. By accepting this offer, you acknowledge that you

Kenpath Technologies Pvt. Ltd

Regd. office: A 107, Lotus Palace, Kasavanahalli, Off Sarjapur road, Bengaluru, Karnataka-35,

PAN No: AAFCI7750R | CIN No: U72900KA2020PTC137843 | GSTIN: 29 AAFCI7750R1ZN

E-mail: [info@kenpath.io](mailto:info@kenpath.io) | website: [www.kenpath.io](http://www.kenpath.io)

  
PRINCIPAL  
The National College  
Jayanagar, Bangalore-70.





understand participation in this program is not an offer of employment, and successful completion of the program does not entitle you to an employment offer from Kenpath Technologies Pvt. Ltd.

We look forward to having you begin your working career at Kenpath Technologies Pvt. Ltd. and wish you a successful internship. Welcome to our team!

Best Wishes,

Sapna Jillella,  
Director  
Kenpath Technologies Pvt. Ltd.

  
PRINCIPAL  
The National College  
Jayanagar, Bangalore-70.



# Annexure:

## About Kenpath

Kenpath is a software product engineering and services organization.

As a technology partner, we are working with organizations to build internet scale technology platforms. We connect strategy, architecture, and execution, helping our clients to strengthen their digital initiatives at scale, with entrepreneurial mindset and agility. We partner with our clients to continuously evolve their tech with the flexibility of architecting and developing solutions that work at scale as well as scale what works, to meet their business goals.

Kenpath is on a mission to democratize access to top class technology. To realize this mission, we have had built products in EdTech and Healthcare sectors. We strongly believe that access to affordable and quality technology will transform millions of small and medium scale businesses in India and across the globe and we are determined to make it a reality through our products.

Our clients are well known brands in the development and corporate sector. As a digital partner to our clients, we are working towards solving complex societal challenges at scale using technology. We are addressing societal challenges such as Water security, Commons, Sustainable livelihood, Education and Healthcare. The technology platform we developed has been used by users across three continents: Asia, North America, and Africa.

---

### Kenpath Technologies Pvt. Ltd

Regd. office: A 107, Lotus Palace, Kasavanahalli, Off Sarjapur road, Bengaluru, Karnataka-35,  
PAN No: AAFCI7750R | CIN No: U72900KA2020PTC137843 | GSTIN: 29 AAFCI7750R1ZN  
E-mail: [info@kenpath.io](mailto:info@kenpath.io) | website: [www.kenpath.io](http://www.kenpath.io)



More details are here: <https://kenpath.io/>



# Gustovalley Technovations

## CERTIFICATE OF COMPLETION

This Certifies that

**MEGHANA M**

has successfully completed 'Gustovalley Technovations' Internship  
Training on Data Science  
which was conducted from 05-05-2023 to 05-08-2023.

The Performance delivered during the program was Good

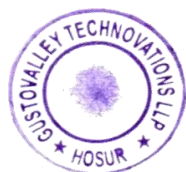

*D. Sudh*  
PRINCIPAL  
The National College  
Jayanagar, Bangalore-70.

*A. May*

Authorized Signatory



Certificate No. : GL5225



## Internship Certificate

This is to certify that **Nithish G** has successfully completed an Internship at **Deepnet Labs Pvt. Ltd.** in the field of Artificial Intelligence and Machine Learning (AI & ML). The internship was carried out with utmost dedication and commitment from 4<sup>th</sup> May 2023 for the duration of 3 months.

During his tenure, Nithish G actively participated in cutting-edge AI and ML projects. He was entrusted with crucial responsibilities and worked on various aspects of the AI and ML development process, ranging from data collection and preprocessing to model training and evaluation. His contribution significantly enhanced the efficiency and accuracy of our AI systems.

Nithish G has proven to be an exceptional intern, displaying remarkable diligence and self-drive in every task assigned to him. He demonstrated a profound understanding of AI and ML concepts and showcased a passion for exploring new advancements in the field. His ability to take initiative and self-learn allowed him to surpass expectations and consistently deliver outstanding results.

Throughout his internship, Nithish G exhibited excellent problem-solving skills and a keen eye for detail, making him a valuable asset to our team. He effectively collaborated with his peers, demonstrating strong communication and teamwork skills. Nithish G's positive attitude and willingness to take on challenges earned him the respect of his colleagues and supervisors alike.

As Nithish G completes his internship with Deepnet Labs, we extend our warmest wishes for his future endeavors. We are confident that his dedication, talent, and passion for AI and ML will continue to drive him towards remarkable achievements in his career.

Congratulations, Nithish G, on successfully completing your internship with Deepnet Labs Pvt. Ltd.!

Best Regards,

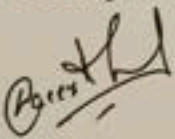

Waez Ahmed Ameer  
Director



Deepnet Labs Private Limited

Deepnet Labs Private Limited

#731, 6th B Cross Rd, Koramangala 3 Block, Koramangala, Bengaluru, Karnataka 560034  
Tel: +91 8951938540 | www.deepnetlabs.com | CIN # U72900KA2023PL158024



  
PRINCIPAL  
The National College  
Jayanagar, Bangalore-70

## Kenpath Technologies Pvt. Ltd

---

Date: 11/08/2023

### Internship Certificate

*To whom it may concern*

This is to certify that **Rohit BC** has completed an internship with us in the data science department from 23rd March 2023 to 31st July 2023.

Throughout his tenure, Rohit showcased an exceptional ability to grasp and apply new technologies rapidly. His intrinsic motivation was evident in the manner he sought out and immersed himself in cutting-edge data science tools and methodologies. This drive was further exemplified by his proactive approach to initiating and completing projects with minimal supervision. Whether it was in a collaborative setting or an individual project, Rohit demonstrated commitment, creativity, and an exemplary level of autonomy.

Given Rohit's zeal for technological exploration and his ability to drive projects to fruition independently, we wholeheartedly believe he will make significant contributions to the field of data science. We enthusiastically recommend him for any future roles or challenges.

Sincerely,



Aditya Chhabra  
Data Science Manager,  
Kenpath Technologies Pvt. Ltd



PRINCIPAL  
The National College  
Jayanagar, Bangalore-70.

---

Kenpath Technologies Pvt. Ltd



## Kenpath Technologies Pvt. Ltd

---

Date: 14/08/2023

### Internship Certificate

*To whom it may concern*

This is to certify that **Shashank A** has completed an internship with us in the data science department from 23rd March 2023 to 31st July 2023.

He was consistent in his contributions and worked well within the assigned tasks. We wish Shashank A the best in his future endeavours.

Sincerely,



Aditya Chhabra  
Data Science Manager,  
Kenpath Technologies Pvt. Ltd



PRINCIPAL  
The National College  
Jayanagar, Bangalore-70.



---

Kenpath Technologies Pvt. Ltd



## Certificate of Internship

This is to certify

**Vinod V**

---

of **National College**

Has successfully started an internship of 3 months on project **Maven**  
from 3<sup>rd</sup> April 2023 with **Datazymes Analytics Private Limited**



Authorized Signatory  
**Amith Mohandas**

  
PRINCIPAL  
**The National College**  
Jayanagar, Bangalore-70.





## Kenpath Technologies Pvt. Ltd

---

Date: 11/08/2023

### Internship Certificate

*To whom it may concern*

This is to certify that **Smrithi Shaji** has completed an internship with us in the data science department from 23rd March 2023 to 31st July 2023.

Throughout her tenure, Smrithi proved herself to be an invaluable asset to our team. She took active part in a variety of data-science projects, showcasing her adaptability in embracing new technologies.

Smrithi was proactive and inquisitive in learning about our current systems and future possibilities. Her dedication to her tasks and commitment to continuous learning stood out prominently. Her consistent efforts make her an exemplary data scientist in the making.

We at Kenpath Technologies were very pleased to work with such a promising individual. We have no doubt that Smrithi Shaji will excel in any future endeavors she chooses to pursue, and we wholeheartedly recommend her for any forthcoming professional opportunities.

Sincerely,



Aditya Chhabra  
Data Science Manager,  
Kenpath Technologies Pvt. Ltd

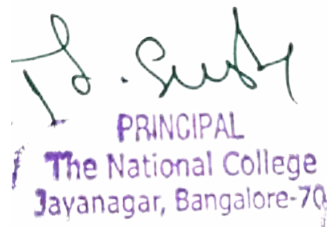

PRINCIPAL  
The National College  
Jayanagar, Bangalore-70.



---

Kenpath Technologies Pvt. Ltd



**THE SPARKS FOUNDATION**  
INSPIRE, INNOVATE, INTEGRATE

## CERTIFICATE OF COMPLETION

*This Certificate is presented to*

*Srinidhi NA*

*for an outstanding contribution during the session (Dec 2022 - Feb 2023) of  
Graduate Rotational Internship Program at The Sparks Foundation on 25-Feb-2023.*



Certificate Number: 68MY759VNI

Verification at: <https://trustsolutions.com/verify/certificate/>

*S. Sush*  
PRINCIPAL  
The National College  
Jaynagar, Bangalore-70



*Pranav D*  
PRANAV DUBEY

MANAGING DIRECTOR





## Internship Completion Letter

05 Dec 2022

To Whomsoever It May Concern

This is to certify that Mr. Supreeth from National college Jayanagar has completed his internship at Jio Platforms Ltd from **26 Sep 2022 to 26 Nov 2022**.

During this period, **Mr. Supreeth** completed a project titled "JDSP" under the guidance of **Mr. Manish verma**.

Please note, as the project involves highly sensitive data, all the details and the contents made towards the project needs to be kept confidential. Under no circumstances must this be shared nor distributed in any form to anyone other than the company-authorized personnel or law requires as. It is expected that Mr. Supreeth complies and adheres to the company policy and its rules.

During the internship period, we found Mr. Supreeth to be sincere and diligent. We wish him all the best in all his future endeavors.

Yours sincerely,  
For Jio Platforms Limited,

Authorized Signatory

PRINCIPAL  
The National College  
Jayanagar, Bangalore-70.





॥ प्रज्ञा हि मरुता गमि ॥

# THE NATIONAL COLLEGE

Autonomous

Jayanagar, Bangalore-560070

## DEPARTMENT OF ELECTRONICS

### CERTIFICATE

This is to certify the project report titled "**HEALTH MONITORING SYSTEM**" is a bonafide record of work done by **GOMATH KUMAR L [20NCJS224]** and **BHARATH R [20NCJS222]** in partial fulfilment of the requirements of the Bachelor of Science from **THE NATIONAL COLLEGE, Jayanagar**, for the academic year **2022-2023**. The project has been approved as it satisfies the academic requirement in the respect of the project work prescribed for the **VI Semester B.Sc.**

.....*M. Mahadevm*.....

Prof .MAHADEVM (MSc, MPhil)  
[ASSOC PROF,

AND INTERNAL GUIDE]

.....*Chelluvapas*.....

Prof.CHELLUVAPAS (MSc)  
[HOD and INTERNAL]

VALUED BY:

<b>VALUED</b>	
Signatures of Examiners	
1)	<i>Chelluvapas</i>
2)	<i>Mahadevm</i>
Date	<i>30-8-2023</i>

NAME:

DATE OF EXAM:



**THE NATIONAL COLLEGE**

Autonomous

Jayanagar, Bangalore-560070

**DEPARTMENT OF ELECTRONICS****CERTIFICATE**

This is to certify the project report titled "**SURVEILLANCE ROBOT ESP32 CAM**" is a Bonafede record of work done by **DEVAMSH.U [20NCJS223]** and **YESHWANTH.R [20NCJS226]** in partial fulfilment of the requirements of the Bachelor of Science from **THE NATIONAL COLLEGE, Jayanagar**, for the academic year 2022-2023. The project has been approved as it satisfies the academic requirement in the respect of the project work prescribed for the 6<sup>th</sup> Semester B.Sc.



Prof .MAHADEV M (MSc, MPhil)  
[ASSOC PROF, and INTERNAL GUIDE ]

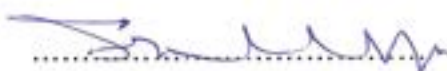

Prof .CHELLUVAPA S (MSc)  
[HOD and INTERNAL]

**VALUED BY:**

<b>VALUED</b>	
Signatures of Examiners	
1)	
2)	
Date	30-8-2022

**NAME****DATE OF EXAM**



|| ಪ್ರಜ್ಞಾ ಪರಮಾಣು ಸಿದ್ಧಿ ||

# THE NATIONAL COLLEGE

Autonomous

Jayanagar, Bangalore-560070

## DEPARTMENT OF ELECTRONICS

### CERTIFICATE

This is to certify the project report titled "**HEALTH MONITORING SYSTEM**" is a bonafide record of work done by **GOMATH KUMAR L [20NCJS224]** and **BHARATH R [20NCJS222]** in partial fulfilment of the requirements of the Bachelor of Science from **THE NATIONAL COLLEGE, Jayanagar**, for the academic year **2022-2023**. The project has been approved as it satisfies the academic requirement in the respect of the project work prescribed for the **VI Semester B.Sc.**

.....*M. Mahadevm*.....

.....*Chelluvapas*.....

Prof .MAHADEVM (MSc, MPhil)  
[ASSOC PROF,

Prof.CHELLUVAPAS (MSc)  
[HOD and INTERNAL]

AND INTERNAL GUIDE]

VALUED BY:

<b>VALUED</b>	
Signatures of Examiners	
1)	<i>Chelluvapas</i>
2)	<i>Mahadevm</i>
Date	<i>30-8-2023</i>

NAME:

DATE OF EXAM:



# THE NATIONAL COLLEGE

Autonomous Jayanagar,  
Bangalore-560070

## DEPARTMENT OF ELECTRONICS

### CERTIFICATE

This is to certify the project report titled "*IOT-BASED AIR POLLUTION MONITORING SYSTEM*" is a bonafide record of work done by *SRIKANTH N* [20NCJS225] and *SHARAN K* [20NCJS227] in partial fulfillment of the requirements of the Bachelor of Science from **THE NATIONAL COLLEGE, Jayanagar**, for the academic year 2022-2023. The project has been approved as it satisfies the academic requirement in the respect of the project work prescribed for the 6<sup>th</sup> Semester B.Sc.

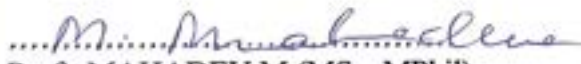
  
Prof. MAHADEV M (MSc, MPhil)  
[ASSOC PROF, and INTERNAL GUIDE ]

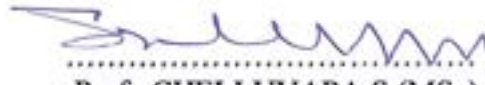
  
Prof. CHELLUVAPA S (MSc)  
[HOD and INTERNAL]

VALUED BY:

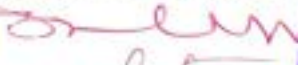
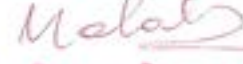
<b>VALUED</b>	
Signatures of Examiners	
1)	
2)	
Date	30-8-2023

NAME:

DATE OF EXAM:

**THE NATIONAL COLLEGE**

Autonomous

Jayanagar, Bangalore-560070

**DEPARTMENT OF ELECTRONICS****CERTIFICATE**

This is to certify the project report titled "**SURVEILLANCE ROBOT ESP32 CAM**" is a Bonafede record of work done by **DEVAMSH.U** [20NCJS223] and **YESHWANTH.R** [20NCJS226] in partial fulfilment of the requirements of the Bachelor of Science from **THE NATIONAL COLLEGE, Jayanagar**, for the academic year 2022-2023. The project has been approved as it satisfies the academic requirement in the respect of the project work prescribed for the 6<sup>th</sup> Semester B.Sc.



Prof .MAHADEV M (MSc, MPhil)  
[ASSOC PROF, and INTERNAL GUIDE ]



Prof .CHELLUVAPA S (MSc)  
[HOD and INTERNAL]

**VALUED BY:**

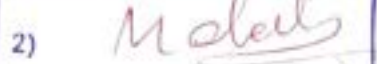
<b>VALUED</b>	
Signatures of Examiners	
1)	
2)	
Date	30-8-2022

**NAME****DATE OF EXAM**



# THE NATIONAL COLLEGE

Autonomous Jayanagar,  
Bangalore-560070

## DEPARTMENT OF ELECTRONICS



### CERTIFICATE

This is to certify the project report titled "*IOT-BASED AIR POLLUTION MONITORING SYSTEM*" is a bonafide record of work done by *SRIKANTH N [20NCJS225]* and *SHARAN K [20NCJS227]* in partial fulfillment of the requirements of the Bachelor of Science from THE NATIONAL COLLEGE, Jayanagar, for the academic year 2022-2023. The project has been approved as it satisfies the academic requirement in the respect of the project work prescribed for the 6<sup>th</sup> Semester B.Sc.

  
Prof. MAHADEV M (MSc, MPhil)  
[ASSOC PROF, and INTERNAL GUIDE ]

  
Prof. CHELLUVAPA S (MSc)  
[HOD and INTERNAL]

VALUED BY:

<b>VALUED</b>	
Signatures of Examiners	
1)	
2)	
Date	30-8-2023

NAME:

DATE OF EXAM:

# THE NATIONAL COLLEGE

Autonomous

Jayanagar, Bangalore-560070

## DEPARTMENT OF ELECTRONICS

### CERTIFICATE

This is to certify the project report titled "*SMART PARKING SYSYTEM*" is a bonafide record of work done by *PADMANABHA N KATTI* [20NCJS214], *KARNA R* [20NCJS228] & *RAMYASHREE G* [16NCJS239] in partial fulfilment of the requirements of the Bachelor of Science from THE NATIONAL COLLEGE, Jayanagar, for the academic year 2022-2023. The project has been approved as it satisfies the academic requirement in the respect of the project work prescribed for the 6th Semester B.Sc.



PROF.CHELLUVAPA S  
[HOD & INTERNAL GUIDE]



PROF.MAHADEV M  
[ASSOC PROF, INTERNAL]

VALUED BY:

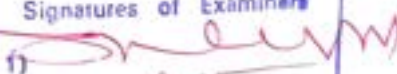
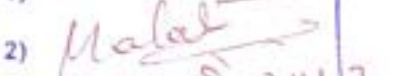
VALUED	
Signatures of Examiners	
1)	
2)	
Date	30-8-2023

Name:

Date of Exam:





|| ಶ್ರವ್ಯಾಹಿ ವರದಮಾ ಗತಃ ||

# THE NATIONAL COLLEGE

Autonomous

Jayanagar, Bangalore-560070

## DEPARTMENT OF ELECTRONICS

### CERTIFICATE

This is to certify the project report titled "**Smart Door System**" is a bonafede record of work done by **Mary Prerana.A [20NCJS229]** and **Vedavidhya [20NCJS215]** in partial fulfilment of the requirements of the Bachelor of Science from THE NATIONAL COLLEGE, Jayanagar, for the academic year 2023-2024. The project has been approved as it satisfies the academic requirement in the respect of the project work prescribed for the VI Semester B.Sc.

.....*M. Mahadev*.....

.....*Chelluvapa S*.....

Prof .MAHADEV M (MSc, MPhil)

Prof .CHELLUVAPA S (MSc)

[ASSOC PROF,

[HOD and INTERNAL]

AND INTERNAL GUIDE]

VALUED

Signatures of Examiners

VALUED BY:

1) *Chelluvapa S*

2) *Mahadev*

Date

*30-8-23*

NAME:

DATE OF EXAM:

Name: Pallavi V

Dear Pallavi,

Thank you for seeking and fulfilling an election-specific five-day internship with NDTV for coverage of the Karnataka Assembly Elections 2023.

We wish you the very best for your future.

Best Wishes,



**Anuradha Srinivasan**  
**Head-HR NDTV Group**





Abhiram J &lt;abhiram@ncjayanagar.com&gt;

---

**Project dissertation Grade and Invitation for Project Presentation event**

7 messages

---

**MOHAN A** <mohan@sjc.ac.in>  
To: abhiram@ncjayanagar.com

Mon, Jul 18, 2022 at 1:37 PM

Dear Professor

It is with great pleasure that I inform you that the Semester IV at St. Joseph's (Autonomous) College, PG Section will be coming to a completion shortly. You've been an important part of our activities by guiding our students with their project for nearly a year's time. I take this opportunity to thank you for the help you have extended to St. Joseph's and appreciate all the kindness that you've shown us.

As you were the supervisor to **Deepak Raja S (20PHY04)** and **Mathew J Mathews (20PHY15)** project, we will require one more help from you in the form of grading them.

The total grade is for 100 points of which **50 points** is delegated for internal work and will be graded by **you** (the various heads each carrying 10 points can be: Passion, Hard work/commitment, Understanding/cognition, Communication, Regularity of meeting you/meeting the deadlines you have imposed - these heads are loose and perhaps merge between themselves; please feel free to alter them as you deem fit).

The balance of 50 points will be external and be graded by us at the Department of Physics, St. Joseph's college. These grades will go for their project presentations.

**You are cordially invited to our department for the Project Presentation event.** The event is scheduled for the **4<sup>th</sup> of August 2022, 10:00 am**. The presentations will go on **till 4:00 PM** and refreshments and lunch will be provided.

**Please confirm your presence by 1<sup>st</sup> of August, 2022 midday so we can make arrangements for the food.**

Thanks, and regards

Dr. Mohan. A  
Assistant Professor,  
Department of Physics  
School of Physical Sciences  
St. Joseph's University  
Bengaluru - 560027.

  
PRINCIPAL  
The National College  
Jayanagar, Bangalore-70.



---

**Abhiram J** <abhiram@ncjayanagar.com>  
To: MOHAN A <mohan@sjc.ac.in>

Tue, Aug 2, 2022 at 11:58 PM

Dear Sir,

PHYSICAL AND OPTICAL STUDIES OF VANADIUM PENTOXIDE DOPED  
GLASSES

MSc. dissertation project report in partial fulfilment of the requirements for

the degree of

MASTER OF SCIENCE

IN

PHYSICS

BY

MATHEW J MATHEWS

(Reg No :20PHY15)

St. Joseph's College – Bengaluru



*[Handwritten signature]*

PRINCIPAL

The National College  
Jayanagar, Bangalore-70.



cosupervisor : Mr. Abhiram J



# DISSERTATION PROJECT REPORT

M.Sc Physics – III Sem



## Physical and optical studies of Vanadium Pentoxide doped with Lithium Oxide borate glasses

Research Supervisor:

Dr. R. Rajaramakrishna

Supervisor: Mr. *[Signature]*

PRINCIPAL

The National College  
Jayanagar, Bangalore-70.

BY,

DEEPAK RAJA S,  
(20PHY04)





# The National College (Autonomous)

Jayanagar, Bengaluru – 70

DEPARTMENT OF POST GRADUATE STUDIES AND RESEARCH IN PHYSICS

## CERTIFICATE

This is to certify that the present Project titled "A STUDY ON STRUCTURAL AND MORPHOLOGICAL PROPERTIES OF Li SUBSTITUTED  $MgNaO_3$  NANOPARTICLES FOR ENERGY STORAGE APPLICATIONS" has been the outcome of an original study carried out by **Mr VEERESH P S** under the supervision of **Dr. K T VASUDEVAN** towards the partial fulfilment of the requirements for the degree of Masters of Science in Physics at The National College, Jayanagar, Bangalore.

This is to further certify that the work reported is his independent original investigation and herein does not form a part of any other thesis / dissertation, on the previously forming of which a degree or diploma or a certificate has been conferred upon this or any other student in the past.



**Signature of Project Supervisor**

**Dr.P.NAGARAJU**  
Project supervisor  
Department of Post Graduate Studies &  
Research in Physics  
The National College Jayanagar,  
Bangalore-560070



**Co-Ordinator Signature**

**The Co-ordinator**  
Dept. of PG Studies in Physics  
The National College  
**AUTONOMOUS**  
Jayanagar, Bangalore - 70.

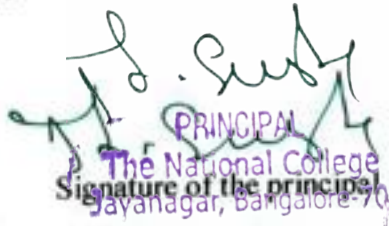

**PRINCIPAL**  
The National College  
Jayanagar, Bangalore-70.



Date: 23 November 2023

Place: Bengaluru



# The National College (Autonomous)

Jayanagar, Bengaluru – 70

DEPARTMENT OF POST GRADUATE STUDIES AND RESEARCH IN PHYSICS

## CERTIFICATE

This is to certify that the present Project titled "SYNTHESIS AND CHARACTERISATION OF CALCIUM ZINC LITHIUM BOROPHOSPHATE GLASSES" has been the outcome of an original study carried out by **Mr SYED KASHIF** under the supervision of **Dr. P NAGARAJU** towards the partial fulfilment of the requirements for the degree of Masters of Science in Physics at The National College, Jayanagar, Bangalore.

This is to further certify that the work reported is his independent original investigation and herein does not form a part of any other thesis / dissertation, on the previously forming of which a degree or diploma or a certificate has been conferred upon this or any other student in the past.



Signature of Project Supervisor

**Dr.P.NAGARAJU**  
Project supervisor  
Department of Post Graduate Studies &  
Research in Physics  
The National College Jayanagar,  
Bangalore-560070



Co-Ordinator Signature  
The Co-ordinator  
Dept. of PG Studies in Physics  
The National College  
AUTONOMOUS  
Jayanagar, Bangalore - 70.



PRINCIPAL  
Signature of the principal  
The National College  
Jayanagar, Bangalore-70.



Date: 23 November 2023

Place: Bengaluru



|| ಪ್ರಧಾನ್ ಪರಮಾ ಗತಿಃ ||

## CERTIFICATE

**Department of Physics and Research,  
The National College, Jayanagar, Bangalore.**

This is to certify that the present Project titled "*Structural and electrical studies on  $V_2O_5$  doped  $B_2O_3-Al_2O_3-TiO_2-SrCO_3$  ceramics*" has been the outcome of an original study carried out by **Swathi S** under the supervision of **Assistant Prof. Reshma K** towards the partial fulfilment of the requirements for the degree of M.Sc. Physics of The National College, Jayanagar, Bangalore.

This is to further certify that the work reported herein does not form a part of any other thesis/dissertation, on the basis of which a degree, diploma or certificate has been conferred upon this or any other student in the past.

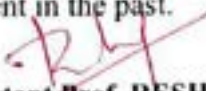
  
**Assistant Prof. RESHMA K**

Project Supervisor

  
Department of Physics and Research  
The National College, Jayanagar, Bangalore  
**PRINCIPAL**  
The National College  
Jayanagar, Bangalore-70.







|| ಶ್ರದ್ಧಾಪಿ ಪರಮಾ ಗತಃ ||

Department of Physics and Research,  
The National College, Jayanagar, Bangalore.

### CERTIFICATE

This is to certify that the present Project titled "*Structural, morphological, optical, dielectric study of transition bimetal oxides prepared by sol-gel combustion method*" has been the outcome of an original study carried out by Sunith R under the supervision of Assistant Prof. Reshma K towards the partial fulfilment of the requirements for the degree of M.Sc. Physics of The National College, Jayanagar, Bangalore.

This is to further certify that the work reported herein does not form a part of any other thesis/dissertation, on the basis of which a degree, diploma or a certificate has been conferred upon this or any other student in the past.

Assistant Prof. Reshma K

Project Supervisor

Department of Physics and Research

The National College, Jayanagar

Bangalore

PRINCIPAL

The National College  
Jayanagar, Bangalore-70.



# The National College (Autonomous)

Jayanagar, Bengaluru – 70

DEPARTMENT OF POST GRADUATE STUDIES AND RESEARCH IN PHYSICS

## CERTIFICATE

This is to certify that the present Project titled "SYNTHESIS OF REDUCED GRAPHENE OXIDE FROM CHICORY MIXED COFFEE POWDER USING SOLID STATE COMBUSTION METHOD" has been the outcome of an original study carried out by Mr. PAVANKALYAN under the supervision of Dr. THEJAS R towards the partial fulfilment of the requirements for the degree of Masters of Science in Physics at The National College, Jayanagar, Bangalore.

This is to further certify that the work reported is his independent original investigation and herein does not form a part of any other thesis / dissertation, on the previously forming of which a degree or diploma or a certificate has been conferred upon this or any other student in the past.

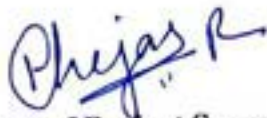

Signature of Project Supervisor

**Dr. THEJAS R**

Assistant Professor

Department of Post Graduate Studies &

Research in Physics

The National College Jayanagar,

Bangalore-560070



Coordinator Signature

**The Co-ordinator**

Dept. of PG Studies in Physics

The National College

**AUTONOMOUS**

Jayanagar, Bangalore - 70.



PRINCIPAL

The National College  
Jayanagar, Bangalore-70.



Signature of the principal

The National College  
Jayanagar, Bangalore-70.



Date: 23/11/2023

Place: Bengaluru



# The National College (Autonomous)

Jayanagar, Bengaluru – 70

DEPARTMENT OF POST GRADUATE STUDIES AND RESEARCH IN PHYSICS

## CERTIFICATE

This is to certify that the present Project titled " A STUDY ON STRUCTURAL AND MORPHOLOGICAL PROPERTIES OF Al DOPED NaLiO<sub>3</sub> NANOPARTICLES FOR ENERGY STORAGE APPLICATIONS" has been the outcome of an original study carried out by **Mr. MOHAN KUMAR G** under the supervision of **Dr. K T VASUDEVAN** towards the partial fulfilment of the requirements for the degree of Masters of Science in Physics at The National College, Jayanagar, Bangalore.

This is to further certify that the work reported is his/her independent original investigation and herein does not form a part of any other thesis / dissertation, on the previously forming of which a degree or diploma or a certificate has been conferred upon this or any other student in the past.

  
Signature of Project Supervisor

**Dr. K T VASUDEVAN**

Co-Ordinator

Department of Post Graduate &  
Research in Physics

The National College Jayanagar-70

  
Co-Ordinator Signature

The Co-ordinator  
Dept. of PG Studies in Physics  
The National College  
Jayanagar, Bangalore - 70.

  
PRINCIPAL  
The National College  
Jayanagar, Bangalore-70.

Signature of the principal



Date: 23 November 2023

Place: Bengaluru



॥ ಶ್ರದ್ಧಾಪಿ ಪರಮಾ ಗತಿಃ ॥

Department of Physics and Research,  
The National College, Jayanagar, Bangalore.

## CERTIFICATE

This is to certify that the present Project titled "*Bio-active investigations of rare earth - doped bimetal oxide nanoparticles to enhance antimicrobial properties*" has been the outcome of an original study carried out by **Keerthana Jayaprakash** under the supervision of **Assistant Prof. Reshma K** towards the partial fulfilment of the requirements for the degree of M.Sc.Physics of The National College, Jayanagar, Bangalore.

This is to further certify that the work reported herein does not form a part of any other thesis/dissertation, on the basis of which a degree, diploma or a certificate has been conferred upon this or any other student in the past.

**Assistant Prof. Reshma K**

  
Project Supervisor

**PRINCIPAL**  
Department of Physics and Research  
The National College  
Jayanagar, Bangalore-70.  
The National College, Jayanagar, Bangalore





# The National College (Autonomous)

Jayanagar, Bengaluru – 70

DEPARTMENT OF POST GRADUATE STUDIES AND RESEARCH IN PHYSICS

## CERTIFICATE

This is to certify that the present Project titled "A STUDY ON STRUCTURAL AND MORPHOLOGICAL PROPERTIES OF Na SUBSTITUTED  $\text{AlCaO}_3$  NANOPARTICLES FOR CATALYSIS APPLICATIONS" has been the outcome of an original study carried out by Mr. DILIP CHANDRA MR under the supervision of Dr. K T VASUDEVAN towards the partial fulfilment of the requirements for the degree of Masters of Science in Physics at The National College, Jayanagar, Bangalore.

This is to further certify that the work reported is his/her independent original investigation and herein does not form a part of any other thesis / dissertation, on the previously forming of which a degree or diploma or a certificate has been conferred upon this or any other student in the past.

  
Signature of Project Supervisor

Dr. K T VASUDEVAN

Co-Ordinator

Department of Post Graduate &

Research in Physics

The National College Jayanagar-560070

  
Co-Ordinator Signature

The Co-ordinator  
Dept. of PG Studies in Physics  
The National College  
AUTONOMOUS  
Jayanagar, Bangalore - 70.



PRINCIPAL  
The National College  
Jayanagar, Bangalore-70  
Signature of the principal



Date: 23 November 2023

Place: Bengaluru

# The National College (Autonomous)

Jayanagar, Bengaluru – 70

DEPARTMENT OF POST GRADUATE STUDIES AND RESEARCH IN PHYSICS

## CERTIFICATE

This is to certify that the present Project titled **“THE EFFECT OF CRYSTAL GROWTH ON PHYSICAL, STRUCTURAL AND RADIATION SHEILDING PROPERTIES OF LEAD VANDOBORATE GLASSY SYSTEM”** has been the outcome of an original study carried out by **Mr DARSHAN A** under the supervision of **Dr. THEJAS R** towards the partial fulfilment of the requirements for the degree of Masters of Science in Physics at The National College, Jayanagar, Bangalore.

This is to further certify that the work reported is his independent original investigation and here in does not form a part of any other thesis on the previously forming of which a degree or diploma or a certificate has been conferred upon this or any other student in the past.

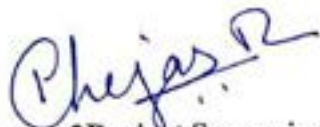

Signature of Project Supervisor

**Dr. THEJAS R**

Assistant Professor

Department of Post Graduate &  
Research in physics

The National College Jaynagar-560070.



The Co-ordinator  
Dept. of PG Studies in Physics  
The National College  
AUTONOMOUS  
Jayanagar, Bangalore - 70.



PRINCIPAL  
The National College  
Jayanagar, Bangalore-70.  
Signature of the principal



Date: 23 November 2023

Place: Bengaluru



# The National College (Autonomous)

Jayanagar, Bengaluru – 70

DEPARTMENT OF POST GRADUATE STUDIES AND RESEARCH IN PHYSICS

## CERTIFICATE

This is to certify that the present Project titled “**STRUCTURAL, PHYSICAL AND OPTICAL PROPERTIES OF LEAD VANDOBORATE GLASSY SYSTEM**” has been the outcome of an original study carried out by **Mr BHARATH Kunder** the supervision of **Dr. THEJAS R** towards the partial fulfilment of the requirements for the degree of Masters of Science in Physics at The National College, Jayanagar, Bangalore.

This is to further certify that the work reported is his independent original investigation and here in does not form a part of any other thesis on the previously forming of which a degree or diploma or a certificate has been conferred upon this or any other student in the past.



Signature of Project Supervisor

**Dr. THEJAS R**

Assistant Professor

Department of Post Graduate &  
Research in physics

The National College Jayanagar-560070



PRINCIPAL  
The National College  
Jayanagar, Bangalore-70.

Signature of the principal



The Co-ordinator  
Dept. of PG Studies in Physics  
The National College  
Autonomous  
Jayanagar, Bangalore - 70.



Date: 23 November 2023

Place: Bengaluru

# The National College (Autonomous)

Jayanagar, Bengaluru – 70

DEPARTMENT OF POST GRADUATE STUDIES AND RESEARCH IN PHYSICS

## CERTIFICATE

This is to certify that the present Project titled "THE STRUCTURAL AND OPTICAL PROPERTIES OF LITHIUM ALUMINA ZINC BORATE GLASS DOPED WITH  $\text{Eu}^{2+}$ " has been the outcome of an original study carried out by **Mr. L YUVARAJ KUMAR** under the supervision of **Dr. THEJAS R** towards the partial fulfilment of the requirements for the degree of Masters of Science in Physics at The National College, Jayanagar, Bangalore.

This is to further certify that the work reported is his independent original investigation and herein does not form a part of any other thesis/dissertation, on the previously forming of which a degree or diploma or a certificate has been conferred upon this or any other student in the past.



Signature of Project Supervisor

**Dr. THEJAS R**

Assistant Professor

Department of Post Graduate &

Research in physics

The National College Jaynagar-560070

The Co-ordinator  
Dept. of PG Studies in Physics  
The National College  
AUTONOMOUS  
Jayanagar, Bangalore - 70.  
Co-Ordinator Signature



Signature of the principal

PRINCIPAL

The National College  
Jayanagar, Bangalore-70.

Date: 23 November 2023

Place: Bengaluru





# The National College (Autonomous)

Jayanagar, Bengaluru – 70

DEPARTMENT OF POST GRADUATE STUDIES AND RESEARCH IN PHYSICS

## CERTIFICATE

This is to certify that the present Project titled “ SYNTHESIS AND CHARACTERIZATION OF CALCIUM ZINC KITHIUM BOROPHOSPATE GLASSES” has been the outcome of an original study carried out by **Mr. SRIKANTH SR** under the supervision of **Dr. P. NAGARAJU** towards the partial fulfilment of the requirements for the degree of Masters of Science in Physics at The National College, Jayanagar, Bangalore.

This is to further certify that the work reported is his/her independent original investigation and herein does not form a part of any other thesis / dissertation, on the previously forming of which a degree or diploma or a certificate has been conferred upon this or any other student in the past.



Signature of Project Supervisor

**Dr.P.NAGARAJU**  
Project supervisor  
Department of Post Graduate Studies &  
Research in Physics  
The National College Jayanagar,  
Bangalore-560070



Co-Ordinator Signature  
The Co-ordinator  
Dept. of PG Studies in Physics  
The National College  
AUTONOMOUS  
Jayanagar, Bangalore - 70.



PRINCIPAL  
The National College  
Jayanagar, Bangalore



Date: 23 November 2023

Place: Bengaluru



|| ಶ್ರದ್ಧಾಃ ಪರಮಾ ಗತಃ ||

# THE NATIONAL COLLEGE

**AUTONOMOUS**  
**JAYANAGAR, BANGALORE-560070**

*X-Ray Diffraction Studies on Ag Nanoparticles and Thin films*

A PROJECT REPORT

Submitted by

**VINAY D**  
**20NCJPP011**

*As partial fulfillment of award degree in*

**MASTER OF SCIENCE (Physics)**

UNDER THE GUIDANCE OF

Dr. K T Vasudevan

Co-ordinator

Dr. Abhiram J

Assistant Professor

Department of Post Graduate Studies & Research in Physics

The National College Jayanagar, Bangalore-560 070

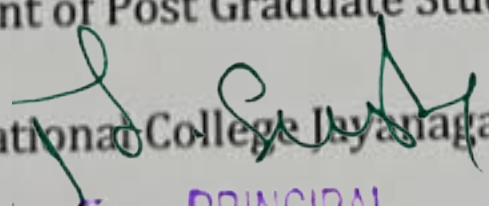
  
PRINCIPAL  
The National College  
Jayanagar, Bangalore-560070  
2022







॥ वाचं धेनुमुपासीत ॥

# THE NATIONAL COLLEGE

AUTONOMOUS  
JAYANAGAR, BANGALORE-560070

*X-RAY DIFFRACTION STUDIES ON COPPER OXIDE  
NANOPARTICLES AND THIN FILMS*

A PROJECT REPORT

Submitted by

**SIDDIVINAYAKA T S**  
**20NCJPP009**

*As partial fulfillment of the award of the degree in*

**MASTER OF SCIENCE (Physics)**

**UNDER THE GUIDANCE OF**

Dr. K T Vasudevan

Co-ordinator

Dr. Abhiram J

Assistant Professor

Department of Post Graduate Studies & Research in Physics

The National College Jayanagara, Bangalore-560 070

PRINCIPAL  
The National College  
Jayanagar, Bangalore-70.

2022





॥ ज्ञानं सदासुखं नमः ॥

# THE NATIONAL COLLEGE

NAAC ACCREDITED "A" GRADE

JAYANAGAR, BANGALORE-560 070

## OPTICAL PROPERTIES OF ALKALI BARIUM ALUMINO BORATE GLASS

A PROJECT REPORT

Submitted by

**Shubham Jha**

*As Partial fulfillment of award of the degree in*

MASTER OF SCIENCE (Physics)

UNDER THE GUIDANCE OF

**Dr. Abhiram J,**

Assistant Professor,

Department of PG Studies and Research in Physics

The National College, Jayanagar, Bangalore – 560070

PRINCIPAL  
(2022)  
The National College  
Jayanagar, Bangalore-70.







॥ ज्ञानं विद्यायां शान्तिः ॥

# THE NATIONAL COLLEGE

NAAC ACCREDITED "A" GRADE  
JAYANAGAR, BANGALORE-560 070

## NON-LINEAR OPTICAL PROPERTIES OF ALKALI BARIUM ALUMINOBORATE GLASS

A PROJECT REPORT  
Submitted by

**R Dhanya**

*As Partial fulfilment of award of the degree in*  
MASTER OF SCIENCE (Physics)

**UNDER THE GUIDANCE OF**

**Dr. Abhiram J**

Assistant professor,

Department of PG Studies and Research in Physics  
The National College, Jayanagar, Bangalore - 560070

PRINCIPAL

The National College  
Jayanagar, Bangalore-70.



(2022)



|| ಶ್ರದ್ಧಾಢು ಪರಮಾ ಗಿಃ ||

# THE NATIONAL COLLEGE

NAAC ACCREDITED WITH GRADE "A"  
JAYANAGAR, BANGALORE-560070

A STUDY ON PHYSICAL AND OPTICAL PROPERTIES OF ALKALI ALUMINO  
BORATE GLASSES DOPED WITH  $V_2O_5$

A PROJECT REPORT  
Submitted by

**CHANDANA SRINIVASU**  
**20NCJPP002**

*As a partial fulfillment of the award of the degree in*

MASTER OF SCIENCE (Physics)

UNDER THE GUIDANCE OF

Dr. Abhiram J

Assistant Professor,

Department of Post Graduate Studies & Research in Physics

The National College Jayanagar, Bangalore-560070

PRINCIPAL

The National College  
Jayanagar, Bangalore-70.



2022





|| ಶ್ರೀಮತು ವಿದ್ಯಾಪೀಠಃ ||

# THE NATIONAL COLLEGE

NAAC ACCREDITED "A" GRADE

JAYANAGAR, BANGALORE-560070

INFRARED SPECTROSCOPIC ANALYSIS OF ALKALI ALUMINO BORATE GLASSES DOPED  
WITH  $V_2O_5$

## A PROJECT REPORT

Submitted by

**Kanaka G**

20NCJPP003

*As a partial fulfillment of the award of the degree in*

MASTER OF SCIENCE (Physics)

UNDER THE GUIDANCE OF

**Dr. Abhiram J**

Assistant professor,

Department of Post Graduate Studies & Research in Physics

The National College, Jayanagar, Bangalore-560070

PRINCIPAL  
The National College  
Jayanagar, Bangalore-70.



2022



|| ಶ್ರದ್ಧಾಹಿ ಪರಮಾ ಗಣಿ: ||

# THE NATIONAL COLLEGE

NAAC ACCREDITED "A" GRADE  
JAYANAGAR, BANGALORE-560 070

## INFRA-RED SPECTROSCOPIC ANALYSIS OF ALKALI SODIUM BORATE GLASSES DOPED WITH $V_2O_5$

A PROJECT REPORT  
Submitted by

**Achala Dattatreya Hegde**

**20NCJPP001**

*As Partial fulfilment of award of the degree in*  
MASTER OF SCIENCE (Physics)

UNDER THE GUIDANCE OF

**Dr. Abhiram J**

Assistance Professor,

Department of PG Studies and Research in Physics  
The National College, Jayanagar, Bangalore - 560070

PRINCIPAL

The National College  
Jayanagar, Bangalore-70.



(2022)





|| ಶ್ರದ್ಧಾ ಪೂಜಾ ಸಮಾಜ ||

# THE NATIONAL COLLEGE

NACC ACCREDITED "A" GRADE  
JAYANAGAR, BANGALORE-560 070

INFRARED SPECTROSCOPIC ANALYSIS OF LITHIUM BARIUM  
ALUMINO BORATE GLASSES DOPED WITH  $V_2O_5$

## A PROJECT REPORT

Submitted by

**Mamatha S K**  
**20NCJPP004**

*As partial fulfillment of the award of the degree in*

**MASTER OF SCIENCE (Physics)**

UNDER THE GUIDANCE OF

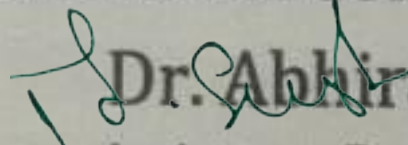
  
**Dr. Abhiram J**  
Assistant Professor

The National College  
Jayanagar, Bangalore-70.

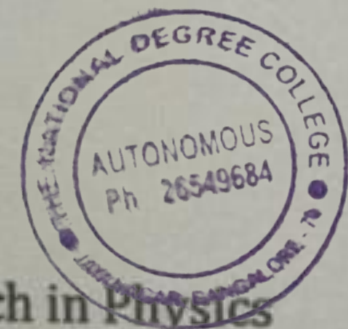

Department of Post Graduate Studies & Research in Physics

The National College Jayanagar, Bangalore-560 070

2022

Name: Pallavi V

Dear Pallavi,

Thank you for seeking and fulfilling an election-specific five-day internship with NDTV for coverage of the Karnataka Assembly Elections 2023.

We wish you the very best for your future.

Best Wishes,



**Anuradha Srinivasan**  
**Head-HR NDTV Group**



**PRINCIPAL**  
**The National College**  
**Jayanagar, Bangalore-70.**





Name: Meghana M

Dear Meghana,

Thank you for seeking and fulfilling an election-specific five-day internship with NDTV for coverage of the Karnataka Assembly Elections 2023.

We wish you the very best for your future.

Best Wishes,

**Anuradha Srinivasan**  
**Head-HR NDTV Group**

**PRINCIPAL**  
**The National College**  
**Jayanagar, Bangalore-70.**



Name: Lohith G

Dear Lohith,

Thank you for seeking and fulfilling an election-specific five-day internship with NDTV for coverage of the Karnataka Assembly Elections 2023.

We wish you the very best for your future.

Best Wishes,



**Anuradha Srinivasan**  
**Head-HR NDTV Group**

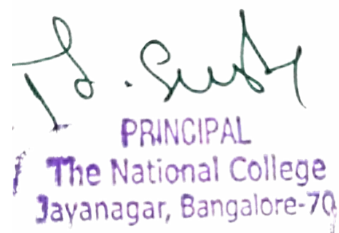

**PRINCIPAL**  
**The National College**  
**Jayanagar, Bangalore-70.**





Name: Kunjal Narwal

Dear Kunjal,

Thank you for seeking and fulfilling an election-specific five-day internship with NDTV for coverage of the Karnataka Assembly Elections 2023.

We wish you the very best for your future.

Best Wishes,



**Anuradha Srinivasan**  
**Head-HR NDTV Group**



**PRINCIPAL**  
**The National College**  
**Jayanagar, Bangalore-70.**





सेंटर फॉर डेवलपमेंट ऑफ टेलीमैटिक्स  
भारत सरकार का दूरसंचार प्रौद्योगिकी केन्द्र

Centre for Development of Telematics  
TELECOM TECHNOLOGY CENTRE OF GOVT. OF INDIA

27 मार्च, 2023

प्रमाणपत्र  
**CERTIFICATE**

प्रमाणित किया जाता है कि नेशनल कॉलेज जयनगर, बेंगलुरु से सुश्री कीर्तना जयप्रकाश रोल नं. P03PA21S0001 ने 18 जनवरी 2023 से 17 मार्च 2023 तक सेंटर फॉर डेवलपमेंट ऑफ टेलीमैटिक्स, बेंगलूर के ज्ञान प्रबंधन समूह में "Solar Powered Wi-Fi & AOI" शीर्षित विषय पर प्रोजेक्ट की है। उनका कार्य निष्पादन अच्छा पाया गया।

This is to certify that **Ms Keerthana Jayaprakash**, bearing Reg. No. P03PA21S0001 from **National College Jayanagar**, Bengaluru has done Project training in Knowledge Management Group, Centre for Development of Telematics, Bangalore, from 18th January 2023 to 17th March 2023 on the topic titled "**Solar Powered Wi-Fi & AOI**". His/her performance was found to be good.

वाई.वी.एस. लक्ष्मी 27/3/2023

डॉ. वाई.वी.एस. लक्ष्मी / Dr. Y.V.S. LAKSHMI

ग्रुप लीडर / Group Leader

ज्ञान प्रबंधन समूह / Knowledge Management Group

डॉ. वाई.वी.एस. लक्ष्मी/Dr. Y.V.S. Lakshmi  
ग्रुप लीडर - आईपीआर, मार्केटिंग एवं कोमर्सियल  
Group Leader - IPR, Marketing & Commercial  
सेंटर फॉर डेवलपमेंट ऑफ टेलीमैटिक्स  
Centre for Development of Telematics  
भारत सरकार/GOVT. OF INDIA  
इलेक्ट्रॉनिक्स सिटी फेज-1, होसूर रोड, बेंगलूर - 560 100.  
Electronics City Phase-1, Hosur Road, Bangalore - 560 100.





Name: Gowthami

Dear Gowthami,

Thank you for seeking and fulfilling an election-specific five-day internship with NDTV for coverage of the Karnataka Assembly Elections 2023.

We wish you the very best for your future.

Best Wishes,



**Anuradha Srinivasan**  
**Head-HR NDTV Group**



**PRINCIPAL**  
**The National College**  
**Jayanagar, Bangalore-70**



Name: Deepthi M

Dear Deepthi,

Thank you for seeking and fulfilling an election-specific five-day internship with NDTV for coverage of the Karnataka Assembly Elections 2023.

We wish you the very best for your future.

Best Wishes,



**Anuradha Srinivasan**  
**Head-HR NDTV Group**



**PRINCIPAL**  
**The National College**  
**Jayanagar, Bangalore-70.**







|| ಶ್ರೀಮತು ವಸುದೇವಾ ಕುಃ ||

# THE NATIONAL COLLEGE

Autonomous

Jayanagar, Bangalore-560070

## DEPARTMENT OF ELECTRONICS

### CERTIFICATE

This is to certify the project report titled "**Smart Door System**" is a bonafede record of work done by **Mary Prerana.A [20NCJS229]** and **Vedavidhya [20NCJS215]** in partial fulfilment of the requirements of the Bachelor of Science from THE NATIONAL COLLEGE, Jayanagar, for the academic year 2023-2024. The project has been approved as it satisfies the academic requirement in the respect of the project work prescribed for the VI Semester B.Sc.

.....*M. Mahadev*.....

.....*Chelluvapa S*.....

Prof .MAHADEV M (MSc, MPhil)

Prof .CHELLUVAPA S (MSc)

[ASSOC PROF,

[HOD and INTERNAL]

AND INTERNAL GUIDE]

*J. Subh*  
PRINCIPAL

The National College  
Jayanagar, Bangalore-70.



VALUED BY:

1) *Chelluvapa S*

2) *Mahadev*

Date *30-8-23*

DATE OF EXAM:

# THE NATIONAL COLLEGE

Autonomous

Jayanagar, Bangalore-560070

## DEPARTMENT OF ELECTRONICS

### CERTIFICATE

This is to certify the project report titled "*SMART PARKING SYSYTEM*" is a bonafide record of work done by *PADMANABHA N KATTI* [20NCJS214], *KARNA R* [20NCJS228] & *RAMYASHREE G* [16NCJS239] in partial fulfilment of the requirements of the Bachelor of Science from THE NATIONAL COLLEGE, Jayanagar, for the academic year 2022-2023. The project has been approved as it satisfies the academic requirement in the respect of the project work prescribed for the 6th Semester B.Sc.

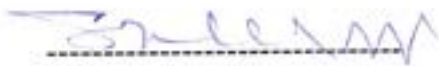

PROF.CHELLUVAPA S  
[HOD & INTERNAL GUIDE]



PROF.MAHADEV M  
[ASSOC PROF, INTERNAL]



PRINCIPAL  
The National College  
Jayanagar, Bangalore-70

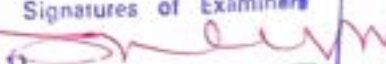
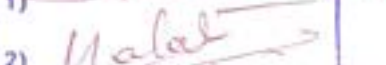

VALUED BY:

<b>VALUED</b>	
Signatures of Examiners	
1)	
2)	
Date	30-8-2023

Name:

Date of Exam:



# THE NATIONAL COLLEGE

Autonomous Jayanagar,  
Bangalore-560070

## DEPARTMENT OF ELECTRONICS

### CERTIFICATE

This is to certify the project report titled "*IOT-BASED AIR POLLUTION MONITORING SYSTEM*" is a bonafide record of work done by *SRIKANTH N [20NCJS225]* and *SHARAN K [20NCJS227]* in partial fulfillment of the requirements of the Bachelor of Science from THE NATIONAL COLLEGE, Jayanagar, for the academic year 2022-2023. The project has been approved as it satisfies the academic requirement in the respect of the project work prescribed for the 6<sup>th</sup> Semester B.Sc.

.....*M. Mahadev M*.....  
Prof. MAHADEV M (MSc, MPhil)  
[ASSOC PROF, and INTERNAL GUIDE ]

.....*S. Chelluvapa S*.....  
Prof. CHELLUVAPA S (MSc)  
[HOD and INTERNAL]

VALUED BY:

VALUED	
Signatures of Examiners	
1)	<i>S. Chelluvapa S</i>
2)	<i>M. Mahadev M</i>
Date	<i>30-08-2023</i>

NAME:

DATE OF EXAM:

*S. Chelluvapa S*  
PRINCIPAL  
The National College  
Jayanagar, Bangalore-70.



# THE NATIONAL COLLEGE

Autonomous

Jayanagar, Bangalore-560070

## DEPARTMENT OF ELECTRONICS

### CERTIFICATE

This is to certify the project report titled "**SURVEILLANCE ROBOT ESP32 CAM**" is a Bonafede record of work done by **DEVAMSH.U [20NCJS223]** and **YESHWANTH.R [20NCJS226]** in partial fulfilment of the requirements of the Bachelor of Science from **THE NATIONAL COLLEGE, Jayanagar**, for the academic year 2022-2023. The project has been approved as it satisfies the academic requirement in the respect of the project work prescribed for the 6<sup>th</sup> Semester B.Sc.

.....*M. Mahadeva*.....

Prof .MAHADEV M (MSc, MPhil)  
[ASSOC PROF, and INTERNAL GUIDE ]

.....*Chelluvapa S*.....

Prof .CHELLUVAPA S (MSc)  
[HOD and INTERNAL]

VALUED BY:

VALUED	
Signatures of Examiners	
1)	<i>[Signature]</i>
2)	<i>[Signature]</i>
Date	30-1-2023
PRINCIPAL The National College Jayanagar, Bangalore-70.	

NAME

DATE OF EXAM





# THE NATIONAL COLLEGE

Autonomous Jayanagar,  
Bangalore-560070

## DEPARTMENT OF ELECTRONICS

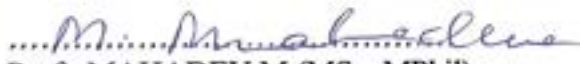

### CERTIFICATE

This is to certify the project report titled "*IOT-BASED AIR POLLUTION MONITORING SYSTEM*" is a bonafide record of work done by *SRIKANTH N* [20NCJS225] and *SHARAN K* [20NCJS227] in partial fulfillment of the requirements of the Bachelor of Science from **THE NATIONAL COLLEGE, Jayanagar**, for the academic year 2022-2023. The project has been approved as it satisfies the academic requirement in the respect of the project work prescribed for the 6<sup>th</sup> Semester B.Sc.

  
Prof. MAHADEV M (MSc, MPhil)  
[ASSOC PROF, and INTERNAL GUIDE ]

  
Prof. CHELLUVAPA S (MSc)  
[HOD and INTERNAL]

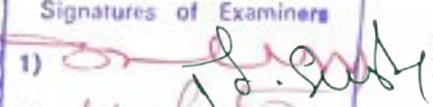
VALUED BY:

VALUED	
Signatures of Examiners	
1)	
2)	
Date	30-05-23

PRINCIPAL  
The National College  
Jayanagar, Bangalore-70

NAME:

DATE OF EXAM:





|| ಪ್ರಜ್ಞಾ ಪರಮಾಣು ಸಿದ್ಧಿ ||

# THE NATIONAL COLLEGE

Autonomous

Jayanagar, Bangalore-560070

## DEPARTMENT OF ELECTRONICS

### CERTIFICATE

This is to certify the project report titled "**HEALTH MONITORING SYSTEM**" is a bonafide record of work done by **GOMATH KUMAR L [20NCJS224]** and **BHARATH R [20NCJS222]** in partial fulfilment of the requirements of the Bachelor of Science from **THE NATIONAL COLLEGE, Jayanagar**, for the academic year **2022-2023**. The project has been approved as it satisfies the academic requirement in the respect of the project work prescribed for the **VI Semester B.Sc.**

.....*M. Mahadevm*.....

.....*Chelluvapas*.....

Prof .MAHADEVM (MSc, MPhil)  
[ASSOC PROF,

Prof.CHELLUVAPAS (MSc)  
[HOD and INTERNAL

PRINCIPAL  
The National College  
Jayanagar, Bangalore-70.



AND INTERNAL GUIDE]

VALUED BY:

<b>VALUED</b>	
Signatures of Examiners	
1)	<i>Chelluvapas</i>
2)	<i>Mahadevm</i>
Date	<i>30-8-2023</i>

NAME:

DATE OF EXAM:



# THE NATIONAL COLLEGE

Autonomous

Jayanagar, Bangalore-560070

## DEPARTMENT OF ELECTRONICS

### CERTIFICATE

This is to certify the project report titled "*SURVEILLANCE ROBOT ESP32 CAM*" is a Bonafede record of work done by *DEVAMSH.U [20NCJS223]* and *YESHWANTH.R [20NCJS226]* in partial fulfilment of the requirements of the Bachelor of Science from **THE NATIONAL COLLEGE, Jayanagar**, for the academic year 2022-2023. The project has been approved as it satisfies the academic requirement in the respect of the project work prescribed for the 6<sup>th</sup> Semester B.Sc.

.....*M. Mahadev M*.....

.....*Chelluvapa S*.....

Prof .MAHADEV M (MSc, MPhil)  
 [ASSOC PROF, and INTERNAL GUIDE ]

Prof .CHELLUVAPA S (MSc)  
 [HOD and INTERNAL]

VALUED BY:

<b>VALUED</b>	
Signatures of Examiners	
1) <i>[Signature]</i>	PRINCIPAL The National College Jayanagar, Bangalore-70.
2) <i>[Signature]</i>	
Date <i>30-8-2022</i>	

NAME \_\_\_\_\_  
 DATE OF EXAM \_\_\_\_\_





|| ಪ್ರಜ್ಞೆ ಪಡೆದು ಗಣಿ ||

# THE NATIONAL COLLEGE

Autonomous

Jayanagar, Bangalore-560070

## DEPARTMENT OF ELECTRONICS

### CERTIFICATE

This is to certify the project report titled "**HEALTH MONITORING SYSTEM**" is a bonafide record of work done by **GOMATH KUMAR L [20NCJS224]** and **BHARATH R [20NCJS222]** in partial fulfilment of the requirements of the Bachelor of Science from **THE NATIONAL COLLEGE, Jayanagar**, for the academic year **2022-2023**. The project has been approved as it satisfies the academic requirement in the respect of the project work prescribed for the **VI Semester B.Sc.**

.....*M. Mahadevm*..... *Chelluvapas*.....

Prof .MAHADEVM (MSc, MPhil)  
[ASSOC PROF,

Prof.CHELLUVAPAS (MSc)  
[HOD and INTERNAL]

AND INTERNAL GUIDE]

*D. Subh*  
PRINCIPAL

VALUED BY:

VALIDATED

The National College  
Jayanagar, Bangalore-70

Signatures of Examiners

1) *Chelluvapas*

2) *Mahadevm*

Date *30-8-2023*

NAME:

DATE OF EXAM:





Bisleri

BISLERI INTERNATIONAL PVT. LTD.

Date: 27/08/2022

**TO WHOM SO EVER IT MAY CONCERN**

This is to certify that Ms.Sushmitha N (20NCJPCM05) M.Com student from The National College Autonomous, Jayanagar, Bangalore has successfully completed her project work on the topic "A Study on Marketing Strategies and Brand Image with Remarks to Bisleri Mineral Water" under our guidance.

We wish her all the success in her future endeavors.

For Bisleri International Pvt. Ltd.

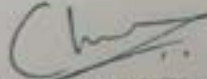
  
Authorised Signatory

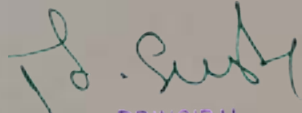
  
PRINCIPAL  
The National College  
Jayanagar, Bangalore-70



29/33, Udayagiri Village, Devanhalli Taluk, Bengaluru – 562 110  
Customer Care: +91-99009 79800 | E-mail: bangalore@bisleri.co.in

**TO WHOM SO EVER IT MAY CONCERN**

This is to certify that Ms.Suchita H (20NCJPCM04) M.com student The National College Autonomous, Jayanagar, Bangalore has successfully completed the project work on "A STUDY ON E-RECRUITMENT IN HUMAN RESOURCE DEPARTMENT"

During the period of her project with us she has exhibited punctuality and diligence.

We wish her every success in life.

**For Strides Pharma Science Limited,**



MANJULA RAMURTHY  
Sr. Manager - HR



*Suchita H*  
PRINCIPAL

The National College  
Jayanagar, Bangalore-70.







# PEOPLE STREET CONSULTANCY

No.33, M V Road, V V Puram, Bangalore 560004

PH: 9742164459/7812994687

E-Mail ID: peoplestreet.consultants@gmail.com

Date: 02<sup>nd</sup> Sept, 2022

## CERTIFICATE

This is to certify that **Ms. Pruthvi H R**, Register no. **20NCJPCM03**, 4<sup>th</sup> Semester M.Com, a student of The National College, Jayanagar, has completed her project for the period of 30 days in the field of Payroll starting from 04<sup>th</sup> August, 2022 to 30<sup>th</sup> August, 2022 with reference to People Street Consultancy.

During the project she was exposed to various activities in payroll department. We found her to be meticulous, inquisitive hardworking. she was very much interested in to learn the functions of our division and also willing to put efforts and get into the depth of the concept to understand well.

Her association with us was very fruitful and wish her all the best for his future endeavors.

For People Street Consultancy

Authorised Signatory

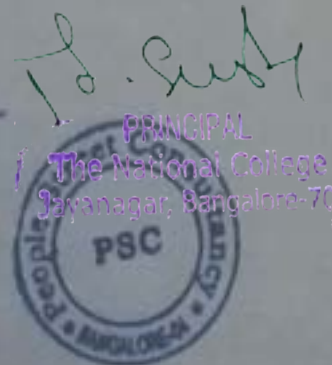

PRINCIPAL  
The National College  
Jayanagar, Bangalore-70



**SRI VINAYAKA WOMEN SELF-HELP GROUP**

**Muninagra village Kaggalahalli Grama, harohalli hobali, kanakapura thaluku,  
Ramanagara district 562112**

---

**Date: 30.09.2022**

**Proprietor**

**Mamatha J.K**

**CERTIFICATE**

**This is certify that Miss. Pranitha (Reg. No. 20NCJPCM02) M.COM Student of National college Jayanagar Bangalore, Has Successfully completed her project work "Women Empowerment Through Self-Help Group (A study in sri vinayaka women self-help group)" at Muninagra village Kaggalahalli Grama, harohalli hobali, kanakapura thaluku , Ramanagara district 562112, under our guidance**

**We wish her all the best and success in all her future endeavors.**

**Warm regards,**

**PROPRIETOR**

**MAMATHA J.K**

*[Handwritten Signature]*  
**PRINCIPAL**  
**The National College**  
**Jayanagar, Bangalore-70**

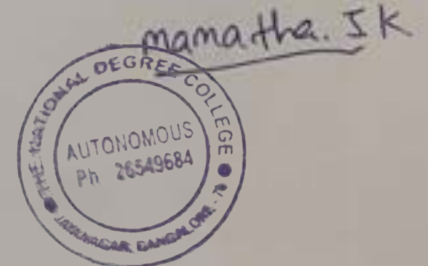





F5, 5th Floor -4 &  
5, Pinnacle Business Park,  
Mahakali Caves Road,  
Andheri (East),  
Mumbai-  
400093, India.  
[www.delex.in](http://www.delex.in)

Delex Cargo India Private Limited

## INTERNSHIP COMPLETION CERTIFICATE

This is to certify that YUVARAJ M Reg No.20NCJC904 B.COM Final Year student of The National College, Autonomous, Jayanagar, Bangalore has successfully completed internship of six weeks under the guidance of JYOTHI PRASAD at this organization, towards the fulfillment of the award of 'Bachelor of Commerce' during the year 2022-23.

During the period of his/her internship he/she has exhibited punctuality and diligence. We wish his/her every success in life.

DATE :21/11/2022

Thankyou

Your regards,

JYOTHIPRASADTS



Operationmanager

PRINCIPAL  
The National College  
Jayanagar, Bangalore-70.





## Aghanta Retail Pvt. Ltd.

Corporate Office: 237 1<sup>st</sup> Floor Patil Business Center, RMV Extension, Dr. C.V. Raman Road,  
Sadashivanagar Bengaluru 80  
www.alpinetvraapl.com

### PROJECT COMPLETION LETTER

### TO WHOMSOEVER IT MAY CONCERN

This is to certify that Mr. Yuvaraj, M bearing Reg. No. 20NCIC904 of VI Semester B.Com student, The National College, Autonomous, Jayanagar, Bangalore has successfully completed the project work for the period of 06 weeks 24<sup>th</sup> April 2023 to 27<sup>th</sup> May 2023 under the guidance of Mr. Vinay Kumar R Marketing Manager at our organization towards the fulfillment of award of "Bachelor of Commerce" during the year 2022-23.

The title of his project work was: - Marketing strategies of the products.

During the period of his project with us he has exhibited punctuality and diligence. We wish him every success in life.

Thanking you.

For and on behalf of Aghanta Retail PVT Limited.

Mr. Vinay Kumar R

Marketing Manager.

Aghanta Retail Pvt. Ltd.  
Alpine Viva Owners Welfare  
Association (AVOWA)

S.No. 139, Whitefield, Hoskote Road  
Sai Gardens, Seegehalli  
Krishnarajapura, Bangalore-560 047

PRINCIPAL  
The National College  
Jayanagar, Bangalore-70.







Reg: 903

Date: 23-11-2022

## CERTIFICATE OF COMPLETION

This is to certify that Shreyas G, a student from National College Jayanagar, has interned with Samarathanam Trust for the Disabled from 7<sup>th</sup> October 2022 to 21<sup>st</sup> November 2022.

The student has successfully completed the work. He has worked in the HR department to understand the organization structure, How NGOs work, and to gain knowledge on the HR department along with other department information.

We found him responsible, efficient and their conduct during the internship was satisfactory. We found him sincere throughout the whole period and we wish him all the best in his future endeavors.

This organization is a registered NGO - Trust working towards the education, empowerment of persons with visual impairment, other disabilities, and underprivileged people through various developmental activities aided by technically assistive devices and to create an inclusive and indiscriminate society for them.

*Naveen B V*  
23/11/22  
Naveen B V  
Lead Volunteer



*[Signature]*  
PRINCIPAL  
The National College  
Jayanagar, Bangalore-70.



## PROJECT COMPLETION LETTER

### TO WHOMSOEVER IT MAY CONCERN

This is to certify that Mr. Shreyas G bearing Reg. No. 20NCJC903 of VI Semester B.Com student, The National College, Autonomous, Jayanagar, Bangalore has successfully completed the project work from 13<sup>th</sup> April 2023 to 18<sup>th</sup> May 2023 under the guidance of Akash Gadiya, Director at our organisation towards the fulfilment of award of "Bachelor of Commerce" during the year 2023-24.

The title of his project work was Digital Marketing in Healthcare.

During the period of his project with us he has exhibited punctuality and diligence. We wish him every success in life.

Thanking you.

For Novalife Healthcare

For NOVALIFE HEALTHCARE

18/05/23.  
Proprietor  
Authorised sign

*[Signature]*  
PRINCIPAL  
The National College  
Jayanagar, Bangalore-70.





## INTERNSHIP COMPLETION CERTIFICATE

This is to certify that Ms. Savitha Bai M, Reg No.20NCJC901 B.Com Final Year student of The National College, Autonomous, Jayanagar, Bangalore has successfully completed internship on Recruitment and Documentation from 10-10-2022 to 09-11-2022 under the guidance of JAGADISH C [HR Manager ] in Sangeetha Mobiles Pvt Ltd, towards the fulfillment of the award of 'Bachelor of Commerce' during the year 10 Oct 2022 to 9 Nov 2022.

During the period of her internship, she has exhibited punctuality and diligence. We wish her every success in life.

Yours Sincerely,  
For Sangeetha Mobiles Pvt. Ltd.

For Sangeetha Mobiles Pvt. Ltd.

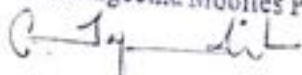

Authorized Signatory

Jagadish C  
HR Manager



PRINCIPAL

The National College  
Jayanagar, Bangalore-70.



**Sangeetha Mobiles Private Limited**

Head Office : # 1183, 22nd 'A' Cross, Banashankari 2nd Stage, Bangalore-560 070.

Tel. : 080-4939 7000 / 080-4939 7111 [www.sangeethamobiles.com](http://www.sangeethamobiles.com)

Karnataka | Andhra Pradesh | Telangana | Tamil Nadu | Puducherry | Gujarat | Uttar Pradesh



# A. K. HEALTH CARE

Distributors for Health Care Medical Electronic Products

# 49/10(A), 2nd Floor, 1st Cross, Roshan Colony, Jayanagar, Bangalore - 560 041  
Mobile : 98457 60444

Date : .....

## PROJECT COMPLETION LETTER

### TO WHOMSOEVER IT MAY CONCERN

This is to certify that Mr. Shaik Shazar bearing Reg. No. 20NCJC902 of VI Semester B.Com student, The National College, Autonomous, Jayanagar, Bangalore has successfully completed the project work for the period of 06 weeks from 01/05/2023 -14/06/2023 , under the guidance of Satish BK , Manager at our organisation towards the fulfilment of award of "Bachelor of Commerce" during the year 2023-24.

The title of his project work was Budgetary Control.

During the period of his project with us he has exhibited punctuality and diligence. We wish him every success in life.

Thanking you.

AK HEALTH CARE PVT.LTD

**A K HEALTH CARE**  
Shop No.1 & 2 No. 1,3rd Cross,  
Umar Bagh Layout, Jp Nagar Post  
Karakapura Main Road  
Bangalore-78

  
PRINCIPAL  
The National College  
Jayanagar, Bangalore-70







Plot No.45 - 47, KIADB Industrial Area,  
Phase - II, Electronic City , Bengaluru - 560100  
(Karnataka) India. +91-80-6780778

**PROJECT COMPLETION LETTER**

**TO WHOMSOEVER IT MAY CONCERN**

This is to certify that Mr./ MS. SAVITHA BAI . M bearing Reg No. 20NCJC901 of VI Semester B.Com student, The National College, Autonomous, Jayanagar, Bangalore has successfully completed the project work for the period of 4 weeks (10/04/2023 -3/05/2023) under the guidance of (SAMYAM &MANAGER) at our organisation to wards the fuilfilment of award of "Bachelor of commerce " during the year 2023-2024.

The title of his/ her project work was  
**DATA ANALYSIS ADA DATA HANDLING UNDER IT COMPANY**  
During the period of her project with us she has exhibited punctuality and diligence.

We wish her every success in life.

Thanking You .

For, TECH MAHINDRA

For TECH MAHINDRA LIMITED

Authorised signatory(with company seal)  
**GEORGE MUNDASSERY**  
VICE PRESIDENT

PRINCIPAL  
The National College  
Jayanagar, Bangalore-70.



## INTERNSHIP COMPLETION CERTIFICATE

This is to certify that Rakesh Singh Reg No. 20NCJC900, B.Com Final Year student of The National College, Autonomous, Jayanagar, Bangalore has successfully completed internship of six weeks under the guidance of Mr. Suresh M at this organization, towards the fulfillment of the award of 'Bachelor of Commerce' during the year 2022-23.

During the period of his internship, he has exhibited punctuality and diligence. We wish his every success in life.

Date: 28/11/2022

Place: Bangalore

SBI Credit Cards  
VP Customer Service Dept  
10th Floor, DLF Infinity Tower 'C'  
Block 2 Building 3, DLF Cyber City  
Gurgaon - 122002

  
PRINCIPAL  
The National College  
Jayanagar, Bangalore-70





**TO WHOMSOEVER IT MAY CONCERN**

This is to certify that **Mr. Rakesh Singh.N** bearing Reg No. **20NCJC900** of VI Semester B. Com, The National College, Autonomous, Jayanagar, Bangalore has successfully completed the project work for the period of 06 weeks starting from 27-03-2023 to 08-05-2023 under the guidance of Mr. Mukesh Singh at our organisation towards the fulfilment of award of "Bachelor of Commerce" during the year 2022-23.

The title of his/her project work was **OPERATION AND CLAIM PROCEDURE OF MOTOR VEHICLE INSURANCE.**

During the period of his project with us he has exhibited punctuality and diligence. We wish him every success in life.

Thanking you.

**MUKESH SINGH**

For I T 9 Technology Pvt. Ltd.

Authorised Signatory

**OTO CAPITAL.**

**PRINCIPAL**  
**The National College**  
**Jayanagar, Bangalore-70.**

**1 T 9 TECHNOLOGY Pvt. Ltd.**  
**# 71, 3rd Cross,**  
**MICO LAYOUT, JAYNAGAR**  
**BANGALORE - 560040**

TIN : 29440208029  
GSTIN : 29ALIPK7776Q12W



Mob: 9739710814

# ARUNACHALAM TRADERS

Dealers in : Wholesale & Retail Tea Powder, Suppliers of Assam, Darjiling, Nilgiri Tea & Spices  
# 6, Old Tharagupet Cross, G.S. Market, 1st Floor, Bangalore-560 053.

Ref:

Date.....

## INTERNSHIP COMPLETION CERTIFICATE

This is to certify that POOJA E Reg No.20NCJC899 B.Com Final Year student of The National College, Autonomous, Jayanagar, Bangalore has successfully completed internship of six weeks under the guidance of - PREM KUMAR at ARUNACHALAM TRADERS organisation, towards the fulfilment of the award of 'Bachelor of Commerce' during the year 2022-23.

During the period of her internship she has exhibited punctuality and diligence. We wish her every success in life.

For ARUNACHALAM TRADERS  
V.S. Idnayas  
Proprietor

(Authorised signature with seal)

Date: 12-01-2023

Place: BANGALORE

  
PRINCIPAL  
The National College  
Jayanagar, Bangalore-70.







# AKSHAY CERAMIC

**Manufacturers of Mosaics**

*Vitrified, Ceramic Tiles, Granite & Sanitary Fittings*

No. 25/6, Hommadevanahalli Village, Gottigere Post, Bannerghatta Road, Bangalore - 560 083



Date: 23-05-2023

## PROJECT COMPLETION LETTER

### TO WHOMSOEVER IT MAY CONCERN

This is to certify that Miss. Pooja.E bearing Reg.No. 20NCJC899 of VI Semester B.Com student, The National College, Autonomous, Jayanagar, Bangalore has successfully completed the project work for the period of 06 weeks 11-04-2023 to 22-05-2023 under the guidance of M.Satish Kumar (Manager) at our organisation towards the fulfilment of the award of "Bachelor of Commerce" during the year 2021-22.

The title of his project work was "A study on impact of implementation of GST across manufacturing concern."

During the period of his project with us he has exhibited punctuality and diligence. We wish her every success in life.

Thanking you.

Form,  
Akshay Ceramic

Authorised signatory

PRINCIPAL  
The National College  
Jayanagar, Bangalore-70.



03-11-2022

To,  
Dr. N K Satya Pal Sharma  
HOD- Department of Commerce  
The National College  
Autonomous  
Jayanagar, Bangalore-70

Dear Sir,

Subject: Internship Acceptance Letter- Kavya shree s 20NCJC898

This is to certify that Ms. Kavya shree s Reg No. 20NCJC898 has joined in our organisation on 07-10-2022 and she will be working as internship trainee in Mukta A2 Cinemas for the period of 45 days.

Thanking you







*Dr. Satya*  
PRINCIPAL

The National College  
Jayanagar, Bangalore-70.



**MUKTA A2 CINEMAS LIMITED**

Regd. Office: Mukta House, Behind Whistling Woods Institute, Filmcity Complex, Goregaon (East), Mumbai – 400065  
Telephone No. : (022) 33649400 | Fax No. - (022) 33649401 | CIN: U74999MH2016PLC2S7694  
www.muktaa2cinemas.com | Follow us on      /muktaA2cinemas





## TO WHOMSOEVER IT MAY CONCERN

This is to certify that Miss KAVYA SHREE.S bearing Reg. No.20NCJC898 of VI Semester B. Com student, The National College, Autonomous, Jayanagar, Bangalore has successfully completed the project work for the period of 04 weeks 16-04-2023 TO 16-05-2023 under the guidance of Mrs. Pooja, Human Resource at our organization towards the fulfilment of award of "Bachelor of Commerce" during the year 2022-23.

The title of her project work was " Human resource operation at ITC welcome hotel ".

During the period of her project with us she has exhibited punctuality and diligence. We wish her every success in life

Thanking You.

Authorized signatory company seal



*[Handwritten Signature]*  
PRINCIPAL

The National College

Welcomhotel by ITC Hotels, Richmond Road, Bengaluru #46, Richmond Rd, Victoria  
Layout, Bengaluru, Karnataka 560025



**ACCEPTANCE LETTER**

Date: 10/10/2022

To  
Dr. N K Satya Pal Sharma  
HOD- Department of Commerce  
The National College Autonomous  
Jayanagar, Bangalore- 70

Dear Sir,

**Subject: Internship Acceptance Letter – Mr. Aman Kumar Singh. G - 20NCJC894**

This is to certify that **Mr. Aman Kumar Singh. G Reg. No.20NCJC894** has joined in our organization on **10-10-2022** and he will be working as internship trainee in **Reliance Trends - Marketing Department** from **10-10-2022 to 14-11-2022**

Thanking You

Sincerely yours,

For Reliance Trends

  
**RELiance RETAIL LIMITED**  
Bhartiya City Centre, Thanisandra,  
Bangalore, Kamataka - 560 077

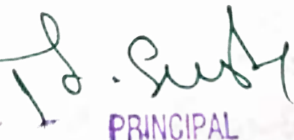
  
**PRINCIPAL**  
**The National College**  
Jayanagar, Bangalore-70.







# Swemed Biomedicals Pvt. Ltd.

## TO WHOMSOEVER IT MAY CONCERN

This is to certify that Mr. Aman Kumar Singh.G, bearing Reg.No. 20NCJC894 of VI Semester B.Com student, The National College, Autonomous, Jayanagar, Bangalore has successfully completed the project work for the period of 6 weeks, From 17/04/2023 to 20/05/2023 under the guidance of (HR MANAGER, KUMAR SHARMA) at our organisation towards the fulfilment of award of "Bachelor of Commerce" during the year 2022-23.

The title of his project work was Sales promotion towards social media marketing

During the period of his project with us he has exhibited punctuality and diligence. We wish his every success in life.

Thank you,

For,  
Swemed Biomedicals Pvt. Ltd

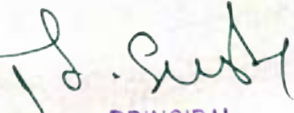
  
PRINCIPAL  
The National College  
Jayanagar, Bangalore-70.

BY SWEMED BIOMEDICALS PVT. LTD

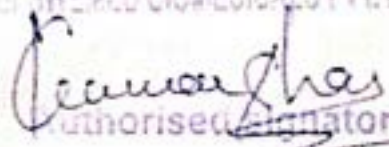
  
Authorised Signatory



CIN U31909KA2003PTC032979

29/1 first floor, Chunchanaghatta Cross, Yelachenahalli, Bengaluru 560062-08026551720

## INTERNSHIP COMPLETION CERTIFICATE

This is to certify that PAVAN RAO Reg No.20NCJC893 B.Com Final Year student of The National College, Autonomous, Jayanagar, Bangalore has successfully completed internship of six weeks under the guidance of -Samiksha at EKKI PUMPS organisation, towards the fulfilment of the award of 'Bachelor of Commerce' during the year 2022-23.

During the period of her internship she has exhibited punctuality and diligence. We wish her every success in life.

For EKKI PUMPS

  
Authorised Signatory

(Authorised signature with seal)

Date: 12/01/2023

Place: BANGALORE

  
PRINCIPAL  
The National College  
Jayanagar, Bangalore-70.





Date: 23/05/2023

PROJECT COMPLETION LETTER  
TO WHOMSOEVER IT MAY CONCERN

This is to certify that Mr. Pavan Rao R has been associated with our Organization as an Intern for the tenure from 11-04-2023 to 22-05-2023.

During the aforementioned tenure, Mr. Pavan Rao R remained engaged in his work with competence and sincerity. We found him able and efficient in executing all assigned tasks. He was found diligent, hardworking & Inquisitive.

We wish him all the best in his future endeavors.

Yours Cordially

For Neil Patel Digital India

B. Vinay Kumar

Authorized Signatory

*[Signature]*  
PRINCIPAL  
The National College  
Jayanagar, Bangalore-70.



## INTERNSHIP COMPLETION CERTIFICATE

This is to certify that Ms. Likitha V, Reg No.20NCJC892 B.Com Final Year student of The National College, Autonomous, Jayanagar, Bangalore has successfully completed internship on Recruitment and Documentation from 10-10-2022 to 09-11-2022 under the guidance of JAGADISH C [HR Manager ] in Sangeetha Mobiles Pvt Ltd, towards the fulfillment of the award of 'Bachelor of Commerce' during the year 10 Oct 2022 to 9 Nov 2022.

During the period of her internship, she has exhibited punctuality and diligence. We wish her every success in life.

Yours Sincerely,  
For Sangeetha Mobiles Pvt. Ltd.

For Sangeetha Mobiles Pvt. Ltd.

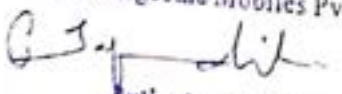
  
Authorized Signatory

Jagadish C  
HR Manager

  
PRINCIPAL  
The National College  
Jayanagar, Bangalore-70.



**Sangeetha Mobiles Private Limited**  
Head Office : # 1183, 22nd 'A' Cross, Banashankari 2nd Stage, Bangalore-560 070.  
Tel. : 080-4939 7000 / 080-4939 7111      [www.sangeethamobiles.com](http://www.sangeethamobiles.com)

Karnataka | Andhra Pradesh | Telangana | Tamil Nadu | Puducherry | Gujarat | Uttar Pradesh





## InPAT pro Private Limited

CIN: U90100KA2017PTC107434

(Formerly known as G-MaC Advisors Expert Accountants Pvt. Ltd.)

### Head Office:

#142/143, 3rd Floor, GR Plaza, DVG Road, Gandhi Bazaar,  
Basavanagudi, Bengaluru, Karnataka 560004

### TO WHOMSOEVER IT MAY CONCERN

This is to certify that **Ms. LIKITHA V** bearing Reg. No. 20NCJCR92 of VI Semester B.Com student, The National College, Autonomous, Jayanagar, Bangalore has successfully completed the project work for the period of 04 weeks (07-04-2023 to 06-05-2023) under the guidance of (Sudeep Singh M D, Manager) at our Organization towards the fulfillment of award of "Bachelor of Commerce" during the year 2022-23

The title of her project work was **HR BUSINESS DEVELOPMENT OPERATIONS IN InPAT pro PVT LTD.**

During the period of her project with us she has exhibited punctuality and diligence. We wish her great success in her future endeavours.

For and on behalf of InPAT pro Private Limited

Shashikala Shetty

Director



PRINCIPAL

The National College  
Jayanagar, Bangalore-70



Registered Office: #258/1, 1st Floor, Near 31E Bus Stop, Thyagrajnagar 2nd Block, Bangalore-28

[support@inpatpro.com](mailto:support@inpatpro.com)

[www.inpatpro.com](http://www.inpatpro.com)

+91 80 2676 3477

## INTERNSHIP COMPLETION CERTIFICATE

This is to certify that Mr.JAYANTH R NAIK, Reg No.20NCJC891, B.Com Final Year student of The National College, Autonomous, Jayanagar, Bangalore has successfully completed internship of 11 days under the guidance of Mr Ashok Savanth (Store Manager) at this organization (*Tanishq Bannerghatta Road*), towards the fulfillment of the award of '*Bachelor of Commerce*' during the year 2022-23.

During the period of his/her internship he/she has exhibited punctuality and diligence. We wish his/her every success in life.

  
(Authorized signature with seal)



Date:

Place:

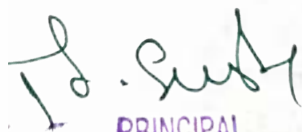
  
PRINCIPAL  
The National College  
Jayanagar, Bangalore-70.





**PROJECT COMPLETION LETTER**

Date: 16/06/2023

**TO WHOMSOEVER IT MAY CONCERN**

This is to certify that Mr. Jayanth R Naik bearing Reg. No. 20NCJC891 of VI Semester B.Com student, The National College, Autonomous, Jayanagar, Bangalore has successfully completed the project work for the period of 04 weeks 15/05/2023 to 15/06/2023 under the guidance of (Sindhu & HR Manager) at our organisation towards the fulfilment of award of "Bachelor of Commerce" during the year 2021-22.

The title of his project work was: **Leadership styles and its impacts.**

During the period of his project with us he has exhibited punctuality and diligence. We wish him every success in life.

Thanking you.

Katpro Technology.



*Mooz D.*

Authorised signatory (with company seal)

**Katpro Technologies Pvt. Ltd.**  
Grand #444, 2nd Floor, 15th  
5th Main, HSR Sector 6,  
Bangalore - 560102, Karnataka  
[www.katprotech.com](http://www.katprotech.com)

*D. Sindhu*  
PRINCIPAL  
The National College  
Jayanagar, Bangalore-70.



## INTERNSHIP COMPLETION CERTIFICATE

This is to certify that Mr.HARSHITH R, Reg No.20NCJC890, B.Com Final Year student of The National College, Autonomous, Jayanagar, Bangalore has successfully completed internship of 11 days under the guidance of Mr Ashok Savanth (Store Manager)at this organization (*Tanishq Bannerghatta Road*), towards the fulfillment of the award of '*Bachelor of Commerce*' during the year 2022-23.

During the period of his/her internship he/she has exhibited punctuality and diligence. We wish his/her every success in life.

  
(Authorized signature with seal)  

Date:

Place:

  
PRINCIPAL  
The National College  
Jayanagar, Bangalore-70.





Ref:

Date: 16/06/2023

## PROJECT COMPLETION LETTER

### TO WHOMSOEVER IT MAY CONCERN

This is to certify that Mr. Harshith R bearing Reg. No. 20NCJC890 of VI Semester B.Com student, The National College, Autonomous, Jayanagar, Bangalore has successfully completed the project work for the period of 04 weeks 15/05/2023 to 15/06/2023 under the guidance of Mr. Manjunath (Company Manager) at our organisation towards the fulfilment of award of "Bachelor of Commerce" during the year 2021-22.

The title of his project work was: **Employee motivation.**

During the period of his project with us he has exhibited punctuality and diligence. We wish him every success in life.

Thanking you.

D E Shaw & Co.



Authorised signatory (with company seal)

  
PRINCIPAL  
The National College  
Jayanagar, Bangalore-70.





# RAJNANDINI HOSPITAL

No. 3, 6th Cross, Old Bank Colony, Konanakunte, Bangalore - 560 062.

Hosp : 7829090239

Ph : 26320140

26323778

E-mail : info@rajnandini-hospital.com

DATE :

## INTERNSHIP COMPLETION CERTIFICATE

This is to certify that VIVEK.A, REG: 20NCJC888, B. Com Final Year student of The National College, Autonomous, Jayanagar, Bangalore has successfully completed internship of Six weeks under the guidance of Dr. Rajeev Loomba at Rajnandini Hospital, towards the fulfilment of the award of 'Bachelor of the commerce' during the year 2022-23.

During the period of his internship, he has exhibited punctuality and diligence. We wish his every success in life.

Dr. Rajeev Loomba  
B.Sc., MBBS.,

KMC Reg No. 33151

RAJNANDINI HOSPITAL

# 3, 6TH CROSS, OLD BANK COLONY

KONANAKUNTE, BANGALORE - 560 062

PH : 26320140 / 26323778



PRINCIPAL  
The National College  
Jayanagar, Bangalore-70

Date:

Place:





TO WHOMSOEVER IT MAY CONCERN

This is to certify that Mr. VIVEK.A bearing REG.NO 20NCJC888 of VI semester B.com student, The National college, Autonomous, Jayanagar, Bangalore has successfully completed the project work for the period of 4 Weeks under the guidance of Ms. MONISHA SHETTY (H.R) at our organisation towards the fulfilment of award of "Bachelor of commerce" during the year 2021-22.

The title of his/her project work was *Project Report on QR Code in Amazon*

During the period of his/her project with us he/she has exhibited punctuality and diligence. we wish him/her every success in life.

Thanking you.

for, (company name)



*Dr. Sush*  
PRINCIPAL  
The National College  
Jayanagar, Bangalore-70.



Authorised signatory with company seal

## INTERNSHIP COMPLETION CERTIFICATE

This is to certify that Ms.Vasundhara Kondapaku, Register No.20NCJC887, B.com Final Year student of The National College, Autonomous, Jayanagar, Bangalore has Successfully Completed Internship of 10 days Under the Guidance of  
At Tanishq Caratlane  
Jayanagar, Towards the fulfillment of the award of 'Bachelor of Commerce' during the year of 2022 - 23.

During the period of her internship she exhibited punctuality and diligence. We wish her every success in life.

Date :02/11/2022

Place:Bangalore

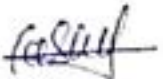

Hr-Executive

Tanishq Jayanagar

For SRSV AGRO COMPANY

Partner



PRINCIPAL

The National College  
Jayanagar, Bangalore-70.







TO WHOMSOEVER IT MAY CONCERN

This is to certify that Ms.VASUNDARA.K.S bearing REG.NO 20NCJC887 of VI semester B.com student, The National college, Autonomous, Jayanagar, Bangalore has successfully completed the project work for the period of 4 Weeks under the guidance of Ms. MONISHA SHETTY (H.R) at our organisation towards the fulfilment of award of "Bachelor of commerce" during the year 2021-22.

The title of his/her project work was *Project report on Duplicate selection in amazon audit.*

During the period of his/her project with us he/she has exhibited punctuality and diligence. we wish him/her every success in life.

Thanking you.

for, (company name)



*Dr. Sush*  
PRINCIPAL  
The National College  
Jayanagar, Bangalore-70.



Authorised signatory with company seal



Mc Donlads Pvt Ltd

Date:28/09/2022

To  
Head of the Department of Commerce  
The National Degree College  
7<sup>th</sup> Block, Jayanagar  
Bangalore-560070

Dear Sir/ Madam

**Sub:- Permission For Internships.**

With reference to your letter, We are pleased to permit **Mr.Supreeth N K, Reg No. 20NCJC885** Student of **B.com** from your College to undergo his Internship in our organization from **28-09-2022 to 12-11-2022.**

As this internship is a part of course curriculum the information gathered during his association with us has to be used for a academic purpose only.

Thanking You,

Mcdonald's India, Bangalore

**KISHOR**

**MCDONALDS ASSISTANT MANAGER**

 .124  
Banashankari Bangalore  
Hardcastle Restaurants Pvt. Ltd  
#2466, 2nd Cross, Opp. BDA Complex  
Banashankari, 2nd Stage, Bangalore - 560070.  
Manager Name:.....  
Manager Signature:.....  
Ph. No. 080 - 42005285

*To Supreeth*  
PRINCIPAL  
The National College  
Jayanagar, Bangalore-70.





Estd. 1916



# The Comptroller's Office Co-operative Bank Ltd.,

(A Bank of LIC Employees)

'Mahalakshmi', No. 209  
Cubbonpet Main Road  
Bengaluru - 560 002  
Ph : 22216820, 22278462  
Email : cocb1916@gmail.com  
Website : www.cocb1916.com

Ref.: COCB/

Date :

Ref No.: COCB/253 /2022-23

15<sup>th</sup> December 2022

## INTERNSHIP COMPLETION CERTIFICATE

This is to certify that SPOORTHI. R., Ref No. 20NCJC 884, B Com Final Year Student of The National College, Autonomous, Jayanagar, Bangalore has successfully completed internship of six weeks under the guidance of LAKSHMI N at this organization, towards fulfillment of the award of 'Bachelor of Commerce' during the year 2022-23

During the period of her internship she has exhibited punctuality and diligence. We wish her success in life.

Place: Bangalore

*Lakshmi*  
(Authorised signature with seal)

**N. LAKSHMI**  
Chief Manager / CEO



*D. Sush*  
PRINCIPAL  
The National College  
Jayanagar, Bangalore-70.





**PROJECT COMPLETION LETTER  
TO WHOMSOEVER TI MAY CONCERN**

This is to certify that Mr./ Ms. Spoorthi R bearing Reg. No 20NC.JC884 of B. Com VI Semester of the National College, Autonomous, Jayanagar, Bangalore has successfully completed the project work for the period of 4 weeks (10/04/2023-03/05/2023) under the guidance of (ABHISHEK & MANAGER) at our organization towards the fulfillment of award of "Bachelor of commerce" during the year 2023-2024.

The title of his/her project work was

**A STUDY ON ORGANIZATION BEHAVIOR.**

During the period of her project with us she has exhibited punctuality and diligence.

We wish her every success in life.

Thanking you.

For, EUREKA FORBES

Authorized signatory (with company seal)

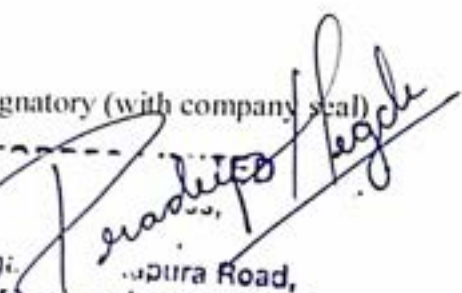
  
**EUREKA FORBES LIMITED**  
#1014, 2nd Floor,  
1st Main Road,  
S. S. Nagar, Chokkappa Road,  
Juganapur, Bangalore - 560062  
Ph: 6147

  
**Eureka Forbes Limited**

CIN: U27109WB1931PLC007010 Phone: (033) 3049 2534

Registered Office: 7, Chakra Beria Road, (South) Kolkata - 700025

PRINCIPAL  
**The National College**  
Jayanagar, Bangalore







19<sup>th</sup> Jul 2023

**TO WHOMSOEVER IT MAY CONCERN**

This is to certify that **Ms. Sinchana S Hegde**, a student of **The National College Autonomous, Jayanagar, Bangalore**. Pursuing **B. COM** has successfully completed the project with **Careernet Technologies Pvt. Ltd.**, for academic purposes.

**Below are the details of the project:**

Project Title: **Digital Hiring Process**

Project Duration: **22<sup>nd</sup> May 2023 to 13<sup>th</sup> Jun 2023**

We appreciate the efforts made by her for the project and extend our best wishes for her future endeavors.

For **Careernet Technologies Pvt. Ltd.**

**KAVITHA S**  
Digitally signed by KAVITHA S  
Date: 2023.07.20 17:02:31  
+05'30'

**Kavitha S**  
Vice President -HR

CONFIDENTIAL

*To. Sinchana*  
PRINCIPAL  
The National College  
Jayanagar, Bangalore-70

Corporate Office: Careernet Technologies Pvt. Ltd.  
Plot No 53, Kanyamana Agrahara Road, Mysore Road, Bangalore  
Outer Ring Road, Bellandur Post, Bangalore, 560103  
careernet.in





ದಿ ಮೈಸೂರ್ ಎಲೆಕ್ಟ್ರಿಕಲ್ ಇಂಡಸ್ಟ್ರೀಸ್ ಲಿಮಿಟೆಡ್

(ಕರ್ನಾಟಕ ರಾಜ್ಯ ಸರ್ಕಾರದ ಉದ್ಯಮ)

CIN NO. U85110KA1945SGC00037

THE MYSORE ELECTRICAL INDUSTRIES LIMITED  
(Government of Karnataka Undertaking)

REF: MEI/PER/02/F-343/2023

DATE : 02.05.2023

CERTIFICATE

This is to certify that Mr. SHISUVENK K B student of final year B.com bearing Reg No.:20NCJC882, student of The National College Autonomous Jayanagar, Bengaluru, affiliated to Bangalore University, Bangalore, he has successfully completed his Project in The Mysore Electrical Industries Limited starting from 1-4-2023 to 1-5-2023 at The Mysore Electrical Industries Limited, Bengaluru. During the period of his project with us he was found punctual, hardworking and his character was satisfactory.

This program on evaluation fulfils all the stated criteria. We wish him all the best.

For the Mysore Electrical Industries Limited.,

  
General Manager (A & HR)  
Deputy General Manager  
(Finance & Accounts)  
MEI Ltd., Bangalore

  
PRINCIPAL  
The National College  
Jayanagar, Bangalore-70.



ಲಿಜಸ್ಟರ್ ಅಫೀಸ್ : ತುಮಕೂರು ರಸ್ತೆ, ಯಶವಂತಪುರ, ಬೆಂಗಳೂರು-56 0022. REGD OFFICE: TUMKUR ROAD, YESHWANTHIPURA, BANGALORE-560 022 ದೂರವಾಣಿ / Phone 91-080-23374851 (6 Lines) 91-080-23386641 (3 Lines) ಫ್ಯಾಕ್ಸ್ / Fax: 91-080-23381811 ಅಂಚೆ ಪೆಟ್ಟಿಗೆ ಸಂಖ್ಯೆ / Post Box No. 2221 / ಬೆಂಗಳೂರು/BANGALORE-5600223 ಭಾರತ/ INDIA Email meimd@rediffmail.com, meilmatis9@gmail.com, meimktg@rediffmail.com

Visit us at www.meiswitchgears.org





ದಿ ಮೈಸೂರ್ ಎಲೆಕ್ಟ್ರಿಕಲ್ ಇಂಡಸ್ಟ್ರೀಸ್ ಲಿಮಿಟೆಡ್

(ಕರ್ನಾಟಕ ರಾಜ್ಯ ಸರ್ಕಾರದ ಉದ್ಯಮ)

CIN NO. U85110KA1945SGC00037

THE MYSORE ELECTRICAL INDUSTRIES LIMITED  
(Government of Karnataka Undertaking)

REF: MEI/PER/02/F-343/2023

DATE : 02.05.2023

CERTIFICATE

This is to certify that Mr. SHISUVENK K B student of final year B.com bearing Reg No.:20NCJC882, student of The National College Autonomous Jayanagar, Bengaluru, affiliated to Bangalore University, Bangalore, he has successfully completed his Project in The Mysore Electrical Industries Limited starting from 1-4-2023 to 1-5-2023 at The Mysore Electrical Industries Limited, Bengaluru. During the period of his project with us he was found punctual, hardworking and his character was satisfactory.

This program on evaluation fulfils all the stated criteria. We wish him all the best.

For the Mysore Electrical Industries Limited.,

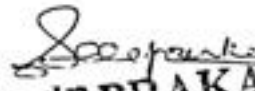
  
General Manager (A & HR)  
Deputy General Manager  
(Finance & Accounts)  
MEI Ltd., Bangalore

  
PRINCIPAL  
The National College  
Jayanagar, Bangalore-70.



ಲಿಜಸ್ಟರ್ ಅಫೀಸ್ : ತುಮಕೂರು ರಸ್ತೆ, ಯಶವಂತಪುರ, ಬೆಂಗಳೂರು-56 0022. REGD OFFICE: TUMKUR ROAD, YESHWANTHIPURA, BANGALORE-560 022 ದೂರವಾಣಿ / Phone 91-080-23374851 (6 Lines) 91-080-23386641 (3 Lines) ಫ್ಯಾಕ್ಸ್ / Fax: 91-080-23381811 ಅಂಚೆ ಪೆಟ್ಟಿಗೆ ಸಂಖ್ಯೆ / Post Box No. 2221 / ಬೆಂಗಳೂರು/BANGALORE-5600223 ಭಾರತ/ INDIA Email meimd@rediffmail.com, meilmatis9@gmail.com, meimktg@rediffmail.com

Visit us at www.meiswitchgears.org

Studio  
Unathi

Studio  
Unathi

ARCHITECTURE . INTERIORS . LANDSCAPE

## INTERNSHIP COMPLETION CERTIFICATE

This is to certify that **SHASHANK. K** Reg No.20NCJC881, B.Com  
Final Year student of The National College, Autonomous, Jayanagar, Bangalore has  
successfully completed internship of six weeks under the guidance of -  
**Mr. Supreeth. K. M** at this organization, towards the fulfillment of  
the award of 'Bachelor of Commerce' during the year 2022-23.

During the period of his/her internship he/she has exhibited punctuality and  
diligence. We wish his/her every success in life.

Date: 4/10/2022

Place: Bangalore

  
PRINCIPAL  
The National College  
Jayanagar, Bangalore-70.



#21, 1st Floor, VTB Layout, Madhura Nagar, Verthur-560087/ Contact: +91 9113282288



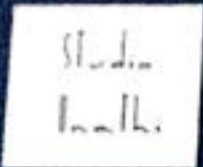

Studio  
Unathi

ARCHITECTURE . INTERIORS . LANDSCAPE

**PROJECT COMPLETION LETTER**

**TO WHOMSOEVER IT MAY CONCERN**

This is to certify that SHASHANK.K bearing Reg. No. 20NCJC881 of VI Semester B.Com student, The National College, Autonomous, Jayanagar, Bangalore has successfully completed the project work for the period of 04 weeks at STUDIO UNATHI under the guidance of Supreeth K. M at our organisation towards the fulfilment of the award of "Bachelor of Commerce" during the year 2023-24.

The title of his project work was "WORK LIFE BALANCE"

During the period of her project with us she has exhibited punctuality and diligence. We wish her every success in life.

Thanking you,



*[Signature]*  
PRINCIPAL  
The National College  
Jayanagar, Bangalore-70.





MK FASHION

MD 25 2/FLOOR CHUNDRAGATA MAIN ROAD  
PARKITEE TOKANANAPURA ROAD BANGALORE-560027  
9808 808 1111

Completion Certificate

This is to certify that **SARVAMANGALA TL Reg No.20NCJC879**, B.com Final year student of the National college, Autonomous, Jayanagar, Bangalore has successfully completed internship of six weeks under the guidance of MD Siddaraju at this organization, towards the fulfilment of the award of 'Bachelor of commerce' during the year 2022-23.

During the period of his/her internship he/she has exhibited punctuality and diligence. We wish his/her every success in life.

Authorized signature with seal

For M. K. FASHION

*Sidd*  
Proprietor

Date: 14/11/2022

Place: Bangalore

*D. Sush*  
PRINCIPAL  
The National College  
Jayanagar, Bangalore-70







FULLERTON INDIA CREDIT CO LTD

Shivanna Complex 1st Floor  
Malagala main Road, near  
Chamundeswari Binny Rice Mill,  
Rama Durga, Kanakapura, Karnataka 562117  
Mobile No:8792290949

**PROJECT COMPLETION LETTER**

**TO WHOMSOEVER IT MAY CONCERN**

This is to certify that Mr./Ms. SARVAMANGALA TL bearing Reg.No.20NCJC879 of VI Semester B. Com student, The National College, Autonomous, Jayanagar, Bangalore has successfully completed the project work for the period of 04 weeks (01/04/2023 – 28/04/2023) under the guidance of (SIDDARAJU K R & MANAGER) at our organisation towards the fulfilment of award of "Bachelor of Commerce" during the year 2023-24.

The title of his/her project work was

**A PROJECT REPORT ON LOANS AND SECURITY DOCUMENTATION IN FULLERTON INDIA CREDIT Co. Ltd.**

During the period of his/her project with us he/she has exhibited punctuality and diligence. We wish him/her every success in life.

Thanking you.

For, **FULLERTON INDIA CREDIT Co. Ltd.**

Fullerton India Credit  
Company Ltd

Authorised signatory with company seal

PRINCIPAL  
The National College  
Jayanagar, Bangalore-70.



03-11-2022

To,  
Dr. N K Satya Pal Sharma  
HOD- Department of Commerce  
The National College  
Autonomous  
Jayanagar, Bangalore-70

Dear Sir,

Subject: Internship Acceptance Letter- Ramya shree R 20NCJC878

This is to certify that Ms. Ramya shree R Reg No. 20NCJC878 has joined in our organisation on 07-10-2022 and she will be working as internship trainee in Mukta A2 Cinemas for the period of 45 days.

Thanking you



*[Handwritten Signature]*

PRINCIPAL

The National College  
Jayanagar, Bangalore-70.



**MUKTA A2 CINEMAS LIMITED**

Head Office: Mukta House, Behind Whistling Woods Institute, Filmcity Complex, Goregaon (East), Mumbai - 400065

Telephone No. : (022) 33649400 | Fax No. - (022) 33649401 | CIN: U74999MH2016PLC287694

www.muktaa2cinemas.com | Follow us on  /muktaA2cinemas



**TO WHOMSOEVER IT MAY CONCERN**

This is to certify that Miss RAMYASHREE.R bearing Reg. No.20NCJC878 of VI Semester B.Com student, The National College, Autonomous, Jayanagar, Bangalore has successfully completed the project work for the period of 04 weeks 05-04-2023 TO 05-05-2023 under the guidance of Anjanappa V, Senior Talent Acquisition at our organisation towards the fulfilment of award of "Bachelor of Commerce" during the year 2022-23.

The title of her project work was "Work life balance and employee engagement activities".

During the period of her project with us she has exhibited punctuality and diligence. We wish her every success in life.

Thanking you.



Anji V  
Senior - TA & Campus Relation  
Bangalore & RoK  
Mobile +91 9611995988  
<http://www.byjus.com/>

  
PRINCIPAL  
The National College  
Jayanagar, Bangalore-70



THINK & LEARN PRIVATE LIMITED  
IBC KNOWLEDGE PARK, 4/12 FLOOR, TOWER D  
BANNERGHATTA MAIN ROAD, BENGALURU-  
560029, KARNATAKA  
E-MAIL: [INFO@BYJUS.COM](mailto:INFO@BYJUS.COM) / TEL NO: +91 80668 36800  
CIN U80903KA2011PTC061427  
[WWW.BYJUS.COM](http://WWW.BYJUS.COM)



DelexCargoIndiaPrivateLimited

F5, 5th Floor 4 &  
5, Pinnacle Business Park,  
Mahakali Caves Road,  
Andheri (East),  
Mumbai 400093, India.  
[www.delex.in](http://www.delex.in)

Acceptance letter

Date :10/10/2022

To,  
Dr.N K Sataya Pal Sharma  
HOD-Department of Commerce  
The National College  
Autonomous  
Jayanagar, Bangalore-70

DEAR Sir,

Subject : Internship ACCEPTANCE LETTER - Puneeth.J, 20NCIC877

This is to certify that Mr. Puneeth.J Reg.No.20NCI877 joined our organization on 4/10/2022 and he will be working as an internship trainee in our DELEX CARGO Private Limited For 45days.

Thankyou

Your regards.

JYOTHIPRASADTS

Operationmanager



PRINCIPAL  
The National College  
Jayanagar, Bangalore-70.





**Lenskart Solutions Pvt. Ltd.**

12/1, 7<sup>th</sup> Floor, Vastika Mundscapes, National Highway 2  
Sector 27D, Faridabad, Haryana - 121003 | www.lenskart.com  
CIN: U31494DL2008PTC178355



**PROJECT COMPLETION LETTER**

**TO WHOMSOEVER IT MAY CONCERN**

This is to certify that Mr./Ms. **PUNEETH J** bearing Reg. No. **20NCJC877** of VI Semester B.Com student, The National College, Autonomous, Jayanagar, Bangalore has successfully completed the project work for the period of 06 weeks (12/05/2023 to 23/06/2023) under the guidance of (**VINAY KUMAR J - Logistic Manager**) at our organisation towards the fulfilment of award of "Bachelor of Commerce" during the year 2022-23.

The title of his/her project work was **Forward and Reverse Logistics in Lenskart.**

During the period of his/her project with us he/she has exhibited punctuality and diligence. We wish him/her every success in life.

Thanking you.

For,

Lenskart Team (KRS1850)  
Ground Floor, Dr. M. V. Road,  
Hullimavu, 1<sup>st</sup> Stage, 2nd Block  
BTM, Bangalore - 560078

Authorised signatory with company seal

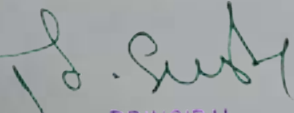
  
PRINCIPAL  
The National College  
Jayanagar, Bangalore-70





ದಿ ಮೈಸೂರ್ ಎಲೆಕ್ಟ್ರಿಕಲ್ ಇಂಡಸ್ಟ್ರೀಸ್ ಲಿಮಿಟೆಡ್

(ಕರ್ನಾಟಕ ರಾಜ್ಯ ಸರ್ಕಾರದ ಉದ್ಯಮ)

CIN NO. U85110KA1945SGC00037  
THE MYSORE ELECTRICAL INDUSTRIES LIMITED  
(Government of Karnataka Undertaking)

REF: MEI/PER/02/F-345/2023

DATE : 02.05.2023

CERTIFICATE

This is to certify that Mr. PRAVEEN K P student of final year B.com bearing Reg No.:20NCJC876, student of The National College Autonomous Jayanagar, Bengaluru, affiliated to Bangalore University, Bangalore, he has successfully completed his Project in The Mysore Electrical Industries Limited starting from 1-4-2023 to 1-5-2023 at The Mysore Electrical Industries Limited, Bengaluru. During the period of his project with us he was found punctual, hardworking and his character was satisfactory.

This program on evaluation fulfils all the stated criteria. We wish him all the best.

For the Mysore Electrical Industries Limited.,

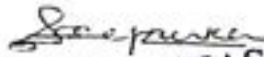
  
General Manager (A & HR)  
S. JAI PRAKASH  
Deputy General Manager  
(Finance & Accounts)  
MEI Ltd., Bangalore

  
PRINCIPAL

The National College  
Jayanagar, Bangalore-70.



ರಜಿಸ್ಟರ್ಡ್ ಅಫೀಸ್ : ನುಮಕೂರು ರಸ್ತೆ, ಯಶವಂತಪುರ, ಬೆಂಗಳೂರು-56 0022. REGD OFFICE: YESHWANTHPURA, BANGALORE-560 022 ದೂರವಾಣಿ / Phone 91-080-23374851 (6 Lines) 91-080-23386641 (3 Lines) ಫ್ಯಾಕ್ಸ್ / Fax: 91-080-23381811 ಅಂಚೆ ಪೆಟ್ಟಿಗೆ ಸಂಖ್ಯೆ / Post Box No. 2221 / ಬೆಂಗಳೂರು/BANGALORE-5600223 ಭಾರತ / INDIA Email meimd@rediffmail.com, meimatis9@gmail.com, meimktg@rediffmail.com  
Visit us at www.meiswitchgears.org





ದಿ ಮೈಸೂರ್ ಎಲೆಕ್ಟ್ರಿಕಲ್ ಇಂಡಸ್ಟ್ರೀಸ್ ಲಿಮಿಟೆಡ್

(ಕರ್ನಾಟಕ ರಾಜ್ಯ ಸರ್ಕಾರದ ಉದ್ಯಮ)

CIN NO. U85110KA1945SGC00037  
THE MYSORE ELECTRICAL INDUSTRIES LIMITED  
(Government of Karnataka Undertaking)

REF: MEI/PER/02/F-345/2023

DATE : 02.05.2023

CERTIFICATE

This is to certify that Mr. PRAVEEN K P student of final year B.com bearing Reg No.:20NCJC876, student of The National College Autonomous Jayanagar, Bengaluru, affiliated to Bangalore University, Bangalore, he has successfully completed his Project in The Mysore Electrical Industries Limited starting from 1-4-2023 to 1-5-2023 at The Mysore Electrical Industries Limited, Bengaluru. During the period of his project with us he was found punctual, hardworking and his character was satisfactory.

This program on evaluation fulfils all the stated criteria. We wish him all the best.

For the Mysore Electrical Industries Limited.,

  
General Manager (A & HR)  
S. JAI PRAKASH  
Deputy General Manager  
(Finance & Accounts)  
MEI Ltd., Bangalore

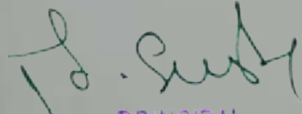
  
PRINCIPAL  
The National College  
Jayanagar, Bangalore-70



**SRV RETAIL**

Office : # 19, Platform Road  
Seshadripuram  
Bengaluru - 560 020  
Tel : 080-23566055

**INTERNSHIP COMPLETION CERTIFICATE**

This is to certify that Mr.PRATHAP L, Reg No.20NCJC875, B.Com Final Year student of The National College, Autonomous, Jayanagar, Bangalore has successfully completed internship of 12 days under the guidance of Mr Ashok Savanth (Store Manager)at this organization (*Tanishq Bannerghatta Road*), towards the fulfillment of the award of '*Bachelor of Commerce*' during the year 2022-23.

During the period of his/her internship he/she has exhibited punctuality and diligence. We wish his/her every success in life.

(Authorized signature with seal)

Date:

Place:

  
PRINCIPAL  
The National College  
Jayanagar, Bangalore-70.





## INTERNSHIP COMPLETION CERTIFICATE

This is to certify that Ms. NIKITHA K, Reg No. 20NCJC874, B.Com Final Year student of The National College, Autonomous, Jayanagar, Bangalore has successfully completed internship of 14 days under the guidance of Mr Ashok Savanth (Store Manager) at this organization (*Tanishq Bannerghatta Road*), towards the fulfillment of the award of 'Bachelor of Commerce' during the year 2022-23.

During the period of his/her internship he/she has exhibited punctuality and diligence. We wish his/her every success in life.

  
(Authorized signature with seal)



Date:

Place:

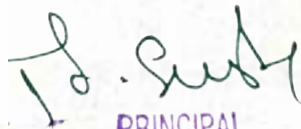
  
PRINCIPAL  
The National College  
Jayanagar, Bangalore-70.





HMT (International) Limited  
A Government of India Enterprise



## PROJECT COMPLETION LETTER

### TO WHOMSOEVER IT MAY CONCERN

This is to certify that Mrs. Nikitha K bearing Reg No. 20NCJC874 of VI Semester B.Com student, The National College, Autonomous, Jayanagar, Bangalore has successfully completed the project work for the period of 06 weeks from 08.04.2023 to 27.06.2023 Under Arun Kumar, Executive Head, at our organisation towards the fulfilment of award of "Bachelor of Commerce" during the year 2022-2023.

The title of her project work was Financial Performance analysis.

Her roles and responsibilities included that of Audit Associate. During the Project program with us she was found to be hardworking and efficient. We wish her lots of success in all her upcoming endeavours.

Thanking You.

HMT (International) Limited



Authorised signatory with company seal

*[Signature]*  
PRINCIPAL  
The National College  
Jayanagar, Bangalore-70.







## INTERNSHIP COMPLETION CERTIFICATE.

This is to certify that Mr. Mohan N Reg No. 20NCJC873 B.Com Final Year student of The National College, Autonomous, Jayanagar, Bangalore has successfully completed internship of six weeks under the guidance of Praveen Kumar (Technical architect) at this organization, towards the fulfillment of the award of 'Bachelor of Commerce' during the year 2022-23.

During the period of his internship he has exhibited punctuality and diligence. We wish his every success in life.

*[Handwritten signature]*



Date:  
Place:

*[Handwritten signature]*  
PRINCIPAL

The National College  
Jayanagar, Bangalore-70.  
Corporate Office: 11 B2, Lakshmi Krushna, 1st Floor, 1st Street, Choolamedu, Chennai-600029  
Web: [eyefocus.com](http://eyefocus.com) Email: [info@eyefocus.com](mailto:info@eyefocus.com)



GSTIN : 29ABPFS9730F1ZK



Mob : 98803 02804  
98805 42001

## S.L.V. CORRUGATORS

**Manufacture of Heavy Duty Shipper and Corrugated Boxes**

Survey no. 79, Near KRB Indian Oil Petrol Pump, J.P.Nagar, 9 th Phase, Anjanapura Post,  
Bangalore - 560 108. Email : slv\_blr@hotmail.com

Ref.

PROJECT COMPLETION LETTER

Date : 29/04/2023

This is to certify that Mr. MOHAN N bearing Reg.No.20NCJC873 of VI Semester B.Com student, The National College, Autonomous, Jayanagar, Bangalore has successfully completed the project work for the period of 04 weeks (03/04/2023 to 29/04/2023) under the guidance of RAMU S Manager at our organisation towards the fulfilment of award of "Bachelor of Commerce" during the year 2022-23.

The title of his project work was Supply chain management process.

During the period of his project with us he has exhibited punctuality and diligence. We wish him every success in life.

Thanking you.



*[Handwritten Signature]*  
PRINCIPAL  
The National College  
Jayanagar, Bangalore-70





## INTERNSHIP COMPLETION CERTIFICATE

This is to certify that **Ms. Meena.V, Reg No. 20NCJC872**, B.Com Final Year student of The National College, Autonomous, Jayanagar, Bangalore has successfully completed internship on Recruitment and Documentation from 15/09/2202 to 30/10/2022 of under the guidance of **ABHISHEK**, in Eureka Forbes towards the fulfillment of the award of '*Bachelor of Commerce*' during the year **2022-23**.

During the period of his internship, he has exhibited punctuality and diligence. We wish his every success in life.



Yours Sincerely

*Abhi*  
**EUREKA FORBES LIMITED**  
#1014, 2nd Floor, 2nd Cross,  
1st Main, Near...

*D. Sush*  
**PRINCIPAL**  
**The National College**  
Jayanagar, Bangalore-70.





TO WHOMSOEVER IT MAY CONCERN

This is to certify that Ms.Meena, V bearing Reg.No. 20NCJC872 of VI Semester B.Com student, The National College, Autonomous, Jayanagar, Bangalore has successfully completed the project work for the period of 6 weeks, From 15/05/2023 to 17/06/2023 under the guidance of (JULIE GONSALVAS, MARKETING HEAD) at our organisation towards the fulfilment of award of "Bachelor of Commerce" during the year 2022-23.

The title of her project work was Impact of branding on consumer purchasing behavior with Reliance Trends

During the period of her project with us she has exhibited punctuality and diligence. We wish her every success in life.

Thank you.

For,  
Reliance Trends

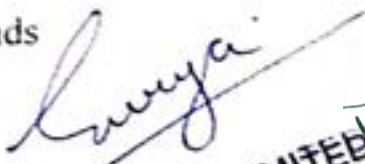
  
RELiance RETAIL LIMITED  
Bhartiya City Fr...  
Bangalore, Karnataka - 560 077  
PRINCIPAL  
The National College  
Jayanagar, Bangalore-70







F5, 5th Floor -4  
&5,PinnacleBusiness  
sP  
ark.Mahakali  
CavesRoad,  
Andheri(East).  
Mumbai-  
400093.India.  
[www.delex.in](http://www.delex.in)

**DelexCargoIndiaPrivateLimited**

### INTERNSHIP COMPLETION CERTIFICATE

This is to certify that **MANJU H** Reg No.20NCJC871, B.COM Final Year student of The National College, Autonomous, Jayanagar, Bangalore has successfully completed internship of six weeks under the guidance of **JYOTHI PRASAD** at this organization, towards the fulfillment of the ward of 'Bachelor of Commerce' duringtheyear2022-23.

During the period of his/her internship he/she has exhibited punctuality and diligence. We wish his/her every success in life.

DATE:21/11/2022

Thankyou

Yourregards.

JYOTHIPRASADTS



Operationmanager

PRINCIPAL  
The National College  
Jayanagar, Bangalore-70.



871



## PROJECT COMPLETION LETTER

### TO WHOMSOEVER IT MAY CONCERN

This is to certify that Mr. **MANJU H** bearing Reg. No. **20NCJC871** of VI Semester B.Com student, The National College, Autonomous, Jayanagar, Bangalore has successfully completed the project work for the period of 06 weeks (**20/04/2023 to 20/5/2023**) under the guidance of (**Sridhar GDM Dominos pizza**) at our organisation towards the fulfilment of award of "Bachelor of Commerce" during the year 2023-2024.

The title of his project work was Importance of brand choice attributes for dominos pizza.

During the period of his project with us he has exhibited punctuality and diligence. We wish him every success in life.

Thanking you.

Authorised signatory (Domino's Pizza)  
Jubilant Foods Ltd Factory with No. 36  
(DP87052) Ground Floor, Company seal  
Horatur Main Road, Haralur Village  
Off Sarjapur Main Road  
Bangalore - 560 102, Karnataka

*[Signature]*  
PRINCIPAL  
The National College  
Jayanagar, Bangalore-70.



A jubilant Bhartia company  
Jubilant Foodworks Limited  
Corporate office  
5th floor, Tower-D plot No 5  
Logix techno park, Sector-127,  
Noida-201 304 UP India

guestcareDominos@jubilantfood.com



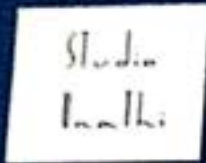

**Studio  
Unathi**

ARCHITECTURE . INTERIORS . LANDSCAPE

**ACCEPTANCE LETTER**

Date: 23/09/2022

To  
Dr. N K Satya Pal Sharma  
HOD- Department of Commerce  
The National College  
Autonomous  
Jayanagar, Bangalore- 70

STUDIO

Dear Sir,

**Subject: Internship Acceptance Letter – MANOJ. H (20NCJC870)**

This is to certify that Mr./Ms. **MANOJ. H** Reg. No. **20NCJC870** has joined in our organisation on 23/09/2022 and he/she will be working as internship trainee in Studio Unathi for the period of 45 days.

Unathi

Thanking You

With Regards

From

Supreeth. K. M (General Manager)



Authorized Signatory/Company's Seal

Signature  
6/10/2022

*[Signature]*  
PRINCIPAL

#21, 1st Floor, VTB Layout, Maitheera Nagar, Varthur-560087/ Contact: 919113252268  
The National College  
Jayanagar, Bangalore-70





ದಿ ಮೈಸೂರ್ ಎಲೆಕ್ಟ್ರಿಕಲ್ ಇಂಡಸ್ಟ್ರೀಸ್ ಲಿಮಿಟೆಡ್

(ಕರ್ನಾಟಕ ರಾಜ್ಯ ಸರ್ಕಾರದ ಉದ್ಯಮ)

CIN NO. U85110KA1945SGC00037

THE MYSORE ELECTRICAL INDUSTRIES LIMITED  
(Government of Karnataka Undertaking)

REF: MEI/PER/02/F-341/2023

DATE : 02.05.2023

CERTIFICATE

This is to certify that Mr. MANOJ H student of final year B.com bearing Reg No.:20NCJCS70, student of The National College Autonomous Jayanagar, Bengaluru, affiliated to Bangalore University, Bangalore, he has successfully completed his Project in The Mysore Electrical Industries Limited starting from 1-4-2023 to 1-5-2023 at The Mysore Electrical Industries Limited, Bengaluru. During the period of his project with us he was found punctual, hardworking and his character was satisfactory. This program on evaluation fulfils all the stated criteria. We wish him all the best.

For the Mysore Electrical Industries Limited.,

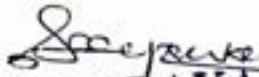
  
S. J. PRAKASH  
Deputy General Manager (A & HR)  
(Finance & Accounts)  
MEI Ltd., Bangalore

  
PRINCIPAL  
The National College  
Jayanagar, Bangalore-70.



ರಿಸರ್ಚ್ ಅಫೀಸ್ : ತುಮಕೂರು ರಸ್ತೆ, ಯಶವಂತಪುರ, ಬೆಂಗಳೂರು-56 0022 REGD OFFICE: TUMKUR ROAD, YESHWANTHPURA, BANGALORE-560 022 ದೂರವಾಣಿ / Phone 91-080-23374851 (6 Lines) 91-080-23386641 (3 Lines) ಫ್ಯಾಕ್ಸ್ / Fax: 91-080-23381811 ಅಂಚೆ ಪೆಟ್ಟಿಗೆ ಸಂಖ್ಯೆ / Post Box No. 2221 / ಬೆಂಗಳೂರು/BANGALORE-5600223 ಭಾರತ/ INDIA Email meimd@rediffmail.com, meimatis9@gmail.com, meimktg@rediffmail.com Visit us at www.meiswitchgears.org



## INTERNSHIP COMPLETION CERTIFICATE

This is to certify that Mr.MANOJ C, Reg No.20NCJC869, B.Com Final Year student of The National College, Autonomous, Jayanagar, Bangalore has successfully completed internship of 12 days under the guidance of Mr Ashok Savanth (Store Manager)at this organization (*Tanishq Bannerghatta Road*), towards the fulfillment of the award of '*Bachelor of Commerce*' during the year 2022-23.

During the period of his/her internship he/she has exhibited punctuality and diligence. We wish his/her every success in life.

(Authorized signature with seal)

Date:

Place:

  
PRINCIPAL  
The National College  
Jayanagar, Bangalore-70.



**Reliancedigital**

This is to certify that **Mr. MANOJ.C** bearing Register No.20NCJC869, B.Com final year student, **The National College, Autonomous, Jayanagar, Bangalore** has successfully completed a Project of four weeks (from 15/04/2022 to 13/05/2022) under the guidance of (**Mr.RAHUL KULKARNI, STORE MANAGER**) at this outlet, towards the fulfillment of award of "Bachelor of Commerce" during the year 2022 – 2023.

The title of his project work was **CONSUMER PREFERENCE AND STORE IMAGE.**

During the period of his Project he has exhibited punctuality and diligence. We wish him/her every success in life.

Date :20/05/2023  
Place:Bangalore



Authorized Signature

*[Handwritten Signature]*  
PRINCIPAL  
The National College  
Jayanagar, Bangalore-70.



#5 #5, No 12/1 & 6/5, Ground & First floor, Siddaganga Math, Kanakapura road, Bangalore-560062  
Phone: 080 2842 7663, 7996321531, Email: happy@reliancedigital.com  
Website: [www.reliancedigital.com](http://www.reliancedigital.com)





MK FASHION

MD SIDDARAJU  
SARAJEYU TO BILAKALP K. S. POND BAPPAJI HITE, HAWA  
1008, 1048, 1111

### Completion Certificate

This is to certify that **LEELAMBIKE C** Reg No.20NCJC867, B.com Final year student of the National college, Autonomous, Jayanagar, Bangalore has successfully completed internship of six weeks under the guidance of MD Siddaraju at this organization, towards the fulfilment of the award of 'Bachelor of commerce' during the year 2022-23.

During the period of his/her internship he/she has exhibited punctuality and diligence. We wish his/her every success in life.

Authorized signature with seal

for M. K. FASHION

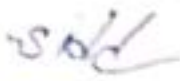
  
Proprietor

  
PRINCIPAL  
The National College  
Jayanagar, Bangalore-70.



Date: 14/11/2022

Place: Bangalore

## TO WHOMSOEVER IT MAY CONCERN

This is to certify that Mr./Ms. LEE LAMBIKE C bearing Reg. No. 20NCJC867 of VI Semester B.Com student, The National College, Autonomous, Jayanagar, Bangalore has successfully completed the project work for the period of 06 weeks (03/04/2023 to 15/05/2023 ) under the guidance of RADHAKRISHINA RAO .K ( MANAGER ) at our organisation towards the fulfilment of award of "Bachelor of Commerce" during the year 2022-23

The title of his/her project work was A Project report on Logistics and warehouse management in Honeywell technology solutions.

During the period of his/her project with us he/she has exhibited punctuality and diligence. We wish him/her every success in life.

Thanking you.

For,

**HONEYWELL TECHNOLOGY SOLUTIONS LAB PVT LTD.**

*Radhakrishna*  
Authorised signatory with company seal  
  
PRINCIPAL  
The National College  
Jayanagar, Bangalore-70.





Date: 02/11/2022

**INTERNSHIP COMPLETION CERTIFICATE**

This is to certify that **Mr. T. KUSHAAL SIDDHA** Reg No. **20NCJC866**, B.Com Final Year student of The National College, Autonomous, Jayanagar, Bangalore has successfully completed internship of six weeks under the guidance of **SRIDHAR RAO S** at this organization, towards the fulfillment of the award of 'Bachelor of Commerce' during the year 2022-23.

During the period of his internship he has exhibited punctuality and diligence. We wish his every success in life.

For Davanam Jewellerys Pvt Ltd



Authorized Signatory

  
PRINCIPAL

The National College  
Jayanagar, Bangalore-70



Head Office : No. 8, Kamaraj Road, Commercial Street junction, Bangalore-560 002. Phone : 4141 8181 (33 Lines) Fax : 4141 8151  
Regional Office : Malleswaram : # 10, AB Arcade, West Park Road, 8th Cross, Malleswaram, Bangalore - 560 003. Phone : 4343 8383 Fax : 4343 8328  
Branch Offices: Avenue Road, # 506, 507, Avenue Road, Bengaluru - 560 002. Phone : 4141 6161 (33 Lines) Fax : 4141 6151  
Email : sales@davanam.com Website : www.davanam.com  
CIN - UJ36911KA2005PTCO35963

## PROJECT COMPLETION LETTER

DATE: 8 JUNE 23

### TO WHOMSOEVER IT MAY CONCERN

This is to certify that Mr. KUSHAAL SIDDHA T bearing Reg. No. 20NCJC866 of VI Semester B. Com student, The National College, Autonomous, Jayanagar, Bangalore has successfully completed the project work for the period of 06 weeks on 24 APRIL 2023 to 8 JUNE 2023 under the guidance of MANAGER at our organisation towards the fulfilment of award of "Bachelor of Commerce" during the year 2022-23.

The title of his project work was "A PROJECT ON STRESS MANAGEMENT AND CONFLICT RESOLUTIONS".

During the period of his project with us he has exhibited punctuality and diligence. We wish him every success in life.

Thanking you.

For, WONFIN SOLUTIONS.



WONFIN SOLUTIONS  
Bangalore

Authorised signatory

  
D. Sush  
PRINCIPAL  
The National College  
Jayanagar, Bangalore-70.





**SRSV AGRO COMPANY**

# 8/69, 'Prabhat Complex'  
Kempegowda Road  
Bengaluru - 560 009

**INTERNSHIP COMPLETION CERTIFICATE**

This is to certify that Ms. Kavya N, Register No.20NCJC865, B.com Final Year student of The National College, Autonomous, Jayanagar, Bangalore has Successfully Completed Internship of 10 days Under the Guidance of At Tanishq Caratlane Jayanagar, Towards the fulfillment of the award of 'Bachelor of Commerce' during the year of 2022 - 23.

During the period of her internship she exhibited punctuality and diligence. We wish her every success in life.

Date :02/11/2022

Place:Bangalore

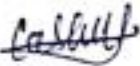

Hr-Executive

Tanishq Jayanagar



PRINCIPAL

The National College  
Jayanagar, Bangalore-70.



Show Room : No. 83/2, 9th Main Road, 4th Block, Jayanagar, BENGALURU - 560 011  
Mob : 7338273383

## PROJECT COMPLETION LETTER

DATE: 23/05/23

### TO WHOMSOEVER IT MAY CONCERN

This is to certify that Ms. KAVYA N bearing Reg. No. 20NCJCB65 of VI Semester B.Com student, The National College, Autonomous, Jayanagar, Bangalore has successfully completed the project work for the period of 06 weeks on 22 MAY 2023 under the guidance of SMITHA Human resources TATA AIG at our organisation towards the fulfilment of award of "Bachelor of Commerce" during the year 2022-23.

The title of her project work was "A PROJECT REPORT ON HEALTH INSURANCE AT TATA AIG".

During the period of her project with us she has exhibited punctuality and diligence. We wish her every success in life.

Thanking you.

For, TATA AIG

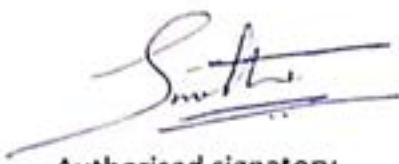

Authorised signatory

  
PRINCIPAL  
The National College  
Jayanagar, Bangalore-70.







# Swemed Biomedicals Pvt. Ltd.

29/1 first floor, Chunchanaghatta Cross, Yelachenahalli, Bengaluru 560062

## INTERNSHIP COMPLETION CERTIFICATE

This is to certify that S.JAYANTH, Reg No. 20NCJC864, B.Com Final Year student of The National College, Autonomous, Jayanagar, Bangalore has successfully completed internship of six weeks under the guidance of – K.KUMAR SHARMA, at this organization, towards the fulfillment of the award of 'Bachelor of Commerce' during the year 2022-23.

During the period of his internship he has exhibited punctuality and diligence. We wish his every success in life.

Yours Sincerely

For Swemed Biomedicals Pvt. Ltd.

For SWEMED BIOMEDICALS PVT. LTD

Kumar  
Authorized signatory  
K KUMAR SHARMA,  
HR MANAGER

D. Sush  
PRINCIPAL  
The National College  
Jayanagar, Bangalore-70.



**TO WHOMSOEVER IT MAY CONCERN**

This is to certify that Mr. S.JAYANTH bearing Reg. No 20NCIC864 of VI Semester B.Com student, The National College, Autonomous, Jayanagar, Bangalore has successfully completed the project work for the period of 06 weeks 2/5/2023 to 30/5/2023 under the guidance of **JAGGA REDDY – MARKETING HEAD** at our organisation towards the fulfilment of award of "Bachelor of Commerce" during the year 2021-22.

The title of his project work was Effect of sales forecast on marketing decision making

During the period of his project with us he has exhibited punctuality and diligence. We wish him every success in life.

Thanking you.



Authorised signatory with company seal

  
PRINCIPAL  
The National College  
Jayanagar, Bangalore-70.







# Toyotetsu India Private Limited

TTIA/HRD/Std-PJT./2022-23

Date: 27.09.2022

Dr. N K Satya Pal Sharma  
Head – Department of Commerce,  
The National College,  
Jayanagar, Bangalore-560 070

Dear Sir,

**Subject: Permission to your student to carry out Internship in our organization.**  
**Reference: Letter from college dated 20.09.2022**

With respect to the subject matter & request letter dt. 20.09.2022 seeking permission to carry out Internship at our organization has been examined and we are pleased to inform you that the permission has been accorded to your student **Ms. Gouthami M (Reg No: 20NCJC863)** to carry out Internship program for the period of 6 weeks starting from 27<sup>th</sup> Sep 2022 on daily basis.

During the training period, student must report to **Finance & Accounts Department** without fail on daily basis. At the end of the internship program, student must submit a detailed report on her study to the management. Student, while collecting data for her internship program such as balance sheet / financials, photos, write-ups etc., she must obtain necessary permission from the concerned authority. Data collected from our organization must be used for academic purposes only.

Company will be provided with subsidized canteen facility to the trainee. We at TTIA regard Safety attitude as important discipline and every individual must follow all Safety norms without fail at all times.

Student trainee have to abide by all the Rules & Regulations of the company during the training period, also must and should carry college ID card every day. Failing which this permission will be curtailed without any communication.

Thanking you.

For Toyotetsu India Pvt. Ltd.

  
Umashankar K  
GM – HR, IR & Admin.

  
PRINCIPAL  
The National College  
Jayanagar, Bangalore-70.



Toyota Techno Park, Plot No. 20, Bldg. No 2, Bidadi Industrial Area, Bidadi,  
Ramanagar District - 562 109, Karnataka, India.  
Ph. : +91-80-27287158 / 159 / 174 / 175 Fax : +91-80-27287153  
CIN : U34300KA1998PTC024464



**A-RAVI RAG INDUSTRIES**

**TO WHOMSOEVER IT MAY CONCERN**

This is to certify that MS.GAUTHAMI M bearing Reg. No. 20NCJC863 of VI Semester B.Com student, The National College, Autonomous, Jayanagar, Bangalore has successfully completed the project work for the period of 04 weeks under the guidance of Mr. THULASI KUMAR at our organization towards the fulfilment of award of "Bachelor of Commerce" during the year 2022-23.

The title of his project work was

During the period of his project with us he has exhibited punctuality and diligence. We wish Her every success in life.

Thanking you.

**A-Ravi Rag industries**

*[Handwritten Signature]*

**PRINCIPAL**

**The National College  
Jayanagar, Bangalore-70**



*[Handwritten Signature]*





Reg - 862

**Fortis Hospitals Limited**  
154/9, Bannerghatta Road,  
Opp. IIM-B, Bangalore - 560 076  
Tel. : +91-80-6621 4444, 2254 4444  
Fax : +91-80-6621 4242.  
care.bng@fortishealthcare.com  
CIN No. U93000DL2009PLC222166

21<sup>st</sup> November 2022

**TO WHOMSOEVER IT MAY CONCERN**

This is to certify that Ms. Divya N , B.Com Student of The National College has successfully completed her "Internship in Finance Department" at Fortis Hospital Ltd, Bangalore from 07<sup>th</sup> October 2022 to 21<sup>st</sup> November 2022.

We wish Ms. Divya N all success in her future endeavors.

For Fortis Hospital Limited

Sharath H  
Deputy Manager- HR



PRINCIPAL  
The National College  
Jayanagar, Bangalore-70.



24\*7 **EMERGENCY HELP LINE 96860 96860**



TO WHOMSOEVER IT MAY CONCERN

This is to certify that Ms. Divya.N. bearing Reg. No. No.20ncjc862 of VI Semester B.Com student, The National College, Autonomous, Jayanagar, Bangalore has successfully completed the project work for the period of 06 weeks (02-5-2023 to 30-05-2023) under the guidance of Mr.R.G.M.VASANTH, Store-Manager, at our organisation towards the fulfilment of award of "Bachelor of Commerce" during the year 2022-23.

The title of her project work was "Competitive advantage of business success".

During the period of his/her project with us she has exhibited punctuality and diligence. We wish her every success in life.

Thanking you.

For Burger king

Authorised signatory  
BURGER KING INDIA LIMITED  
Unit No. 1001B & T007,  
Royal Meenakshi Mall, 3rd Floor,  
Opp. Meenakshi Temple Hulimavu,  
Bannerghatta Road, Bangalore - 56007

*Pantlik*

*D. Sush*  
PRINCIPAL  
The National College  
Jayanagar, Bangalore-70





## INTERNSHIP COMPLETION CERTIFICATE

This is to certify that Mr.DHEERAJ CK, Reg No.20NCJCS61, B.Com Final Year student of The National College, Autonomous, Jayanagar, Bangalore has successfully completed internship of 11 days under the guidance of Mr Ashok Savanth (Store Manager) at this organization (*Tanishq Bannerghatta Road*), towards the fulfillment of the award of 'Bachelor of Commerce' during the year 2022-23.

During the period of his/her internship he/she has exhibited punctuality and diligence. We wish his/her every success in life.

  
(Authorized signature with seal)



Date:

Place:

  
PRINCIPAL  
The National College  
Jayanagar, Bangalore-70.





PROJECT COMPLETION LETTER

Date:18/05/2023

TO WHOMSOEVER IT MAY CONCERN

This is to certify that Mr. Dheeraj Ck bearing Reg. No. 20NCIC861 of VI Semester B.Com student, The National College, Autonomous, Jayanagar, Bangalore has successfully completed the project work for the period of 04 weeks 18.04.2023 to 18.05.2023 under the senior guidance at our organisation towards the fulfilment of award of "Bachelor of Commerce" during the year 2022-23.

The title of his project work was A Study on the impact of impact sale's promotion Of 3M

The project completion certificate will be issued to the student after submission of

The project report to organisation.

Thanking you

3M



3M VHB Tapes Technical Support

No.41, HMT Factory Main Road,

next to HMT School

  
PRINCIPAL  
The National College  
Jayanagar, Bangalore-70.





TIN : 29440208029  
GSTIN : 29ALIPK7776Q12W



Mob: 9739710814

# ARUNACHALAM TRADERS

Dealers in : Wholesale & Retail Tea Powder, Suppliers of Assam, Darjiling, Nilgiri Tea & Spices  
# 6, Old Tharagupet Cross, G.S. Market, 1st Floor, Bangalore-560 053.

Date.....

Ref:

## INTERNSHIP COMPLETION CERTIFICATE

This is to certify that DHANU KUMAR. K Reg No.20NCJC860 B.Com Final Year student of The National College, Autonomous, Jayanagar, Bangalore has successfully completed internship of six weeks under the guidance of -PREM KUMAR at ARUNACHALAM TRADERS organisation, towards the fulfilment of the award of 'Bachelor of Commerce' during the year 2022-23.

During the period of his internship he has exhibited punctuality and diligence. We wish him every success in life.

For ARUNACHALAM TRADERS  
V.S. Kumar  
Proprietor

(Authorised signature with seal)

Date: 12-01-2023

Place: BANGALORE

  
PRINCIPAL  
The National College  
Jayanagar, Bangalore-70.



GSTIN : 29AEXPJ4577Q2Z3

Mob : +91 9036724426

# JAISHREE ENTERPRISES

# 07, Ground Floor, 1st Main, 2nd Cross, Sir M. Vishweswaraiah Layout, Opp. Raghavendra Mutt  
Devarachikkanahalli Main Road, Bengaluru -560 076. E-mail : jaya\_simha24@hotmail.com

Date:23-05-2023

## PROJECT COMPLETION LETTER

### TO WHOMSOEVER IT MAY CONCERN

This is to certify that Mr. DHANU KUMAR bearing Reg.No. 20NCJC860 of VI Semester B.Com student, The National College, Autonomous, Jayanagar, Bangalore has successfully completed the project work for the period of 06 weeks 11-04-2023 to 22-05-2023 under the guidance of M.Satish Kumar (Manager) at our organisation towards the fulfilment of the award of "Bachelor of Commerce" during the year 2021-22.

The title of his project work was "A study on financial planning for salaried employees."

During the period of his project with us he has exhibited punctuality and diligence.  
We wish her every success in life.

Thanking you.

Form,  
Jaishree garments



Authorised signatory

**JAISHREE ENTERPRISES**  
No. 07, Ground Floor, 1st Main, 2nd Cross,  
Sir M Vishveshwaraiah Layout,  
Devarachikkanahalli Main Road,  
Opp. Raghavendra Mutt, Bangalore-560076.

  
PRINCIPAL  
The National College  
Jayanagar, Bangalore-70.





## CERTIFICATE BY THE GUIDE

This is to certify that **MR.DARSHAN N** bearing Reg. No. **20NCJC859** of the National college, Autonomous, Jayanagar has successfully completed the project work title "**A STUDY ON CONSUMER SATISFACTION.**" in partial fulfillment of requirement for the completion of Bachelor of Commerce program as prescribed by the our institution.

This project report is the record of authentic work carried out by him during the VI Semester of the B.Com Program.

He has work under my guidance. This report has not been submitted to any other university or institution for the award of any degree/diploma/certificate.

**Prof. Arun Kumar G S**  
**Department of Commerce**

Place:

Date:

  
**PRINCIPAL**  
**The National College**  
**Jayanagar, Bangalore-70.**



## CERTIFICATE BY THE GUIDE

This is to certify that **MR.DARSHAN N** bearing Reg. No. **20NCJC859** of the National college, Autonomous, Jayanagar has successfully completed the project work title "**A STUDY ON CONSUMER SATISFACTION.**" in partial fulfillment of requirement for the completion of Bachelor of Commerce program as prescribed by the our institution.

This project report is the record of authentic work carried out by him during the VI Semester of the B.Com Program.

He has work under my guidance. This report has not been submitted to any other university or institution for the award of any degree/diploma/certificate.

**Prof. Arun Kumar G S**  
**Department of Commerce**

Place:

Date:

  
**PRINCIPAL**  
**The National College**  
**Jayanagar, Bangalore-70.**





**SRV RETAIL**

Office : # 19, Platform Road  
Seshadripuram  
Bengaluru - 560 020  
Tel : 080-23566055

**INTERNSHIP COMPLETION CERTIFICATE**

This is to certify that Mr.DARSHAN M, Reg No.20NCJC858, B.Com Final Year student of The National College, Autonomous, Jayanagar, Bangalore has successfully completed internship of 12 days under the guidance of Mr Ashok Savanth (Store Manager)at this organization (*Tanishq Bannerghatta Road*), towards the fulfillment of the award of '*Bachelor of Commerce*' during the year 2022-23.

During the period of his/her internship he/she has exhibited punctuality and diligence. We wish his/her every success in life.

(Authorized signature with seal)

Date:

Place:

  
PRINCIPAL  
The National College  
Jayanagar, Bangalore-70





This is to certify that **Mr. DARSHAN. M** bearing Register No.20NCJC858, VI semester B. Com, **The National College, Autonomous, Jayanagar, Bangalore** has successfully completed a Project of four weeks (from 10/04/2022 to 06/05/2022) under the guidance of (**Mr. AMITH, STORE MANAGER**) at this outlet, towards the fulfilment of award of "Bachelor of Commerce" during the year 2022 – 2023.

The title of his project work was **CUSTOMER PREFERENCE TOWARDS BRANDED & NON BRANDED JEWELLERY.**

During the period of his Project he has exhibited punctuality and diligence. We wish him every success in life.

Date :10/05/2023  
Place: Bangalore

Authorized Signature

  
PRINCIPAL  
The National College  
Jayanagar, Bangalore-70.



#1493, ground floor, near 9<sup>th</sup> block bus stop, 22<sup>nd</sup> main road, 40<sup>th</sup> cross Rd, 4<sup>th</sup> T block east, Jayanagar , Bengaluru, Karnataka 560041, Phone no: 7996998896,  
Email- [vardhmanjewellery@gmail.com](mailto:vardhmanjewellery@gmail.com) , website: [vardhmanjewellers.com](http://vardhmanjewellers.com)





**Karnataka Turned Components Pvt. Ltd.**

Precision Engineering Components

## INTERNSHIP COMPLETION CERTIFICATE

This is to certify that Mr. Chetan, G A Reg. No. 20NCJC857, B.Com final year student of The National College, Autonomous, Jayanagar, Bangalore has successfully completed internship of six weeks under the guidance of Mr. Masilamani, N at this organization, towards the fulfillment of the award of "Bachelor of Commerce" during the year 2022-23.

During the period of His internship has exhibited punctuality and diligence. We wish his every success in life.

Sincerely,

Karnataka Turned Components Pvt Ltd.,

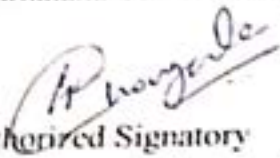

Authorized Signatory  
Asst. Manager- Human Resources



Date: 15/11/2022

Place: Bangalore

  
PRINCIPAL  
The National College  
Jayanagar, Bangalore-70.





# B N Speciality Hospital

Care With Compassion..... Adding Value to Life

#2, "YASHASH COMPLEX", Kalkondrahalli,  
Kasavanahalli Road, Off Sarjapur Main Road,  
Carmelaram Post, Bengaluru - 560 035.

Ph: 080 5000 6689  
+91 9620195989

Email: [bnspecialityhospital@gmail.com](mailto:bnspecialityhospital@gmail.com)

## PROJECT COMPLETION LETTER

### TO WHOMSOEVER IT MAY CONCERN

This is to certify that **Mr. CHETHAN G.A** bearing **Reg.No.20NCJC857** Of VI Semester B.Com student, The National College, Autonomous, Jayanagar, Bangalore has successfully completed the project work for the period of 04 weeks (01-04-2023 To 29-04-2023) under the guidance of A.Rajkumar Designation of External guide Managing Director at our organization towards. The fulfillment of award of "Bachelor of Commerce" during the year 2022-23.

The title of his project work was **THE PROJECT ON JOB SATISFACTION OF EMPLOYEES ON B N SPACIALITY HOSPITAL**

During the period of his project with us he has exhibited punctuality and diligence. We wish him every success in life.

Thanking you.

For, BN SPECIALTY HOSPITAL

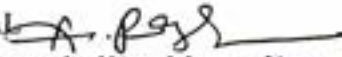
  
**B.N. Speciality Hospital**  
Kasavanahalli Road, Off Sarjapura  
Main Road, Bengaluru-560 035  
Ph.: 8050006689/7411001250

Authorized signatory with company seal

  
PRINCIPAL

The National College

Jayanagar, Bangalore-70



**SPECIALITIES :** General Surgery • Internal Medicine & Diabetology • Cardiology Non-Interventional • Pediatrics  
Obstetrics and Gynecology • Orthopaedics • ENT • Dermatology • Urology • In Patient • Day Care

**FACILITIES :** Specialist Consultation • Lab Facilities • Preventive Health Checkups • Physiotherapy  
Home Care and Doorstep Sample Collection • X-Ray • ECG • Pharmacy 24/7

**Please bring your OLD MEDICAL REPORTS & X-RAY with you.**  
**FOR APPOINTMENT CALL : 080-5000 6689, +91 9620195989**





## PROJECT COMPLETION LETTER

### TO WHOMSOEVER IT MAY CONCERN

This is to certify that Mr./Ms. Ashish V bearing Reg. No. 20NCJC855 of VI Semester B.Com student, The National College, Autonomous, Jayanagar, Bangalore has successfully completed the project work for the period of 06 weeks (01/04/2023 to 12/05/2023) under the guidance of (Sharu & Store Manager) at our organisation towards the fulfilment of award of "Bachelor of Commerce" during the year 2022-23.

The title of his/her project work was : **Consumer perceptions of packing on sales of groceries products at Blinkit.**

During the period of his project with us he has exhibited punctuality and diligence. We wish him every success in life.

Thanking you.

For, (BLINKIT)



Authorised signatory with company seal

*[Handwritten Signature]*  
PRINCIPAL  
The National College  
Jayanagar, Bangalore-70.





## PROJECT COMPLETION LETTER

### TO WHOMSOEVER IT MAY CONCERN

This is to certify that Mr./Ms. Ashish V bearing Reg. No. 20NCJC855 of VI Semester B.Com student, The National College, Autonomous, Jayanagar, Bangalore has successfully completed the project work for the period of 06 weeks (01/04/2023 to 12/05/2023) under the guidance of (Sharu & Store Manager) at our organisation towards the fulfilment of award of "Bachelor of Commerce" during the year 2022-23.

The title of his/her project work was : Consumer perceptions of packing on sales of groceries products at Blinkit.

During the period of his project with us he has exhibited punctuality and diligence. We wish him every success in life.

Thanking you.

For, (BLINKIT)



Authorised signatory with company seal

*[Handwritten Signature]*  
PRINCIPAL  
The National College  
Jayanagar, Bangalore-70.





## INTERNSHIP COMPLETION CERTIFICATE

This is to certify that Mr. ABHISHEK B, Reg No. 20NCJC854, B.Com Final Year student of The National College, Autonomous, Jayanagar, Bangalore has successfully completed Internship of 10 days under the guidance of Mr Ashok Savanth (Store Manager) at this organization (*Tanishq Bannerghatta Road*), towards the fulfillment of the award of 'Bachelor of Commerce' during the year 2022-23.

During the period of his/her Internship he/she has exhibited punctuality and diligence. We wish his/her every success in life.

(Authorized signature with seal)

Date:

Place:

  
PRINCIPAL  
The National College  
Jayanagar, Bangalore-70.

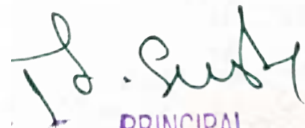



# Briskon

TRANSFORM WITH AGILITY

NO.38/5, Berle Street,  
Langford Town, Hosur Road,  
Bengaluru - 560078

Ref:

Date: 11/06/2023

**PROJECT COMPLETION LETTER**  
**TO WHOMSOEVER IT MAY CONCERN**

This is to certify that Mr. Abhishek.B bearing Reg. No. 20NCJC854 of VI Semester B.Com student, The National College, Autonomous, Jayanagar, Bangalore has successfully completed the project work for the period of 04 weeks 10/05/2023 to 10/06/2023 under the guidance of Mr. Naval Shetty (HR Manager) at our organization towards the fulfillment of award of "Bachelor of Commerce" during the year 2021-22.

The title of his project work was: **A Study on Effectiveness of performance appraisal of an employee in Briskon Technologies Pvt Ltd.**

During the period of his project with us he has exhibited punctuality and diligence. We wish him every success in life.

Thanking you.

**Briskon Technologies Pvt Ltd.**

For Briskon Technologies Pvt. Ltd.

  
Authorised Signatory

Authorised signatory

  
PRINCIPAL  
The National College  
Jayanagar, Bangalore-70.







ಮೊಬೈಲ್ : 95358 39393

## ಪದ್ಮಶಾಲಾ ವಿದ್ಯಾಸಂಸ್ಥೆ (ಲ)

ಪದ್ಮಶ್ರೀ ನರ್ಸರಿ ಮತ್ತು ಹಿರಿಯ ಪ್ರಾಥಮಿಕ ಶಾಲೆ  
(ಕರ್ನಾಟಕ ಸರ್ಕಾರದ ಮಾನ್ಯತೆ ಪಡೆದಿದೆ)

3ನೇ ಕ್ರಾಸ್, ಅಶ್ವತ್ಥಕಟ್ಟೆ ಮುಖ್ಯರಸ್ತೆ, ಕಸ್ತೂರಿಬಾನಗರ, ಬೆಂಗಳೂರು - 560 026.

ಸಂಖ್ಯೆ :

ದಿನಾಂಕ : 28/09/2022

To  
Dr. N K Satya Pal Sharma  
HOD- Department of Commerce  
The National College Autonomous  
Jayanagar, Bangalore- 70

Dear Sir,

Subject: Internship Acceptance Letter –ABHISHEK.M Reg no (20NCJC853)

This is to certify that ABHISHEK.M has joined in our institution on 28/09/2022 and he will be working as internship trainee (Accounts department) in our Institution for the period of 45 days.

Thanking You

Shashi Kalavathy .M

ಶಾಶಿ ಕಲಾವತ್ಯೆ  
Padmasree Higher Primary School  
3rd Cross, Ashwathkattē Nagar  
Kastūrī Nagar, Bengaluru 560026

Padmasree Higher Primary School  
3rd Cross, Ashwathkattē Nagar  
Kastūrī Nagar, Bengaluru 560026

  
PRINCIPAL  
The National College  
Jayanagar, Bangalore-70.





ಬೆಂಗಳೂರು ಮಹಾನಗರ ಸಾರಿಗೆ ಸಂಸ್ಥೆ :: ಕೇಂದ್ರ ಕಛೇರಿ

ದಿನಾಂಕ: 18 / 08 / 2023

ಸಂಖ್ಯೆ/ಕೇರ/ / 2023-24

ಮೀಸಲಾತಿ ಮತ್ತು ಕಲ್ಯಾಣಾಧಿಕಾರಿಗಳು (ಮಾಸಂಅ),  
ಸಂಪನ್ಮೂಲ ಅಭಿವೃದ್ಧಿ ಇಲಾಖೆ,  
ಬೆಂಗಳೂರು ಮಹಾನಗರ ಸಾರಿಗೆ ಸಂಸ್ಥೆ,  
ಕೇ. ಶಾಂತಿನಗರ,  
ಬೆ - 560 027.

ವಾಸ್ಯರೇ,

ವಿಷಯ:- ಬೆಂ.ಮ.ಸಾ.ಸಂಸ್ಥೆಯಲ್ಲಿ ಶೈಕ್ಷಣಿಕ ಉದ್ದೇಶಕ್ಕಾಗಿ ವಿದ್ಯಾರ್ಥಿಗಳು ಪ್ರಾಜೆಕ್ಟ್ ವರ್ಕ್ ಮಾಡಿ ವರದಿ ಸಲ್ಲಿಸಿರುವ ಕುರಿತು.

.....

ಇದರ ವಿಷಯಕ್ಕೆ ಸಂಬಂಧಿಸಿದಂತೆ, **ಬ್ರಿಟಿಷ್ ವಿಂ** ರವರು ಶೈಕ್ಷಣಿಕ  
ಗಾಗಿ ಬೆಂ.ಮ.ಸಾ.ಸಂಸ್ಥೆಯ **ವಿಜ್ಞಾನ** ಇಲಾಖೆಯಲ್ಲಿ "ORGANISATION STUDY ON  
..... ವಿಷಯದಲ್ಲಿ ಪ್ರಾಜೆಕ್ಟ್ ವರ್ಕ್ ಮಾಡಿದ್ದು, ಈ ಬಗ್ಗೆ ವರದಿಯನ್ನು  
..... ಸದರಿ ವರದಿಯನ್ನು ಪರಿಶೀಲಿಸಿದ್ದು, ಸಂಸ್ಥೆಗೆ ಸಂಬಂಧಪಟ್ಟ ಮಾಹಿತಿಯು ಸರಿಯಾಗಿರುತ್ತದೆ  
..... ಪ್ರಾಜೆಕ್ಟ್ ವರ್ಕ್‌ನಲ್ಲಿ ಸಂಸ್ಥೆಯ ಕುರಿತು ಯಾವುದೇ ಪ್ರತಿಕೂಲವಾದ ಅಂಶಗಳು ಇರುವುದಿಲ್ಲ. ಸದರಿ  
..... ಪ್ರಾಜೆಕ್ಟ್ ವರ್ಕ್ ಮಾಡಿರುವ ಕುರಿತು ಪ್ರಮಾಣ ಪತ್ರ ನೀಡಬಹುದಾಗಿದ್ದು, ಪ್ರಾಜೆಕ್ಟ್ ವರ್ಕ್‌ನ  
..... ಸದರಿ ಪತ್ರದೊಂದಿಗೆ ಅಡಕಗೊಳಿಸಿ ತಮ್ಮ ಮುಂದಿನ ಕ್ರಮಕ್ಕಾಗಿ ಕಳುಹಿಸಲಾಗಿದೆ.

ತಮ್ಮ ವಿಶ್ವಾಸಿ,

*[Handwritten signature]*  
18/08/23

*[Handwritten signature]*  
PRINCIPAL  
The National College  
Jayanagar, Bangalore-70.





# NITRO INDUSTRIES

Sheet Metal Fabrication: SS and MS.

DATE : 21/09/2022

TO  
DR. N K SATYA PAL SHARMA  
HOD- DEPARTMENT OF COMMERCE  
THE NATIONAL COLLEGE  
AUTONOMOUS  
JAYANAGAR, BANGALORE-70

DEAR SIR,

SUBJECT: INTERNSHIP ACCEPTANCE LETTER – YASHWANTH Y (20NCJC852)

THIS IS TO CERTIFY THAT MR. YASHWANTH Y REG. NO.20NCJC852 HAS JOINED IN OUR INDUSTRY ON 21/09/22 AND HE WILL BE WORKING AS INTERNSHIP TRAINEE IN OUR INDUSTRY FOR THE PERIOD OF 45 DAYS.

THANKING YOU



*D. Sush*  
PRINCIPAL  
The National College  
Jayanagar, Bangalore-70.





**FASHION  
FACTORY**  
BRANDS FOR LESS

## INTERNSHIP COMPLETION CERTIFICATE

This is to certify that J. VISHWAS Reg No. 20NCJC851. B. Com Final Year student of The National College, Autonomous, Jayanagar, Bangalore has successfully completed internship of six weeks under the guidance of – Ajith Kumar. at this organization, towards the fulfilment of the award of 'Bachelor of Commerce' during the year 2022-23.

During the period of his internship, he has exhibited punctuality and diligence. We wish his every success in life.

Yours Sincerely

For Reliance trends junior

K AJITH KUMAR

HR MANAGER

*Ajith Kumar*  
RELiance RETAIL LTD  
Survey No. 152/5, Doddathohur Village,  
Begur Hobli, Neeladri Rd, Bengaluru - 560100  
PRINCIPAL  
The National College,  
Jayanagar, Bangalore-70.







## PROJECT COMPLETION LETTER

### TO WHOMSOEVER IT MAY CONCERN

This is to certify that Mr.VISHWAS.J bearing Reg. No.20NCJC851 of VI Semester B.Com student, The National College, Autonomous, Jayanagar, Bangalore has successfully completed the project work for the period of 06 weeks (18/5/2023 TO 10/6/2023) under the guidance of (SULOCHANA.B AND HARSAN VARDAN) at our organisation towards the fulfilment of award of "Bachelor of Commerce" during the year 2021-22.

The title of his project work was Web designing on good wrapper.

During the period of his project with us he has exhibited punctuality and diligence. We wish him every success in life.

Thanking you.

For, YUNO PACKAGING PRIVATE LIMITED

Authorised signatory with company seal



*Sushy*

PRINCIPAL  
The National College  
Jayanagar, Bangalore-70





## INTERNSHIP COMPLETION CERTIFICATE.

This is to certify that Mr. Vishal M Reg No. 20NCJC850 B.Com Final Year student of The National College, Autonomous, Jayanagar, Bangalore has successfully completed internship of six weeks under the guidance of Praveen Kumar (Technical architect) at this organization, towards the fulfillment of the award of 'Bachelor of Commerce' during the year 2022-23.

During the period of his internship he has exhibited punctuality and diligence. We wish his every success in life.

*Handwritten signature*



Date:  
Place:

Corporate Office: 11 B2, Lakshmi Krupa, Pachana Layout, 1st Street, Choolamedu, Chennai-600044, Tamil Nadu

Web: [eyefocusip.com](http://eyefocusip.com) Email: [info@eyefocusip.com](mailto:info@eyefocusip.com)

*Handwritten signature*  
PRINCIPAL  
The National College  
Jayanagar, Bangalore-70.







HMT (International) Limited  
A Government of India Enterprise



## PROJECT COMPLETION LETTER

### TO WHOMSOEVER IT MAY CONCERN

This is to certify that Mrs. Vathsala bearing Reg No. 20NCJC849 of VI Semester B.Com student, The National College, Autonomous, Jayanagar, Bangalore has successfully completed the project work for the period of 06 weeks from 14.04.2023 to 01.06.2023 Under Ramesh, Departmental Head at our organisation towards the fulfilment of award of "Bachelor of Commerce" during the year 2022-2023.

The title of her project work was Effectiveness of team work and team building.

Her roles and responsibilities included that of Audit Associate. During the Project program with us she was found to be hardworking and efficient. We wish her lots of success in all her upcoming endeavours.

Thanking You.

Planotech

Authorised signatory with company seal



*[Signature]*  
PRINCIPAL  
The National College  
Jayanagar, Bangalore-70.



## INTERNSHIP COMPLETION CERTIFICATE

This is to certify that Ms.VATHSALA BN, Reg No.20NCJC849, B.Com Final Year student of The National College, Autonomous, Jayanagar, Bangalore has successfully completed internship of 13 days under the guidance of Mr Ashok Savanth (Store Manager) at this organization (*Tanishq Bannerghatta Road*), towards the fulfillment of the award of 'Bachelor of Commerce' during the year 2022-23.

During the period of his/her internship he/she has exhibited punctuality and diligence. We wish his/her every success in life.





(Authorized signature with seal)

Date:

Place:



PRINCIPAL  
The National College  
Jayanagar, Bangalore-70.







## INTERNSHIP COMPLETION CERTIFICATE

This is to certify that UMA PAVANI.M Reg No.20NCJC848 B. Com Final Year student of The National College, Autonomous, Jayanagar, Bangalore has successfully completed internship of six weeks under the guidance of – SOUNDARYA P at this organization, towards the fulfilment of the award of 'Bachelor of Commerce' during the year 2022-23.

During the period of her internship, she has exhibited punctuality and diligence. We wish her every success in life.

  
DOMINGO'S PIZZA  
# 223, Ground Floor, 100th Road,  
Vajarahalli, Bengaluru-560 109.  
Ph - 9038955790

Date:

Place:

  
PRINCIPAL  
The National College  
Jayanagar, Bangalore-70.





**B. MALLAIAH & CO.,**  
CHARTERED ACCOUNTANTS

TO WHOMSOEVER IT MAY CONCERN

CERTIFICATE

This is to certify that Ms UMA PAVANI. M, Student of THE NATIONAL COLLEGE, AUTONOMOUS, Jayanagar bearing the register number 20NCJC848 has successfully completed 4 weeks (12.04.2023 to 11.05.2023) internship program at our Office. In internship program she handled Accounting, Tax Calculations and assisted by seniors in auditing process.

During the period of her internship program with us, she was found sincere, punctual and hardworking.

We wish her every success in life.

Place: Bangalore  
Date : 16.06.2023

For B. Mallaiah & Co.,  
Chartered Accountants,  
FRN.083045  
  
16/06/2023  
  
B. Mallaiah)  
Partner  
M.No. 207769

  
PRINCIPAL  
The National College  
Jayanagar, Bangalore-70.





## INTERNSHIP COMPLETION CERTIFICATE

This is to certify that Mr. UDAY SHANKAR KS, Reg No.20NCJC847, B.Com Final Year student of The National College, Autonomous, Jayanagar, Bangalore has successfully completed internship of 20 days under the guidance of Mr Ashok Savanth (Store Manager) at this organization (*Tanishq Bannerghatta Road*), towards the fulfillment of the award of '*Bachelor of Commerce*' during the year 2022-23.

During the period of his/her internship he/she has exhibited punctuality and diligence. We wish his/her every success in life.

  
  
(Authorized signature with seal)

Date:

Place:

  
PRINCIPAL  
The National College  
Jayanagar, Bangalore-70.





## PROJECT COMPLETION LETTER

### TO WHOMSOEVER IT MAY CONCERN

This is to certify that **Mr. KS Udaya Shankar** bearing Reg No. **20NCJC847** of VI Semester B.Com student, The National College, Autonomous, Jayanagar, Bangalore has successfully completed the project work for the period of 06 weeks from 14.04.2023 to 01.06.2023 Under **Sudhakar**, Departmental Manager at our organisation towards the fulfilment of award of "Bachelor of Commerce" during the year 2022-2023.

The title of his project work was Corporate and Incorporate Event Manager

During the period of his project with us he has exhibited punctuality and diligence. We wish him every success in life.

Thanking You.

Planotech



Authorised signatory with company seal

  
PRINCIPAL  
The National College  
Jayanagar, Bangalore-70.







ಕರ್ನಾಟಕ ಸಹಕಾರಿ ಹಾಲು ಉತ್ಪಾದಕರ ಮಹಾಸಂಘದ ನಿಯಮಿತ  
KARNATAKA CO-OPERATIVE MILK PRODUCER'S FEDERATION LIMITED



No.KMF/2040/Adm-1/2023

Date: 23.01.2023

**CERTIFICATE**

This is to certify that **Mr.Sumanth N (Reg.No.20NCJC845)** studying B.Com at The National College Autonomous, Jayanagar, Bengaluru, has successfully completed Internship on "Organization Study at Karnataka Milk Federation Ltd"during period from 29.09.2022 to 09.11.2022. This certificate is issued for the purpose of academics only. His conduct during this period is found to be good.

Your's faithfully,

for Karnataka Co-Operative Milk Federation Ltd.,

*Sumanth N. M*  
Joint Director (Admin)

ಜಂಟಿ ನಿರ್ದೇಶಕರು (ಆಡಳಿತ)  
ಕರ್ನಾಟಕ ಸಹಕಾರಿ ಹಾಲು ಉತ್ಪಾದಕರ ಮಹಾಸಂಘದ ನಿಯಮಿತ  
ಬೆಂಗಳೂರು - 560 029

*[Signature]*  
PRINCIPAL  
The National College  
Jayanagar, Bangalore-70.



20NCJC845

**BLUE DART**

EXPRESS LIMITED  
Manipal road dwaraka nagar near,  
century indus apartment RR nagar,  
Bangalore - 560098.

[www.bluedart.com](http://www.bluedart.com)

Communications@bluedart.com

**TO WHOMSOEVER IT MAY CONCERN**

This is to certify that Mr. **SUMANTH N** bearing Reg. No.20NCJC845 of VI Semester B.com student, The National College, Autonomous, Jayanagar, Bangalore has successfully completed the project work for the period of 06 weeks **28<sup>th</sup> March 2023 to 12<sup>th</sup> May 2023** under the guidance of **Shilpa N, Manager** at our organisation towards the fulfilment of award of "Bachelor of Commerce" during the year 2022-23.

The title of his project work was "**A Project Study on Risk management with Special Reference to Blue Dart**".

During the period of his project with us he has exhibited punctuality and diligence. We wish him every success in life.

Thanking you,

For (BLUE DART EXPRESS LIMITED)



*Shilpa N*  
PRINCIPAL  
The National College  
Jayanagar, Bangalore-70.





# SRSV AGRO COMPANY

# 8/69, 'Prabhat Complex'  
Kempegowda Road  
Bengaluru - 560 009

## INTERNSHIP COMPLETION CERTIFICATE

This is to certify that Mr. Shreyas, Register No. 20NCJC843, B.com Final Year student of The National College, Autonomous, Jayanagar, Bangalore has Successfully Completed Internship of 18 days Under the Guidance of Mr. Kishan At Mia Tanishq Jayanagar, Towards the fulfillment of the award of 'Bachelor of Commerce' during the year of 2022 - 23.

During the period of his internship he exhibited punctuality and diligence. We wish his every success in life.

Date : 02/11/2022

Place: Bangalore



Hr-Executive

Tanishq Jayanagar

For SRSV AGRO COMPANY



PRINCIPAL

The National College  
Jayanagar, Bangalore-70.



Show Room : No. 83/2, 9th Main Road, 4th Block, Jayanagar, BENGALURU - 560 011  
Mob : 7338273383

20NCJC843

#289/2, 4th Floor,  
Kothari Business Chambers,  
Kasturba Nagar,  
Mysore Road, Bangalore-560 026



## PROJECT COMPLETION LETTER

DATE: 30 MAY 23

### TO WHOMSOEVER IT MAY CONCERN

This is to certify that Mr. SHREYAS N M bearing Reg. No. 20NCJC843 of VI Semester B. Com student, The National College, Autonomous, Jayanagar, Bangalore has successfully completed the project work for the period of 06 weeks on 17 APRIL 2023 to 30 MAY 2023 under the guidance of MR. SHARAN AS MANAGER at our organisation towards the fulfilment of award of "Bachelor of Commerce" during the year 2022-23.

The title of his project work was "A STUDY ON IMPACT OF PERFORMANCE APPRAISAL ON STAFF PRODUCTIVITY".

During the period of his project with us he has exhibited punctuality and diligence. We wish him every success in life.

Thanking you.

For, RAJSONS PHARMA PVT LIMITED



*[Signature]*  
PRINCIPAL  
The National College  
Jayanagar, Bangalore-70.



*[Signature]*  
30/5/23  
Authorised signatory



## SRI MANUNATHA TRACTORS & FARM EQUIPMENTS

Authorized Dealer: **BEICHER TRACTORS** (Sales, Service and Spares)  
No. No. 56/2, Halpalehalli, Navalur Hobli, All India Main Road, Ankal, Bangalore 562106  
Mobile: 9482742008, 9483240004 e-mail: sribeicertactors2@gmail.com



### INTERNSHIP COMPLETION CERTIFICATE

This is to certify that Shashank, Reg No. 20NCJC842, B.Com Final Year student of The National College, Autonomous, Jayanagar, Bangalore has successfully completed internship of six weeks under the guidance of – Harshith.S at this organization, towards the fulfillment of the award of 'Bachelor of Commerce' during the year 2022-23.

During the period of his internship he has exhibited punctuality and diligence. We wish his every success in life.

Thankyou  
Your regards



Harshith.S.  
Sales Manager

PRINCIPAL  
The National College  
Jayanagar, Bangalore-70.





**Aghanta Retail Pvt. Ltd.**

Corporate Office: 237 1<sup>st</sup> Floor, Patil Business Center, RMV Extension, Dr. C.V Raman Road,  
Sadashivanagar Bengaluru - 56  
www.alpinesivaapl.com

## PROJECT COMPLETION LETTER

### TO WHOMSOEVER IT MAY CONCERN

This is to certify that Mr. Shashank bearing Reg. No. 20NCJC842 of VI Semester B.Com., student, The National College, Autonomous, Jayanagar, Bangalore has successfully completed the project work for the period of 06 weeks 10th April 2023 to 20<sup>th</sup> May 2023 under the guidance of Mr. Nagaraj G Finance Manager at our organization towards the fulfillment of award of "Bachelor of Commerce" during the year 2022-23.

The title of his project work was :- Profit management system .

During the period of his project with us he has exhibited punctuality and diligence. We wish him every success in life.

Thanking you.

For and on behalf of Aghanta Retail Pvt. Limited.

  
Mr. Nagaraj. G

Finance Manager.

Aghanta Retail Pvt. Ltd.  
Alpine Viva Owners Welfare  
Association (AVOWA)  
S.No. 139, Whitefield, Hoskote Road  
Sai Gardens, Seegehalli  
Krishnarajapura, Bangalore-560 067

  
PRINCIPAL

The National College  
Jayanagar, Bangalore-70.





# SRV RETAIL

Office : # 19, Platform Road  
Seshadripuram  
Bengaluru - 560 020  
Tel : 080-23566055

## INTERNSHIP COMPLETION CERTIFICATE

This is to certify that Mr. SANJAN MA, Reg No.20NCJC841, B.Com Final Year student of The National College, Autonomous, Jayanagar, Bangalore has successfully completed internship of 24 days under the guidance of Mr Ashok Savanth (Store Manager) at this organization (*Tanishq Bannerghatta Road*), towards the fulfillment of the award of '*Bachelor of Commerce*' during the year 2022-23.

During the period of his/her internship he/she has exhibited punctuality and diligence. We wish his/her every success in life.

  
(Authorized signature with seal)



Date:

Place:

  
PRINCIPAL  
The National College  
Jayanagar, Bangalore-70.



**TO WHOMSOEVER IT MAY CONCERN**

This is to certify that Mr./Ms. SANJAN.H.D bearing Reg. No. 20NC5C841 of VI Semester B.Com student, The National College, Autonomous, Jayanagar, Bangalore has successfully completed the project work for the period of 06 weeks (Mention the dates) under the guidance of (Name & Designation of External guide) at our organisation towards the fulfilment of award of "Bachelor of Commerce" during the year 2021-22.

The title of his/her project work was AMAZON STORE DIGITAL AUDIT

During the period of his/her project with us he/she has exhibited punctuality and diligence. We wish him/her every success in life.

Thanking you.

For, (Company Name)

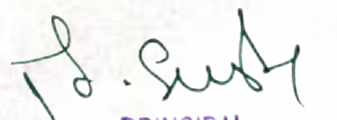

Authorised signatory with company seal

  
PRINCIPAL  
The National College  
Jayanagar, Bangalore-70.







# Swemed Biomedicals Pvt. Ltd.

29/1 first floor, Chunchanaghatta Cross, Yelachenahalli, Bengaluru 560062

## ACCEPTANCE LETTER

DATE: 9/10/2022

To  
Dr. N K Satya Pal Sharma  
HOD- Department of Commerce  
The National College  
Autonomous  
Jayanagar, Bangalore- 70

Dear sir,

Subject: Internship Acceptance Letter - SANTHOSH.S. Reg No: 20NCJC840

This is to certify that **Mr. SANTHOSH.S.**, Reg. No. **20NCJC840** has joined in our organization on **9/10/2022** and he will be working as internship trainee in our **SWEMED Biomedicals Pvt. Ltd.** for the period of 45 days.

Thanking You

With Regards

For SWEMED Biomedicals Pvt. Ltd.

For SWEMED BIOMEDICALS PVT. LTD

*Kumars*  
Authorized signatory

HR Manager

*D. Sush*  
PRINCIPAL  
The National College  
Jayanagar, Bangalore-70.





# Mahalakshmi Chemical Pvt. Ltd.

## TO WHOMSOEVER IT MAY CONCERN

This is to certify that Mr. Santosh. S, bearing Reg.No. 20NCJC840 of VI Semester B.Com student, The National College, Autonomous, Jayanagar, Bangalore has successfully completed the project work for the period of 6 weeks, From 17/04/2023 to 20/05/2023 under the guidance of (RAGHU KUMAR) at our organisation towards the fulfilment of award of "Bachelor of Commerce" during the year 2022-23.

The title of his project work was improving productivity through effective time management system

During the period of his project with us he has exhibited punctuality and diligence. We wish his every success in life.

Thank you,

For,  
Mahalakshmi Chemical Pvt. Ltd.

  
**Mahalakshmi Chemicals**  
No.8, Krishnanagar, Kothanur  
Main Road, Bangalore - 76

  
PRINCIPAL  
The National College  
Jayanagar, Bangalore-70.





**KMF**

ಕರ್ನಾಟಕ ಸಹಕಾರಿ ಹಾಲು ಉತ್ಪಾದಕರ ಮಹಾಮಂಡಳ ನಿಯಮಿತ  
KARNATAKA CO-OPERATIVE MILK PRODUCER'S FEDERATION LIMITED



No.KMF/2040/Adm-1/2023

Date: 23.01.2023

**CERTIFICATE**

This is to certify that Mr.Sai Manoj (Reg.No.20NCJC839) studying B.Com at The National College Autonomous, Jayanagar, Bengaluru, has successfully completed Internship on "Organization Study at Karnataka Milk Federation Ltd" during period from 29.09.2022 to 09.11.2022. This certificate is issued for the purpose of academics only. His conduct during this period is found to be good.

Your's faithfully,

for Karnataka Co-Operative Milk Federation Ltd.,

*Surekha N.M*  
Joint Director (Admin)

ಜಂಟಿ ನಿರ್ದೇಶಕರು (ಆಡಳಿತ)  
ಕರ್ನಾಟಕ ಹಾಲು ಮಹಾಮಂಡಳ ನಿಯಮಿತ  
ಬೆಂಗಳೂರು-560 029.

*S. Suresh*  
PRINCIPAL  
The National College  
Jayanagar, Bangalore-70.



ಕೆ.ಎಂ.ಎಫ್ ಸಂಕೀರ್ಣ, ಅಂಚೆ ಬಿಲ್ಡಿಂಗ್ ಸಂಖ್ಯೆ : 2915, ಡಾ|| ಎಂ.ಹೆಚ್. ಮರಿಗೌಡ ರಸ್ತೆ, ಬೆಂಗಳೂರು - 560-029.

Complex, P.B. No. 2915, Dr. M.H. Marigowda Road, Bengaluru - 560 029. Phone : 080-26096800, 25536625, Fax : 080-25536105.  
mail ps.md@kmf.coop / admin@kmf.coop / finance@kmf.coop / marketing@kmf.coop / purchase@kmf.coop / mis@kmf.coop  
ahykmf@yahoo.com / step@kmf.coop / cti@kmf.coop / qc@kmf.coop / Website : www.kmfandini.coop



**PROJECT COMPLETION LETTER**

**TO WHOMSOEVER IT MAY CONCERN**

This is to certify that Mr.SAI MANOJ bearing Reg. No.20NCJC839 of VI Semester B.Com student. The National College,Autonomous,Jayanagar,Bangalore. Has successfully completed the project work for the period of 04 weeks From 17-04-2023 To 17-05-2023 under the guidance of CA.REDDI KUMAR REDDY N, CHARTERED ACCOUNTANT, PROPRIETOR,@ NRK REDDY AND CO, CHARTERED ACCOUNTANTS towards the fulfillment of award of "Bachelor of Commerce" during the year 2022-23.

The title of his project is **Audit and Tax at NRK REDDY & CO**

During the period of his/her project with us he/she has exhibited punctuality and diligence. We wish him/her every success in life.

Thanking you.

For NRK REDDY AND CO,

For NRK REDDY & CO,  
Chartered Accountants & CO,  
Chartered Accountants

CA Reddi Kumar Reddy N  
Proprietor  
M.No. 215714 FRN: 0113845  
Proprietor

Date: 20/05/2023

  
PRINCIPAL  
The National College  
Jayanagar, Bangalore-70.







ST. JOHN'S NATIONAL ACADEMY OF HEALTH SCIENCES  
ST. JOHN'S MEDICAL COLLEGE HOSPITAL

Sarjapur Road,  
Bengaluru - 560 034, India.  
Tel : + 91 80 2206 5000  
+ 91 80 2553 0724  
Fax : + 91 80 2553 0070  
Email : sjnichadmin.office@stjohns.in  
www.stjohns.in



H-2020-0690

## INTERNSHIP COMPLETION CERTIFICATE

This is to certify that Mr. Robert Singh R Reg No. 20NCJ 838, B.Com Final Year student of The National College, Autonomous, Jayanagar, Bangalore has successfully completed internship of six weeks under the guidance of Mr. Batchu Nagaswaroop, CA, CMA Manager, Finance & Accounts at this organization, towards the fulfillment of the award of 'Bachelor of Commerce' during the year 2022-23.

During the period of his/her internship he/she has exhibited punctuality and diligence. We wish his/her every success in life.

*B. Nagaswaroop 18/11/22*  
(Authorized signature with seal)

MANAGER FINANCE & ACCOUNTS  
St. John's Medical College Hospital  
Sarjapur Road  
Bengaluru - 560 034

Date: 18/11/22  
Place: B'10/70

*D. Subh*  
PRINCIPAL  
The National College  
Jayanagar, Bangalore-70.





**Pragati Corporate Consultancy Pvt. Ltd**  
*We Rise By Lifting Others...*

## **PROJECT COMPLETION LETTER**

### **TO WHOMSOEVER IT MAY CONCERN**

This is to certify that Mr/Ms Robert Singh R bearing Reg. No. 20NCJC838 of VI Semester B.Com student, The National College, Autonomous, Jayanagar, Bangalore has successfully completed the project work for the period of 06 weeks (03-04-2023 To 29-04-2023) under the guidance of (Mr. J Jayaram, Manager in Pragati Corporate Consultancy Pvt Ltd) at our organisation towards the fulfilment of award of "Bachelor of Commerce" during the year 2021-22.

The title of his/her project work was - Talent Acquisition

During the period of his/her project with us he/she has exhibited punctuality and diligence. We wish him/her every success in life.

Thanking you.

For, (Pragati Corporate Consultancy Pvt Ltd)

For PRAGATI CORPORATE CONSULTANCY PVT. LTD.

MANAGING DIRECTOR

Authorised signatory with company seal

Get in touch with us:

[www.pragaticorporateconsultancy.com/](http://www.pragaticorporateconsultancy.com/)

[hr@pragaticorporateconsultancy.com](mailto:hr@pragaticorporateconsultancy.com)

PRAGATI CORPORATE CONSULTANCY PRIVATE LIMITED

Vakil Square, 3<sup>rd</sup> Floor, WJ92+W82 Bannerghatta Main Rd, KEB Colony, New Gurappana Palya, Jaynagara  
9<sup>th</sup> Block, BTM Layout Bengaluru, Karnataka 560029





# SRSV AGRO COMPANY

# 8/65, 'Prabhat Complex'  
Kempeswda Road  
Bengaluru - 560 079

## INTERNSHIP COMPLETION CERTIFICATE

This is to certify that Mr.Punith Gowda AJ, Register No.20NCJC236, B.com Final Year student of The National College, Autonomous, Jayanagar, Bangalore has Successfully Completed Internship of 17 days Under the Guidance of At Tanishq Caratlane Jayanagar, Towards the fulfillment of the award of 'Bachelor of Commerce' during the year of 2022 - 23.

During the period of his internship he exhibited punctuality and diligence. We wish his every success in life.

Date :02/11/2022

Place:Bangalore



Hr-Executive

Tanishq Jayanagar

For SRSV AGRO COMPANY

Partner

  
PRINCIPAL  
The National College  
Jayanagar, Bangalore-70.



Show Room : No. 83/2, 9th Main Road, 4th Block, Jayanagar, BENGALURU - 560 011  
Mob : 7338273383



**RATHNA PACKAGING INDIA PRIVATE LIMITED**  
*Solutions for Flexible Packaging Materials*

**TO WHOM SO EVER IT MAY CONCERN**

To,

The Head of Department - Commerce,  
The National College,  
Jayanagar, Bangalore – 560 070.

Dear Sir,

Sub: Acceptance of Inplant Training at our plant – Reg.

We agree to take Miss. G.Priyanka, Reg. No : 20NCJC835 as a In Plant trainee at our plant. Which is his part of Curriculum according to her communication the Training.

Yours truly,

For Rathna Packaging India Pvt Ltd,

*D. Paranthaman*  
D. Paranthaman

Sr.Manager - HR

PHONE:9894767703.



Place : Hosur,

Date: 21-09-2022.

*D. Sush*

PRINCIPAL

The National College  
Jayanagar, Bangalore-70

Registered Office : No. 19, 15th Main, 15th Cross, Sector 4, HSR Layout, BANGALORE - 560 102, Karnataka, India | Tel : +91 80 25720805  
CIN No.: U21022KA2005PTC038098 | Email : rathnapackagingindia@yahoo.co.in | Web : www.rathnagroup.in  
Unit I : No. 55A, Sipcot Industrial Complex, Phase 1, Mookandapalli Post, HOSUR - 635126, Krishnagiri Dist. Tel: +91 84344 40027 | Mob.: 8220009068  
Unit II : No. 852/2A, Aggondapalli Village, Achettyapalli Post - 635 110, DENKANIKOTTA Taluk, Krishnagiri Dist. | Mob.: 98942 56111  
Unit III : Sy. No. 66-2, Mugalapalli Village, Thommanapalli Panchayath, Bagalur to Berigai Road, Hosur - 635 105, Krishnagiri Dist.  
Unit IV : Plot No. 86, KIADB Industrial Area, 2nd Phase, 2nd Sector Bidadi - 562 109.







**RATHNA PACKAGING INDIA PRIVATE LIMITED**  
*Solutions for Flexible Packaging Materials*

**TO WHOMSOEVER IT MAY CONCERN**

This is to certify that Ms.G.Priyanka bearing Reg.No. 20NCJC835 of VI Semester B.Com student, The National College, Autonomous, Jayanagar, Bangalore has successfully completed the project work for the period of 6 weeks, From 17/04/2023 to 26/05/2023 under the guidance of (SR.MANAGER - HR D. PARANTHAMAN) at our organisation towards the fulfilment of award of "Bachelor of Commerce" during the year 2022-23.

The title of her project work was **Impact of Packaging on Consumer buying Behaviour**

During the period of her project with us she has exhibited punctuality and diligence. We wish her every success in life.

Thank you



For,

*D. Paranthaman*

Rathana Packaging India Pvt Ltd

*D. Sush*  
PRINCIPAL  
The National College  
Jayanagar, Bangalore-70.



Registered Office: No. 19, 15th Main, 15th Cross, Sector 4, HSR Layout, BANGALORE-560 102, Karnataka, India Tel: +91 80 25720905  
Reg. No: U21022KA2005J1TC038090 | Email: rathnapackagingipl@yahoo.co.in | Web: [www.rathnagroup.in](http://www.rathnagroup.in)  
Branch I: No. 55A, Sipcot Industrial Complex, Phase 1, Mookandapalli Post, HOSUR-635126, Krishnagiri Dist. Tel: +91 04344 400221, Mob: 8220009068  
Branch II: No. 852/2A, Aggandapalli Village, Achettyapalli Post-635 110, DENKANIKOTTA Taluk, Krishnagiri Dist. Mob: 96542 56111  
Branch III: Sy. No. 66-2, Megalapalli Village, Thommanapalli Panchayath, Bagalur to Berigai Road, Hosur - 635 105, Krishnagiri Dist.  
Branch IV: Plot No. 86, KIADB Industrial Area, 2nd Phase, 2nd Sector Bidadi-562 109.





**RATHNA PACKAGING INDIA PRIVATE LIMITED**  
*Solutions for Flexible Packaging Materials*

**TO WHOMSOEVER IT MAY CONCERN**

This is to certify that Ms.G.Priyanka bearing Reg.No. 20NCJC835 of VI Semester B.Com student, The National College, Autonomous, Jayanagar, Bangalore has successfully completed the project work for the period of 6 weeks, From 17/04/2023 to 26/05/2023 under the guidance of (SR.MANAGER - HR D. PARANTHAMAN) at our organisation towards the fulfilment of award of "Bachelor of Commerce" during the year 2022-23.

The title of her project work was **Impact of Packaging on Consumer buying Behaviour**

During the period of her project with us she has exhibited punctuality and diligence. We wish her every success in life.

Thank you



For,

*D. Paranthaman*

Rathana Packaging India Pvt Ltd

*D. Sush*  
PRINCIPAL  
The National College  
Jayanagar, Bangalore-70.



Registered Office: No. 19, 15th Main, 15th Cross, Sector 4, HSR Layout, BANGALORE-560 102, Karnataka, India Tel: +91 80 25720905  
Reg. No: U21022KA2005J1TC038090 | Email: rathnapackagingipl@yahoo.co.in | Web: [www.rathnagroup.in](http://www.rathnagroup.in)  
Branch I: No. 55A, Sipcot Industrial Complex, Phase 1, Mookandapalli Post, HOSUR-635126, Krishnagiri Dist. Tel: +91 04344 400221, Mob: 8220009068  
Branch II: No. 852/2A, Aggandapalli Village, Achettyapalli Post-635 110, DENKANIKOTTA Taluk, Krishnagiri Dist. Mob: 96542 56111  
Branch III: Sy. No. 66-2, Megalapalli Village, Thommanapalli Panchayath, Bagalur to Berigai Road, Hosur - 635 105, Krishnagiri Dist.  
Branch IV: Plot No. 86, KIADB Industrial Area, 2nd Phase, 2nd Sector Bidadi-562 109.







LOANZEN FINANCE PVT LTD

CIN: U65999KA2017PTC100666 | www.loanzen.in

Office: No. 445/1 2<sup>nd</sup> Floor, 6<sup>th</sup> Cross Road, Jayanagar 7<sup>th</sup> Block, West of Kanakapura road  
Bangalore - 560070

Contact: +91 91080 47087, hello@loanzen.in

## Acceptance Letter

November 02, 2022

To,  
Dr. N K Satya Pal Sharma  
HOD - Department of Commerce  
The National College  
Autonomous  
Jayanagar, Bangalore - 70

**Subject: Internship acceptance Letter - Pramodh M / 20NCJC833**

Dear Sir,

This is to certify that Mr. Pramodh M, Reg No - 20NCJC833 has joined our organization on November 02, 2022 and will be working as internship trainee on our company for a period of 45 days.

Thanking You,

With Regards,

For Loanzen Finance Private. Ltd.

  
Authorized Signatory  

  
PRINCIPAL  
The National College  
Jayanagar, Bangalore-70





युनाइटेड इंडिया इंश्योरेंस कंपनी लिमिटेड  
UNITED INDIA INSURANCE COMPANY LTD.  
At United India, it's always U before I

## PROJECT COMPLETION LETTER

DATE: 27 MAY 2023

### TO WHOMSOEVER IT MAY CONCERN

This is to certify that Mr. PRAMODH M bearing Reg. No. 20NCJC833 of VI Semester B.Com student, The National College, Autonomous, Jayanagar, Bangalore has successfully completed the project work for the period of 06 weeks on 17 APRIL 2023 TO 27 MAY 2023 under the guidance of MR PRAKASH S UNITED INDIA INSURANCE LIMITED at our organisation towards the fulfilment of award of "Bachelor of Commerce" during the year 2022-23.

The title of his project work was "A STUDY ON MOTOR INSURANCE AND CUSTOMER SATISFACTION TOWARDS MOTOR INSURANCE AT UNITED INDIA INSURANCE".

During the period of his project with us he has exhibited punctuality and diligence. We wish him every success in life.

Thanking you.

For, UNITED INDIA INSURANCE COMPANY LIMITED



Authorised signatory

  
PRINCIPAL  
The National College  
Jayanagar, Bangalore-70.







युनाइटेड इंडिया इंश्योरेंस कंपनी लिमिटेड  
UNITED INDIA INSURANCE COMPANY LTD.  
At United India, it's always U before I

## PROJECT COMPLETION LETTER

DATE: 27 MAY 2023

### TO WHOMSOEVER IT MAY CONCERN

This is to certify that Mr. PRAMODH M bearing Reg. No. 20NCJC833 of VI Semester B.Com student, The National College, Autonomous, Jayanagar, Bangalore has successfully completed the project work for the period of 06 weeks on 17 APRIL 2023 TO 27 MAY 2023 under the guidance of MR PRAKASH S UNITED INDIA INSURANCE LIMITED at our organisation towards the fulfilment of award of "Bachelor of Commerce" during the year 2022-23.

The title of his project work was "A STUDY ON MOTOR INSURANCE AND CUSTOMER SATISFACTION TOWARDS MOTOR INSURANCE AT UNITED INDIA INSURANCE".

During the period of his project with us he has exhibited punctuality and diligence. We wish him every success in life.

Thanking you.

For, UNITED INDIA INSURANCE COMPANY LIMITED



Authorised signatory

  
PRINCIPAL  
The National College  
Jayanagar, Bangalore-70.



Studio  
Unathi

Studio  
Unathi

ARCHITECTURE . INTERIORS . LANDSCAPE

## PROJECT COMPLETION LETTER

### TO WHOMSOEVER IT MAY CONCERN

This is to certify that PRAJWAL. V bearing Reg. No. 20NCJC832 of VI Semester B.Com student, The National College, Autonomous, Jayanagar, Bangalore has successfully completed the project work for the period of 04 weeks at STUDIO UNATHI under the guidance of Supreeth K. M at our organisation towards the fulfilment of the award of "Bachelor of Commerce" during the year 2023-24.

The title of his project work was "Customer Satisfaction"

During the period of her project with us she has exhibited punctuality and diligence. We wish her every success in life.

Thanking you,

*Supreeth K. M*  
PRINCIPAL  
The National College  
Jayanagar, Bangalore-70.





Studio  
Unathi

Studio  
Unathi

ARCHITECTURE . INTERIORS . LANDSCAPE

## PROJECT COMPLETION LETTER

### TO WHOMSOEVER IT MAY CONCERN

This is to certify that PRAJWAL. V bearing Reg. No. 20NCJC832 of VI Semester B.Com student, The National College, Autonomous, Jayanagar, Bangalore has successfully completed the project work for the period of 04 weeks at STUDIO UNATHI under the guidance of Supreeth K. M at our organisation towards the fulfilment of the award of "Bachelor of Commerce" during the year 2023-24.

The title of his project work was "Customer Satisfaction"

During the period of her project with us she has exhibited punctuality and diligence. We wish her every success in life.

Thanking you,

*Supreeth K. M*  
PRINCIPAL  
The National College  
Jayanagar, Bangalore-70.



# Karnataka Bank Ltd.

F. No. 1364

Estd.: 1924



BRANCH .....

Date

Your Ref.

Our Ref.

This is to certify that Prajwal S Reg No.20NCJC831 B.Com Final Year student of The National College, Autonomous, Jayanagar, Bangalore has successfully completed internship of six weeks under the guidance of Mr.Shashikanth at this organization, towards the fulfillment of the award of 'Bachelor of Commerce' during the year 2022-23.

During the period of his internship he has exhibited punctuality and diligence. We wish his every success in life.

For KARNATAKA BANK LTD.

  
Branch Manager  
Naganathapura Branch

Date: 02/11/22

Place: Naganathapura Electronic City Post, Bangalore-560100

  
PRINCIPAL  
The National College  
Jayanagar, Bangalore-70.





# Karnataka Bank Ltd.

F. No. 1304

Estd.: 1924



KARNATAKA BANK LTD.  
No. 75, Old, Seba Street, 2nd Floor, 1st  
Cross, Bangalore-560 002  
NAGANAATHAPURA, Bangalore-560 100

BRANCH NAGANAATHAPURA  
BANGALORE-560 100

Date

Your Ref.

Our Ref.

## TO WHOMSOEVER IT MAY CONCERN

This is to certify that Mr. Prajwal S bearing Reg. No. 20NCJC831 of VI Semester B.Com student, The National College, Autonomous, Jayanagar, Bangalore has successfully completed the project work for the period of 04 weeks (3<sup>rd</sup> April 2023 to 29<sup>th</sup> April 2023) under the guidance of Shashikanth Manager at our organization towards the fulfilment of award of "Bachelor of Commerce" during the year 2022-23.

The title of his project work was Home Loan in Karnataka bank.

During the period of his project with us he has exhibited punctuality and diligence. We wish him every success in life.

Thanking you.

For, Karnataka Bank Limited  
For KARNATAKA BANK LTD.

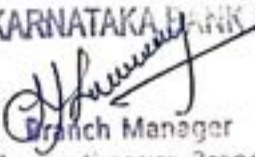
  
Branch Manager  
Naganaathapura Branch

  
PRINCIPAL  
The National College  
Jayanagar, Bangalore-70.



**Karnataka Bank Ltd.**

Estd.: 1924

BRANCH NAGANATHAPURA  
NAGANATHAPURA - 550 160

Date

Your Ref.

Our Ref.

Date: 21/09/22

To  
Dr. N K Satya Pal Sharma  
HOD- Department of Commerce  
The National College  
Autonomous  
Jayanagar, Bangalore- 70

Dear Sir,

**Subject: Internship Acceptance Letter - Nithin M (20NCJC830)**

This is to certify that Mr. Nithin M Reg. No.20NCJC830 has joined in our organisation on 21/09/22 and he will be working as internship trainee in our Karnataka Bank for the period of 45 days.

Thanking You

With Regards

FOR KARNATAKA BANK LTD.

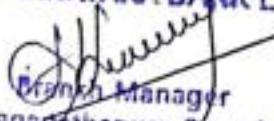
  
Branch Manager  
Naganathapura Branch

  
PRINCIPAL  
The National College  
Jayanagar, Bangalore-70.





830

# Karnataka Bank Ltd.

F. No. 1304

Estd.: 1924

**KARNATAKA BANK LTD.**  
No. 75, Opp. Sobha Silicon Oasis Aptmt,  
Doddanagamangala Road, Vinayak Nagar,  
Naganathapura, Electronic City Post,  
Bangalore-560100.



BRANCH **NAGANATHAPURA,**  
BANGALORE - 560100

Date

Your Ref.

Our Ref.

## TO WHOMSOEVER IT MAY CONCERN

This is to certify that Mr. Nithin M bearing Reg. No. 20NCJC830 of VI Semester B.Com student, The National College, Autonomous, Jayanagar, Bangalore has successfully completed the project work for the period of 04 weeks (3<sup>rd</sup> April 2023 to 29<sup>th</sup> April 2023) under the guidance of (Mr. Shashikanth Manager) at our organization towards the fulfilment of award of "Bachelor of Commerce" during the year 2022-23.

The title of his project work was Recent trends in banking in Karnataka bank.

During the period of his project with us he has exhibited punctuality and diligence. We wish him every success in life.

Thanking you.

For, Karnataka Bank Limited  
For KARNATAKA BANK LTD.

  
Branch Manager  
Naganathapura Branch

  
PRINCIPAL  
The National College  
Jayanagar, Bangalore-70.



## INTERNSHIP COMPLETION CERTIFICATE

This is to certify that Mr. NAVEEN KUMAR R, Reg No.20NCJC829, B.Com Final Year student of The National College, Autonomous, Jayanagar, Bangalore has successfully completed internship of 18 days under the guidance of Mr Ashok Savanth (Store Manager) at this organization (*Tanishq Bannerghatta Road*), towards the fulfillment of the award of '*Bachelor of Commerce*' during the year 2022-23.

During the period of his/her internship he/she has exhibited punctuality and diligence. We wish his/her every success in life.

*Ashok Savanth*



(Authorized signature with seal)

Date:

Place:

*D. Sush*

PRINCIPAL  
The National College  
Jayanagar, Bangalore-70.





## PROJECT COMPLETION LETTER

### TO WHOMSOEVER IT MAY CONCERN

This is to certify that Mr./Ms. NAVEEN KUMAR R bearing Reg. No. 20NCJC829 of VI Semester B.Com student, The National College, Autonomous, Jayanagar, Bangalore has successfully completed the project work for the period of 06 weeks 22/05/2023 - 14/06/2023 under the guidance of ARUN A HR at our organisation towards the fulfilment of award of "Bachelor of Commerce" during the year 2022-23.

The title of his/her project work was A PROJECT REPORT ON CONSUMER BEHAVIOUR.

During the period of his/her project with us he/she has exhibited punctuality and diligence. We wish him/her every success in life.

Thanking you.

For, DECATHLON

Authorized signatory with company seal



*[Handwritten Signature]*  
PRINCIPAL  
The National College  
Jayanagar, Bangalore-70.





ಶಂಕರ ಸೂಪರ್ ಸ್ಪೆಷಾಲಿಟಿ ಆಸ್ಪತ್ರೆ  
**SHANKAR**  
 SUPER SPECIALITY HOSPITAL



## INTERNSHIP COMPLETION CERTIFICATE

This is to certify that Ms. Monisha, S Reg No.20NCJCS28., B.ComFinal Year student of The National College, Autonomous, Jayanagar, Bangalore has successfully completed internship of six weeks under the guidance of Shankar Super Speciality Hospital at this organization, towards the fulfillment of the award of 'Bachelor of Commerce' during the year 2022-23.

During the period of her internship she has exhibited punctuality and diligence. We wish her every success in life.

(Authorized signature with seal)

**Managing Director**

Shankar Super Speciality Hospital  
 #68/5, Ganigrapalya  
 Grama Main Road, Vejarahalli,  
 Kanakapura Main Road,  
 Bengaluru-560062.

Date: 07/12/2022

Place:

**PRINCIPAL**  
 The National College  
 Jayanagar, Bangalore-70.



**TOLL FREE :**  
**1800 572 2544**





GINGER LAKE VIEW

PH: 9379791919 / 9035091919  
EMAIL: GINGERLAKEVIEW@GMAIL.COM  
GST: 29DMMPK2426PIZC

## PROJECT COMPLETION LETTER

### TO WHOMSOEVER IT MAY CONCERN

This is to certify that Mr./Ms.Monisha S bearing Reg. No.20NCJC828 of VI Semester B.Com student, The National College, Autonomous, Jayanagar, Bangalore has successfully completed the project work for the period of 06 weeks (Mention the dates) under the guidance of (Name & Designation of External guide) at our organisation towards the fulfilment of award of "Bachelor of Commerce" during the year 2022-23.

The title of his/her project work was Service Quality and customer Satisfaction.

During the period of his/her project with us he/she has exhibited punctuality and diligence. We wish him/her every success in life.

For Ginger Lake View Family Restaurant

  
Proprietor

For, (Ginger Lake View)

  
PRINCIPAL  
The National College  
Jayanagar, Bangalore-70

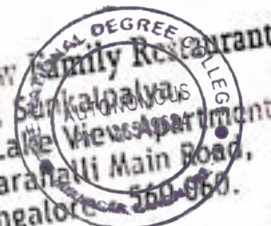
  
Ginger Lake View Family Restaurant  
No. 5714, Sankalpa  
Kengeri - Uttarahalli Main Road,  
Kengeri, Bangalore-560060.

Authorised signatory with company seal



# ಕರ್ನಾಟಕ ವಿದ್ಯುತ್ ಪ್ರಸರಣ ನಿಗಮ ನಿಯಮಿತ

Registered Electrical Supply (ಸಿ.ಐ.ಎಸ್) ಉ-40109ಕೆಎಂಇಎನ್‌ಸಿ/25591

ಮಾನವ ಸಂಪನ್ಮೂಲ ಅಭಿವೃದ್ಧಿ ಕೇಂದ್ರ, ಕೆ.ಪಿ.ಪ್ರ.ನಿ.ನಿ, ಹೂಡು ನಿರೀಕ್ಷಣೆ-550 048

ಕಾರ್ಯಾಲಯ ಸಂಖ್ಯೆ: 080 20040608

ಸಂಖ್ಯೆ: <https://kptel.karnataka.gov.in>

ಇ-ಮೇಲ್ ವಿಳಾಸ: [admin@kptel.karnataka.gov.in](mailto:admin@kptel.karnataka.gov.in)

ಕಂಪ್ಯೂಟರ್ ನೋಂದಣಿ ಸಂಖ್ಯೆ: 75/35590/22-23

1317-29

ದಿನಾಂಕ: 1 OCT 2022

## ಅಧಿಕೃತ ಜ್ಞಾಪನಾ ಪತ್ರ

ವಿಷಯ: "General Finance" ವಿಷಯದ ಕುರಿತಂತೆ ಕೆ.ಪಿ.ಪ್ರ.ನಿ.ನಿ. ನಿರೀಕ್ಷಣೆ ಕಛೇರಿ/ಕೆ.ಪಿ.ಪ್ರ.ನಿ.ನಿ. ಮಾನವ ಸಂಪನ್ಮೂಲ ಅಭಿವೃದ್ಧಿ ಕೇಂದ್ರ, ಹೂಡು ನಿರೀಕ್ಷಣೆ-550 048.

ಲಕ್ಷ್ಯ: ಡಿ ನ್ಯಾಷನಲ್ ಕಾಲೇಜ್, ಬೆಂಗಳೂರು ರವರ ಪತ್ರ ದಿನಾಂಕ: 20.09.2022

\*\*\*\*\*

ಡಿ ನ್ಯಾಷನಲ್ ಕಾಲೇಜ್, ಬೆಂಗಳೂರಿನಲ್ಲಿ ಬಿ.ಕಾಂ ಪದವಿಯಲ್ಲಿ ವ್ಯಾಸಂಗ ಮಾಡುತ್ತಿರುವ ಈ ಕೆಳಗಿನ ವಿದ್ಯಾರ್ಥಿಯು: ಶ್ರೀ ಕೆ. ಇ. ಪ್ರದೀಪ್, ನಿಯಂತ್ರಣಾಧಿಕಾರಿ(ಲೆಕ್ಕಗಳು ಓಂಟರಿ ಮತ್ತು ಮುಂಗಡ), ಕವಿಪ್ರನಿ, ಕಾಲೇರಿ ಭವನ, ಬೆಂಗಳೂರು ರವರ ಮಾರ್ಗದರ್ಶನದಲ್ಲಿ "General Finance" ಎಂಬ ವಿಷಯದ ಕುರಿತಂತೆ, ದಿನಾಂಕ: 03.10.2022 ರಿಂದ 15.11.2022 ರವರೆಗೆ ತರಬೇತಿಯನ್ನು ಪಡೆಯಲು ಈ ಕೆಳಗಿನ ಪಠ್ಯಕ್ರಮಗಳಿಗೆ ಒಳಪಟ್ಟಂತೆ ಅನುಮೋದನೆಯನ್ನು ನೀಡಲಾಗಿದೆ.

- ಸವಲ ತರಬೇತಿಯು ಯಾವುದೇ ರೀತಿಯಲ್ಲೂ ಕವಿಪ್ರನಿಯ ನಿಯಮಿತ ಕರ್ತವ್ಯಗಳನ್ನು ಅಡ್ಡಿಪಡಿಸಬಾರದು.
- ತರಬೇತಿ ಗಳಿಸಿದ ವಿದ್ಯಾರ್ಥಿಯು, ತರಬೇತಿಯು ಮುಗಿದ ನಂತರ ಅದರ ಮುಕ್ತಾಯ ವರದಿಯನ್ನು ಕಾಲೇಜಿಗೆ ತಿಳಿಸಿ ಮಾರ್ಗದರ್ಶಕರ ಸಹಿ, ಕವಿಪ್ರನಿಯ ಮಾರ್ಗದರ್ಶಕರ ಸಹಿ ಮತ್ತು ವಿದ್ಯಾರ್ಥಿಯ ಸಹಿಯನ್ನು ಒಳಗೊಂಡು ಈ ಕಛೇರಿಗೆ ಸಲ್ಲಿಸಬೇಕು.
- ನಿಗದಿತ 'ಎ' ನಮೂನೆಯಲ್ಲಿ ಕವಿಪ್ರನಿಯ ಮಾರ್ಗದರ್ಶಕರು ಸಹಿ ಮಾಡಿದ ತರಬೇತಿಯ ಪರಿಶೀಲನಾ ಪತ್ರ ಪೂರ್ಣಗೊಂಡ ದೃಢೀಕರಣ ಪತ್ರವನ್ನು ಈ ಕಛೇರಿಗೆ ಸಲ್ಲಿಸಿದ ನಂತರ, ಸಂಬಂಧಪಟ್ಟ ಕಾಲೇಜಿಗೆ ವಿದ್ಯಾರ್ಥಿಯ ತರಬೇತಿಯ ಪೂರ್ಣಗೊಂಡ ಬಗ್ಗೆ, ಈ ಕಛೇರಿಯಿಂದ ಪ್ರಮಾಣ ಪತ್ರವನ್ನು ನೀಡಲಾಗುವುದು.

ಕ್ರಮ ಸಂ	ವಿದ್ಯಾರ್ಥಿನಿಯರ ಹೆಸರು	ಯು.ಎಸ್.ಎನ್/ನೋಂದಣಿ ಸಂಖ್ಯೆ
1	ಮೊಹಮ್ಮದ್ ಅಶೀಶ್. ಕೆ.	20NCJC827

Kaushalya 11/10/2022  
21c ಆಡಳಿತಾಧಿಕಾರಿ

ಮಾನವ ಸಂಪನ್ಮೂಲ ಅಭಿವೃದ್ಧಿ ಕೇಂದ್ರ,  
ಕೆ.ಪಿ.ಪ್ರ.ನಿ.ನಿ, ಹೂಡು ನಿರೀಕ್ಷಣೆ-550 048

*[Handwritten Signature]*

PRINCIPAL

The National College  
Jaynagar, Bangalore-70.



ಪ್ರತಿಗಳು:

1. ಶ್ರೀ ಕೆ. ಇ. ಪ್ರದೀಪ್, ನಿಯಂತ್ರಣಾಧಿಕಾರಿ(ಲೆಕ್ಕಗಳು ಓಂಟರಿ ಮತ್ತು ಮುಂಗಡ), ಕವಿಪ್ರನಿ, ಕಾಲೇರಿ ಭವನ, ಬೆಂಗಳೂರು.
2. ಮುಖ್ಯಸ್ಥರು, ಡಿ ನ್ಯಾಷನಲ್ ಕಾಲೇಜ್, ಬೆಂಗಳೂರು.
3. ಸಂಬಂಧಪಟ್ಟ ವಿದ್ಯಾರ್ಥಿ/ ಸಿ.ಕಾ.ನಿ.ಇಂ(ಎ)-2/ ಕೆ.ಪ್ರ./ ಮು.ಕ.





## PROJECT COMPLETION LETTER

Date: 17.04.2023

### TO WHOMSOEVER IT MAY CONCERN

This is to certify that **Mr. Muhammad Ashik. K** bearing Reg. No. **20NCJC827** of VI Semester B.Com student, The National College, Autonomous, Jayanagar, Bangalore has successfully completed the project work for the period of 04 weeks **18.04.2023 to 18.05.2023** under the guidance of **Mr. NASAR (Manager)** at our organisation towards the fulfilment of award of "Bachelor of Commerce" during the year 2022-23.

The title of his project work was **A Study on the impact of E-Commerce on Retail market ShopRite hypermarket.**

During the period of his project with us he has exhibited punctuality and diligence. We wish him every success in life.

Thanking you

**SHOPRITE HYPERMARKET**

Mr. NASAR (Manager)  
283, Puttalingiah road  
Near Carmel school  
Padmanabhanagar  
Bangalore- 560070

PRINCIPAL  
The National College  
Jayanagar, Bangalore-70.



# Karnataka Bank Ltd.

Estd.: 1924



KARNATAKA BANK LTD.  
No. 75, Opp. Sobha Silicon Oasis Aptmt,  
Doddanagomangala Road, Vinayak Nagar,  
Bangalore-560100.

BRANCH NAGANAATHAPURA.....  
BANGALORE-560100

Date

Your Ref.

Our Ref.

## TO WHOMSOEVER IT MAY CONCERN

This is to certify that Mr. MANOJ K bearing Reg. No. 20NCJC825 of VI Semester B.Com student, The National College, Autonomous, Jayanagar, Bangalore has successfully completed the project work for the period of 04 weeks (3<sup>rd</sup> April to 29<sup>th</sup> April) under the guidance of (Shashikanth, Manager) at our organization towards the fulfilment of award of "Bachelor of Commerce" during the year 2022-23.

The title of his project work was Role Bank Finance in growth of MSME sector.

During the period of his project with us he has exhibited punctuality and diligence. We wish him every success in life.

Thanking you.

For, Karnataka Bank Limited  
For KARNATAKA BANK LTD.

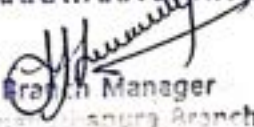
  
Branch Manager  
Naganaathapura Branch

  
PRINCIPAL  
The National College  
Jayanagar, Bangalore-70.



Regd. & Head Office : Mangalore - 575 002, India



# Karnataka Bank Ltd.

Estd.: 1924



KARNATAKA BANK LTD.  
No. 75, Opp. Sobha Silicon Oasis Aptmt,  
Doddanagomangala Road, Vinayak Nagar,  
Bangalore-560100.

BRANCH NAGANAATHAPURA.....  
BANGALORE-560100

Date

Your Ref.

Our Ref.

## TO WHOMSOEVER IT MAY CONCERN

This is to certify that Mr. MANOJ K bearing Reg. No. 20NCJC825 of VI Semester B.Com student, The National College, Autonomous, Jayanagar, Bangalore has successfully completed the project work for the period of 04 weeks (3<sup>rd</sup> April to 29<sup>th</sup> April) under the guidance of (Shashikanth, Manager) at our organization towards the fulfilment of award of "Bachelor of Commerce" during the year 2022-23.

The title of his project work was Role Bank Finance in growth of MSME sector.

During the period of his project with us he has exhibited punctuality and diligence. We wish him every success in life.

Thanking you.

For, Karnataka Bank Limited  
For KARNATAKA BANK LTD.

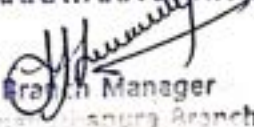
  
Branch Manager  
Naganaathapura Branch

  
PRINCIPAL  
The National College  
Jayanagar, Bangalore-70.



Regd. & Head Office : Mangalore - 575 002, India

## INTERNSHIP COMPLETION CERTIFICATE

This is to certify that Mr. MANJU S, Reg No.20NCJC824, B.Com Final Year student of The National College, Autonomous, Jayanagar, Bangalore has successfully completed internship of 24 days under the guidance of Mr Ashok Savanth (Store Manager) at this organization (*Tanishq Bannerghatta Road*), towards the fulfillment of the award of 'Bachelor of Commerce' during the year 2022-23.

During the period of his/her internship he/she has exhibited punctuality and diligence. We wish his/her every success in life.

*Ashok Savanth*



(Authorized signature with seal)

Date:

Place:

*D. Sush*

PRINCIPAL  
The National College  
Jayanagar, Bangalore-70





## TO WHOMSOEVER IT MAY CONCERN

This is to certify that Mr. Manju. S, bearing Reg.No. 20NCJC824 of VI Semester B.Com student, The National College, Autonomous, Jayanagar, Bangalore has successfully completed the project work for the period of 6 weeks, From 15/05/2023 to 17/06/2023 under the guidance of (DHARAMVEER, MARKETING HEAD) at our organisation towards the fulfilment of award of "Bachelor of Commerce" during the year 2022-23.

The title of his project work was effects of good public relation & organization promotion achievement of marketing object

During the period of his project with us he has exhibited punctuality and diligence. We wish his every success in life.

Thank you,

For,

Reliance Mart

*Dharam Veer*

**RELIANCE RETAIL LIMITED**  
Bhartiya City Centre, Thanisandra,  
Bangalore, Kamataka - 560 077

*D. Sush*

**PRINCIPAL**  
**The National College**  
Jayanagar, Bangalore-70.



**Reliance Retail Ventures Limited**

CIN: U51909MH2006PLC1661 Phone: +91 22 35553800

Registered office: 4<sup>th</sup> Floor, court House, Lokmanya task Mang Dhobi, Mumbai-400 002. India



## PROJECT COMPLETION LETTER

DATE:

### TO WHOMSOEVER IT MAY CONCERN

This is to certify that Mr. MADHU G bearing Reg. No. 20NCJC823 of VI Semester B.Com student, The National College, Autonomous, Jayanagar, Bangalore has successfully completed the project work for the period of 06 weeks on 22 MAY 2023 under the guidance of MAHESH K Human resources BRITANNIA at our organisation towards the fulfilment of award of "Bachelor of Commerce" during the year 2022-23.

The title of his/her project work was " FINANCIAL ANALYSIS OF BRITANNIA INDUSTRIES" .

During the period of his project with us he has exhibited punctuality and diligence. We wish him every success in life.

Thanking you.

For, BRITANNIA

Authorised signator

PRINCIPAL  
The National College  
Jayanagar, Bangalore-70.







## PROJECT COMPLETION LETTER

DATE:

### TO WHOMSOEVER IT MAY CONCERN

This is to certify that Mr. MADHU G bearing Reg. No. 20NCJC823 of VI Semester B.Com student, The National College, Autonomous, Jayanagar, Bangalore has successfully completed the project work for the period of 06 weeks on 22 MAY 2023 under the guidance of MAHESH K Human resources BRITANNIA at our organisation towards the fulfilment of award of "Bachelor of Commerce" during the year 2022-23.

The title of his/her project work was " FINANCIAL ANALYSIS OF BRITANNIA INDUSTRIES" .

During the period of his project with us he has exhibited punctuality and diligence. We wish him every success in life.

Thanking you.

For, BRITANNIA

Authorised signator

PRINCIPAL  
The National College  
Jayanagar, Bangalore-70.



# **SRSV AGRO COMPANY**

# 19, Plat Form Road  
Bengaluru - 560 020  
Ph : 080-23566055  
Mob : 9108150223

## **INTERNSHIP COMPLETION CERTIFICATE**

This is to certify that Mr.Mallesh B, Register No.20NCJC822, B.com Final Year student of The National College, Autonomous, Jayanagar, Bangalore has Successfully Completed Internship of 06 days Under the Guidance of \_\_\_\_\_ At Tanishq Vegacity Caratlane, Towards the fulfillment of the award of 'Bachelor of Commerce' during the year of 2022 - 23.

During the period of his internship he exhibited punctuality and diligence. We wish his every success in life.

Date :02/11/2022

Place:Bangalore



Hr-Executive

Tanishq Jayanagar

For SRSV AGRO COMPANY

Partner



PRINCIPAL  
The National College  
Jayanagar, Bangalore-70.



Show Room : Vega City Mall, Unit No. G-10, No. 172/1, Srinivasa Industrial Estate  
Bannerghatta Road, Bengaluru - 560 076



Mobile : 990281500

# P. C. M. DENTAL SUPPLY

DENTAL MATERIALS, INSTRUMENTS & EQUIPMENTS  
#1, 2nd Main, 3rd Cross, Chamarajpet, Near Bata Show Room, BANGALORE-560 018.  
Email : pcmdentalsupply@gmail.com

Ref. No. :

Date : .....

## PROJECT COMPLETION LETTER

### TO WHOMSOEVER IT MAY CONCERN

This is to certify that Mr./Ms. MALLESH.B bearing Reg. No. 20NCJC822 of VI Semester B.Com student, The National College, Autonomous, Jayanagar, Bangalore has successfully completed the project work for the period of 06 weeks (6/4/2023 TO 15/5/2023) under the guidance of (SHUBHA SAGAR.H - B.COM GRADUATE) at our organisation towards the fulfilment of award of "Bachelor of Commerce" during the year 2021-22.

The title of his/her project work was : The impact of sales promotion on marketing of new product and services.

During the period of his/her project with us he/she has exhibited punctuality and diligence. We wish him/her every success in life.

Thanking you.

For P.C.M. DENTAL SUPPLY  
N. Sathya  
Proprietor

Authorised signatory with company seal

S. Shubha  
PRINCIPAL  
The National College  
Jayanagar, Bangalore-70.



# SRSV AGRO COMPANY

# 8/69, 'Prabhat Complex'  
Kempgowda Road  
Bengaluru - 560 009

## INTERNSHIP COMPLETION CERTIFICATE

This is to certify that Ms. Madhu shree P, Register No.20NCJC821, B.com Final Year student of The National College, Autonomous, Jayanagar, Bangalore has Successfully Completed Internship of 16 days Under the Guidance of Anagha At Tanishq Vegacity Caratlane, Towards the fulfillment of the award of 'Bachelor of Commerce' during the year of 2022 - 23.

During the period of her internship she exhibited punctuality and diligence. We wish her every success in life.

Date :02/11/2022

Place:Bangalore



Hr-Executive

Tanishq Jayanagar

SRSV AGRO COMPANY

Partner

  
PRINCIPAL  
The National College  
Jayanagar, Bangalore-70.



Show Room : No. 83/2, 9th Main Road, 4th Block, Jayanagar, BENGALURU - 560 011  
Mob : 7338273383



# CORETECENGINEERINGINDIA PVT.LTD.

(Subsidiary of Yuken India Limited)



Regional Office:  
S.S. Narasandra Industrial  
Estate, Whitefield Road,  
Mahadevapura Post Bangalore-  
560025  
E-Mail:

Plant-III, Plot No. 263, 263 & 264,  
Malaru Rd. Phase Industrial  
Area, Kadib Road No. 7, Malaru  
Taluk, Malaru, Kolar District -563130  
Karnataka (India) Mobile No: +91-9740702948  
Email: Rajaraman.de@Coretecengg.com

## TO WHOMEVER IT MAY CONCERN

This is to certify that **Ms. MADHUSHREE** bearing Reg. No. 20NCJCS21 of VI Semester B.Com student, The National College, Autonomous, Jayanagar, Bangalore has successfully completed the project work for the period of 06 weeks 12th April 2023 to 22st May 2023 under the guidance of Mr. Kantha, Manager at our Organization towards the fulfilment of award of "Bachelor of Commerce" during the year 2022-23.

The title of her project work was "A Study On Impact Of Mechanisation On Labour Turnover"

During the period of her project with us she has exhibited punctuality and diligence. We wish her every success in life.

Thanking you,

For

Coretec Engineering Pvt. Ltd

For: CORETEC ENGG. INDIA PVT. LTD \*

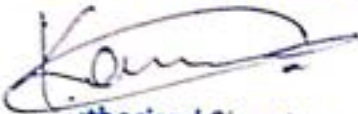
  
Authorized Signatory

  
PRINCIPAL  
The National College  
Jayanagar, Bangalore-70.





75  
ಸ್ವಾತಂತ್ರ್ಯ  
ಅಭಿಮಾನ ದಿನೋತ್ಸವ

## ಕರ್ನಾಟಕ ವಿದ್ಯುತ್ ಪ್ರಸರಣ ನಿಗಮ ನಿಯಮಿತ

ನಿಗಮದ ಗುರುತಿನ ಸಂಖ್ಯೆ (ಸಿ.ಎ.ಎಸ್): ಯು40109ಕಎ999ಎಸ್‌ಪಿ02521

ಮಾನವ ಸಂಪನ್ಮೂಲ ಅಭಿವೃದ್ಧಿ ಕೇಂದ್ರ, ವೈಟ್‌ಫೀಲ್ಡ್ ರಸ್ತೆ, ಹೂಡಿ ಬೆಂಗಳೂರು-560 048

ಪೂರೈಕೆ ಸಂಖ್ಯೆ : 090-28540666

www.kptcl.karnataka.gov.in

ಇ-ಮೇಲ್ ವಿಳಾಸ [adminhrdckptcl@gmail.com](mailto:adminhrdckptcl@gmail.com)

ಸಂಖ್ಯೆ: ಕವಿಪ್ರನಿ/ಮಾ.ಸಂ.ಅ.ಕೇಂದ್ರ/75/35590/22-23/1330-32

ದಿನಾಂಕ : 1 OCT 2022

### ಅಧಿಕೃತ ಜ್ಞಾಪನಾ ಪತ್ರ

ವಿಷಯ: "General Finance" ವಿಷಯದ ಕುರಿತಂತೆ ಕ.ವಿ.ಪ್ರ.ನಿ.ನಿ ಯಲ್ಲಿ ತರಬೇತಿಯನ್ನು ಮಾಡಲು ಅನುಮೋದನೆಯನ್ನು ನೀಡುವ ಬಗ್ಗೆ.

ಉಲ್ಲೇಖ: ದಿ ನ್ಯಾಷನಲ್ ಕಾಲೇಜ್, ಬೆಂಗಳೂರು ರವರ ಪತ್ರ ದಿನಾಂಕ: 20.09.2022

\*\*\*\*\*

ದಿ ನ್ಯಾಷನಲ್ ಕಾಲೇಜ್, ಬೆಂಗಳೂರಿನಲ್ಲಿ ಐ.ಕಾಂ ಪದವಿಯಲ್ಲಿ ವ್ಯಾಸಂಗ ಮಾಡುತ್ತಿರುವ ಈ ಕೆಳಕಂಡ ವಿದ್ಯಾರ್ಥಿಯು, ಶ್ರೀ ಕೆ. ಇ. ಪ್ರದೀಪ್, ನಿಯಂತ್ರಣಾಧಿಕಾರಿ(ಲೆಕ್ಕಗಳು ಮತ್ತು ಮುಂಗಡ), ಕವಿಪ್ರನಿ, ಕಾವೇರಿ ಭವನ, ಬೆಂಗಳೂರು ರವರ ಮಾರ್ಗದರ್ಶನದಲ್ಲಿ "General Finance" ಎಂಬ ವಿಷಯದ ಕುರಿತಂತೆ, ದಿನಾಂಕ: 03.10.2022 ರಿಂದ 15.11.2022 ರವರೆಗೆ ತರಬೇತಿಯನ್ನು ಪಡೆಯಲು ಈ ಕೆಳಗಿನ ಪರಶುಗಳಿಗೆ ಒಳಪಟ್ಟಂತೆ ಅನುಮೋದನೆಯನ್ನು ನೀಡಲಾಗಿದೆ.

- ಸದರಿ ತರಬೇತಿಯು ಯಾವುದೇ ರೀತಿಯಲ್ಲೂ ಕವಿಪ್ರನಿಯ ನಿಯಮಿತ ಕರ್ತವ್ಯಗಳನ್ನು ಅಡ್ಡಿಪಡಿಸಬಾರದು.
- ತರಬೇತಿ ಗಳಿಸಿದ ವಿದ್ಯಾರ್ಥಿಯು, ತರಬೇತಿಯು ಮುಗಿದ ನಂತರ ಅದರ ಮುಕ್ತಾಯ ಪದವಿಯನ್ನು ಕಾಲೇಜಿನ ಅಂತರಿಕ ಮಾರ್ಗದರ್ಶಕರ ಸಹಿ, ಕವಿಪ್ರನಿಯ ಮಾರ್ಗದರ್ಶಕರ ಸಹಿ ಮತ್ತು ವಿದ್ಯಾರ್ಥಿಯ ಸಹಿಯನ್ನು ಒಳಗೊಂಡು ಈ ಕಛೇರಿಗೆ ಸಲ್ಲಿಸತಕ್ಕದ್ದು.
- ನಿಗದಿತ 'ಎ' ನಮೂನೆಯಲ್ಲಿ ಕವಿಪ್ರನಿಯ ಮಾರ್ಗದರ್ಶಕರು ಸಹಿ ಮಾಡಿದ ತರಬೇತಿಯ ಪರಿಶೀಲನಾ ಮತ್ತು ಪೂರ್ಣಗೊಂಡ ದೃಢೀಕರಣ ಪತ್ರವನ್ನು ಈ ಕಛೇರಿಗೆ ಸಲ್ಲಿಸಿದ ನಂತರ, ಸಂಬಂಧಪಟ್ಟ ಕಾಲೇಜಿಗೆ ವಿದ್ಯಾರ್ಥಿಯ ತರಬೇತಿಯ ಪೂರ್ಣಗೊಂಡ ಬಗ್ಗೆ, ಈ ಕಛೇರಿಯಿಂದ ಪ್ರಮಾಣ ಪತ್ರವನ್ನು ನೀಡಲಾಗುವುದು.

ಕ್ರಮ ಸಂ	ವಿದ್ಯಾರ್ಥಿನಿಯರ ಹೆಸರು	ಯು.ಎಸ್.ಎನ್/ನೋಂದಣಿ ಸಂಖ್ಯೆ
1	ಕಿಶೋರ್. ಜಿ. ಎಂ.	20NCJC819

Kaushal 11/10/2022  
a/c ಆಡಳಿತಾಧಿಕಾರಿ

ಮಾನವ ಸಂಪನ್ಮೂಲ ಅಭಿವೃದ್ಧಿ ಕೇಂದ್ರ,

ಕ.ವಿ.ಪ್ರ.ನಿ.ನಿ, ಹೂಡಿ, ಬೆಂಗಳೂರು

ಪ್ರತಿಗಳು:

1. ಶ್ರೀ ಕೆ. ಇ. ಪ್ರದೀಪ್, ನಿಯಂತ್ರಣಾಧಿಕಾರಿ(ಲೆಕ್ಕಗಳು ಮತ್ತು ಮುಂಗಡ), ಕವಿಪ್ರನಿ, ಕಾವೇರಿ ಭವನ, ಬೆಂಗಳೂರು.
2. ಮುಖ್ಯಸ್ಥರು, ದಿ ನ್ಯಾಷನಲ್ ಕಾಲೇಜ್, ಬೆಂಗಳೂರು.
3. ಸಂಬಂಧಪಟ್ಟ ವಿದ್ಯಾರ್ಥಿ/ ಸ.ಕಾ.ನಿ.ಇಂ(ಎ)-2/ ಕ.ಪ್ರ./ ಮು.ಕ.

*[Signature]*  
PRINCIPAL

The National College,  
Jayanagar, Bangalore-70.







ভারতীয় স্টেট বেঙ্ক  
भारतीय स्टेट बैंक  
State Bank Of India

The Chief Manager/Branch manager  
State Bank of India  
Branches - Bangalore  
Ref. No. R-I/HR/2022-23

Date:

TO WHOMSOEVER IT MAY CONCERN

This is to certify that Mr. KISHORE GM bearing Reg. No. 20NCJC819 of VI Semester B.Com student, The National College, Autonomous, Jayanagar, Bangalore has successfully completed the project work for the period of 06 weeks from 24 April 2023 to 06 June 2023 under the guidance of Mr. JAY PRAKASH BRANCH MANAGER at our organization towards the fulfilment of award of "Bachelor of Commerce" during the year 2022-23.

The title of his project work was "STUDY ON NON-PERFORMING ASSETS IN STATE BANK OF INDIA".

During the period of his project with us he has exhibited punctuality and diligence. We wish him every success in life.

Thanking you.

For, STATE BANK OF INDIA



*J. Sush*  
PRINCIPAL  
The National College  
Jayanagar, Bangalore-70.



Authorised signatory

# SRSV AGRO COMPANY

# 8/69, 'Prabhat Complex'  
Kempegowda Road  
Bengaluru - 560 009

## INTERNSHIP COMPLETION CERTIFICATE

This is to certify that Mr.Karthik S , Register No.20NCJC817, B.com Final Year student of The National College, Autonomous, Jayanagar, Bangalore has Successfully Completed Internship of 18 days Under the Guidance of Mr. Kishan At Mia Tanishq Jayanagar, Towards the fulfillment of the award of 'Bachelor of Commerce' during the year of 2022 - 23.

During the period of his internship he exhibited punctuality and diligence. We wish his every success in life.

Date :02/11/2022

Place:Bangalore



Hr-Executive

Tanishq Jayanagar

For SRSV AGRO COMPANY

Partner

  
PRINCIPAL  
The National College  
Jayanagar, Bangalore-70.





**PROJECT COMPLETION LETTER**

Date: 22/5/23

TO WHOMSOEVER IT MAY CONCERN

This is to certify that Mr./Ms. KARTHIK S bearing Reg. No. 20NCJC817 of VI Semester B.Com student, The National College, Autonomous, Jayanagar, Bangalore has successfully completed the project work for the period of 06 weeks on 22 MAY 2023 under the guidance of BHANU PRAKASH (HR) DECATHLON at our organisation towards the fulfilment of award of "Bachelor of Commerce" during the year 2022-23.

The title of his/her project work was " THE IMPACT OF E-COMMERCE IN EMERGING MARKET" [Decathlon]

During the period of his project with us he has exhibited punctuality and diligence. We wish him every success in life.

Thanking you.

For, DECATHLON

  
Authorized Signatory

  
PRINCIPAL  
The National College  
Jayanagar, Bangalore-70.



# MOBILES TYRE TECH

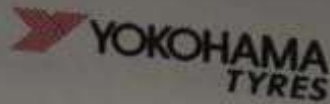

Kammanhalli Main road, St Thomas Town Post, Bangalore-560084  
Off: 080-25452916 / 25426465

E-mail: [mobilestiretech@gmail.com](mailto:mobilestiretech@gmail.com)

[www.mobilestyretech.co](http://www.mobilestyretech.co) [www.mobilestyretech.in](http://www.mobilestyretech.in)

REF. \_\_\_\_\_

DATE.....

## CERTIFICATE

This is to certify that Mr. KARAN G FROM THE NATIONAL COLLEGE JAYNAGAR Bangalore karnataka has successfully completed his project during 8<sup>th</sup> june to 10<sup>th</sup> july 2023. This project was undertaken by him in MOBILES TYRE TECH (YOKOHAMA) titled as "WORKING CAPITAL". This project on evaluation fulfills all the stated criteria and the student's finding are his original work.

I hereby certify that his work was excellent to the best of my knowledge.

We wish him all the best in his future endeavors.

For Mobiles Tyre Tech

Proprietor

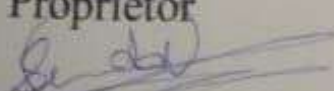
  
Senior Manager

  
PRINCIPAL  
The National College  
Jaynagar, Bangalore-70





# MOBILES TYRE TECH

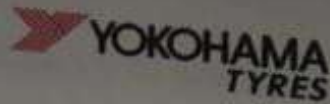

Kammanhalli Main road, St Thomas Town Post, Bangalore-560084  
Off: 080-25452916 / 25426465

E-mail: [mobilestiretech@gmail.com](mailto:mobilestiretech@gmail.com)

[www.mobilestyretech.co](http://www.mobilestyretech.co) [www.mobilestyretech.in](http://www.mobilestyretech.in)

REF. \_\_\_\_\_

DATE.....

## CERTIFICATE

This is to certify that Mr. KARAN G FROM THE NATIONAL COLLEGE JAYNAGAR Bangalore karnataka has successfully completed his project during 8<sup>th</sup> june to 10<sup>th</sup> july 2023. This project was undertaken by him in MOBILES TYRE TECH (YOKOHAMA) titled as "WORKING CAPITAL". This project on evaluation fulfills all the stated criteria and the student's finding are his original work.

I hereby certify that his work was excellent to the best of my knowledge.

We wish him all the best in his future endeavors.

For Mobiles Tyre Tech

Proprietor

  
Senior Manager

  
PRINCIPAL  
The National College  
Jaynagar, Bangalore-70





# HARINI HATCHERIES & FARMS PVT LTD.

## ACCEPTANCE LETTER

Date: 26/09/2022

To  
Dr. N K Satya Pal Sharma  
HOD- Department of Commerce  
The National College  
Autonomous  
Jayanagar, Bangalore- 70

Dear Sir,

**Subject: Internship Acceptance Letter - Harshitha M K,  
Reg. No.20NCJC815**

This is to certify that Ms. Harshitha M K, Reg No.20NCJC815, has joined our organization on 26<sup>th</sup> September, 2022 and she will be working as internship trainee in our Company Harini Hatcheries & Farms Pvt Ltd. for the period of 45 days.

Thanks with regards

For Harini Hatcheries & Farms Pvt. Ltd.

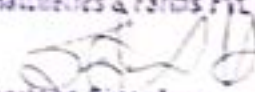
  
Authorized Signatory

  
PRINCIPAL  
The National College  
Jayanagar, Bangalore-70.





# PARAMOUNT

EXPECT MORE...

PROJECT COMPLETION LETTER

27 May 2023

TO WHOMSOEVER IT MAY CONCERN

This is to certify that Ms. HARSHITHA M K bearing Reg. No. 20NCJC815 of VI Semester B.Com student, The National College, Autonomous, Jayanagar, Bangalore has successfully completed the project work for the period of 06 weeks on 17 APRIL 2023 TO 27 MAY 2023 under the guidance of MR. SATHVIK P PARAMOUNT INDUSTRIES PVT LTD at our organization towards the fulfillment of the award of "Bachelor of Commerce" during the year 2022-23.

The title of her project work was "A PROJECT ON RECRUITMENT SELECTION PROCESS OF PARAMOUNT INDUSTRIES PVT. LTD".

During the period of her project with us she has exhibited punctuality and diligence. We wish her every success in life.

Thank you.



PARAMOUNT INDUSTRIES  
No. 87, 3rd Cross, Electronic City Phase 1,  
Bangalore - 560100

*[Signature]*  
PRINCIPAL  
The National College  
Jayanagar, Bangalore-70.



## INTERNSHIP COMPLETION CERTIFICATE

This is to certify that Mr.HARIPRASAD KS, Reg No.20NCJC814, B.Com Final Year student of The National College, Autonomous, Jayanagar, Bangalore has successfully completed internship of 10 days under the guidance of Mr Ashok Savanth (Store Manager)at this organization (*Tanishq Bannerghatta Road*), towards the fulfillment of the award of '*Bachelor of Commerce*' during the year 2022-23.

During the period of his/her internship he/she has exhibited punctuality and diligence. We wish his/her every success in life.

(Authorized signature with seal)

Date:

Place:

  
PRINCIPAL  
The National College  
Jayanagar, Bangalore-70.

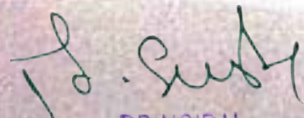



**PROJECT COMPLETION LETTER**

This is to certify that Mr. **HARI PRASAD K S** Bearing Reg. No. **20NCJC814** of VI Semester B. Com student, The National College, Autonomous, Jayanagar, Bangalore has successfully completed the project work for the period of 04 weeks commencing from 02/05/2023 to 31/05/2023 under the guidance of Mr. **VISHNU SURESH** at our organization towards the fulfillment of award of "Bachelor of Commerce" during the year 2022-23.

The title of his/her project work was: **GREEN BANKING** in **PUNJAB NATIONAL BANK**.

During the period of his project with us he has exhibited punctuality and diligence. We wish him every success in life.

Thanking you.

धुले पंजाब नैशनल बैंक  
For Punjab National Bank

प्रबन्धक / Manager  
सी एम रोड ब्रांच इंदिरानगर बंगलूर  
CMH Road Branch, Indiranagar Bangalore-35



*V. Suresh*  
PRINCIPAL  
The National College  
Jayanagar, Bangalore-70.





# SRSV AGRO COMPANY

# 8/69, 'Prabhat Complex'  
Kempegowda Road  
Bengaluru - 560 009

## INTERNSHIP COMPLETION CERTIFICATE

This is to certify that Mr. Harshavardhan Rao N , Register No.20NCJC813, B.com Final Year student of The National College, Autonomous, Jayanagar, Bangalore has Successfully Completed Internship of 18 days Under the Guidance of At Tanishq Caratlane Jayanagar, Towards the fulfillment of the award of 'Bachelor of Commerce' during the year of 2022 - 23.

During the period of his internship he exhibited punctuality and diligence. We wish his every success in life.

Date :02/11/2022

Place:Bangalore

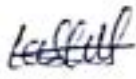
  
Hr-Executive

Tanishq Jayanagar

  
PRINCIPAL

The National College  
Jayanagar, Bangalore-70



Partner

Show Room : No. 83/2, 9th Main Road, 4th Block, Jayanagar, BENGALURU - 560 011

Mob : 7338273383

## PROJECT COMPLETION LETTER

### TO WHOMSOEVER IT MAY CONCERN

This is to certify that Mr./Ms. HARSHAVARDHAN RAO N bearing Reg. No. 20NCIC813 of VI Semester B.Com student, The National College, Autonomous, Jayanagar, Bangalore has successfully completed the project work for the period of 06 weeks under the guidance of Mr.Vishwanath Rao at our organisation towards the fulfilment of award of "Bachelor of Commerce" during the year 2022-23.

The title of his/her project work was Consumer Perception towards Social Media Marketing.

During the period of his/her project with us he/she has exhibited punctuality and diligence. We wish him/her every success in life.

Thanking you.

For,

VSM Software and Digital Media Technologies

Authorised signatory with company seal



*[Handwritten Signature]*  
PRINCIPAL  
The National College  
Jayanagar, Bangalore-70.





Innovation has a name.

Plot No. 300, Phase – 2, KIADB Industrial Area, Harohalli, Taluka Kanakpura, Karnataka – 562112

**TO WHOMSOEVER IT MAY CONCERN**

This is to certify that Mr. **Dhanush.M** bearing Reg. No **20NCJC812** of VI Semester B.Com student, The National College, Autonomous, Jayanagar, Bangalore has successfully completed the project work for the period of 06 weeks 2/5/2023 to 30/5/2023 under the guidance of **JAGGA REDDY – MARKETING HEAD** at our organisation towards the fulfilment of award of "Bachelor of Commerce" during the year 2021-22.

The title of his project work was **Marketing plan and budget**

During the period of his project with us he has exhibited punctuality and diligence. We wish him every success in life.

Thanking you.



Authorised signatory with company seal

*[Handwritten Signature]*  
PRINCIPAL  
The National College  
Jayanagar, Bangalore-70.





## INTERNSHIP COMPLETION CERTIFICATE

This is to certify that Mr.DILIP S, Reg No.20NCJC811, B.Com Final Year student of The National College, Autonomous, Jayanagar, Bangalore has successfully completed internship of 10 days under the guidance of Mr Ashok Savanth (Store Manager)at this organization (*Tanishq Bannerghatta Road*), towards the fulfillment of the award of '*Bachelor of Commerce*' during the year 2022-23.

During the period of his/her internship he/she has exhibited punctuality and diligence. We wish his/her every success in life.

(Authorized signature with seal)

Date:

Place:

  
PRINCIPAL  
The National College  
Jayanagar, Bangalore-70.





**TO WHOMSOEVER IT MAY CONCERN**

This is to certify that Mr. Dilip. S, bearing Reg.No. 20NCJC811 of VI Semester B.Com student, The National College, Autonomous, Jayanagar, Bangalore has successfully completed the project work for the period of 6 weeks, From 17/04/2023 to 20/05/2023 under the guidance of (NEERAJ SHARMA) at our organisation towards the fulfilment of award of "Bachelor of Commerce" during the year 2022-23

The title of his project work was Market survey of McDonald's

During the period of his project with us he has exhibited punctuality and diligence. We wish his every success in life.

Thank you,

For,

McDonald's

*D. Suresh*  
PRINCIPAL  
The National College  
Jayanagar, Bangalore-70.

Stamp: NATIONAL DEGREE COLLEGE  
AUTONOMOUS  
Ph 26549684  
JAYANAGAR, BANGALORE

**S.J.S. Enterprises Limited**

Formerly known as S.J.S. Enterprises Private Limited  
Ss No 28-71a of Aja Village and Ss No 75/7b  
of BM Road Village, Kengeri Hobli, Bangalore-560072  
P. +91 80 21940777 F. +91 80 28425110  
Email: info@sjsindia.com, compliance@sjsindia.com

ISO 9001 ISO 45001  
EN45001 IAF 10049  
Certified  
CIN: L51907KA2005PLC036601  
www.sjsindia.com



SJS/HRM/PRJ CER/F36/ - R3834

December 13, 2022

**TO WHOM IT MAY CONCERN**

This is to certify that Ms. Deeksha C Reg no: 20NCJC810 student of of 5th Semester B Com from The National Degree College Jayanagar .She has successfully completed his Project titled "Organizations Study" Starting from 10-10-2022 to 04-11-2022.

Deeksha C displayed a professional character during his project and completed all her assigned tasks, during her project program with us, She was found self-motivated, hardworking, and inquisitive.

We wish her all the best for future endeavours.

For SJS Enterprises Limited,

*S. Umadevi*

S. Umadevi

AGM - HR & Admin



*D. Sush*

PRINCIPAL

The National College  
Jayanagar, Bangalore-70.







**PROJECT COMPLETION LETTER  
TO WHOMSOEVER IT MAY CONCERN**

This is to certify that Mr./Ms. Decksha C bearing Reg. No. 20NCJC810 of VI Semester B. Com student, The National College, Autonomous, Jayanagar, Bangalore has successfully completed the project work for the period of 06 weeks 02/05/2023 to 31/05/2023 under the guidance of Vijayakumar accounts manager of External guide at our organisation towards the fulfilment of award of "Bachelor of Commerce" during the year 2021-22.

The title of his/her project work was Employment welfare benefits.

During the period of his/her project with us he/she has exhibited punctuality and diligence. We wish him/her every success in life.

Thanking you.

For, Greenchef Appliances Limited

Authorised signatory



PRINCIPAL

The National College  
Jayanagar, Bangalore-70

**Greenchef Appliances Limited**

HEAD OFFICE: No. 477E, 12th Cross, 3rd Main Road, Peenya, 4th Phase, Opp. Bata Factory,  
Next to Shivapura Lake, Bengaluru, Karnataka - 560058

CIN No: U29300KA2016PLC05411B





# Swemed Biomedicals Pvt. Ltd.

29/1 first floor, Chunchanaghatta Cross, Yelachenahalli, Bengaluru 560062

## ACCEPTANCE LETTER

DATE: 9/10/2022

To  
Dr. N K Satya Pal Sharma  
HOD- Department of Commerce  
The National College  
Autonomous  
Jayanagar, Bangalore- 70

Dear sir,

Subject: Internship Acceptance Letter – DARSHAN.N.S. Reg No: 20NCJC809

This is to certify that **Mr. DARSHAN.N.S. Reg. No. 20NCIC809** has joined in our organization on 9/10/2022 and he will be working as internship trainee in our **SWEMED Biomedicals Pvt. Ltd.** for the period of 45 days.

Thanking You

With Regards

For SWEMED Biomedicals Pvt. Ltd.

For SWEMED BIOMEDICALS PVT. LTD

*Kumar*

Authorised signatory

HR Manager

*D. Sush*  
PRINCIPAL  
The National College  
Jayanagar, Bangalore-70.





**TO WHOMSOEVER IT MAY CONCERN**

This is to certify that Mr. Darshan N.S, bearing Reg.No. 20NCJC809 of VI Semester B.Com student, The National College, Autonomous, Jayanagar, Bangalore has successfully completed the project work for the period of 6 weeks, From 15/05/2023 to 17/06/2023 under the guidance of (JULIE GONSALVAS, MARKETING HEAD) at our organisation towards the fulfilment of award of "Bachelor of Commerce" during the year 2022-23.

**The title of his project work was Impact of branding on consumer purchasing behavior with reliance trends**

During the period of his project with us he has exhibited punctuality and diligence. We wish his every success in life.

Thank you,

For,  
Reliance Trends

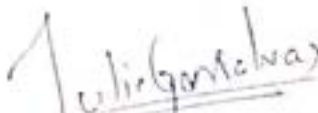
  
RELiance RETAIL LIMITED  
Bhartiya City Centre, Thanisandra,  
Bangalore, Karnataka - 560 077

  
PRINCIPAL  
The National College  
Jayanagar, Bangalore-70.







**Aurz Pharmaceutical Pvt. Ltd.**  
.....*Promise for a Healthy Growth*

CIN-U24231KA2007PTC044290

GST No : 29AAGCA6157R1ZV

Corporate Office :  
No. 85, Sri Shesha Jayamahala  
Top Floor, H Cross, Ideal Homes Township  
2nd Stage, Rajarajeshwari Nagar  
Bangalore - 560 098  
Mob. : +91 9008988121 Ph : 080 29743655  
E-mail : aurzpharmaceutical@gmail.com

## INTERNSHIP COMPLETION CERTIFICATE

Date: 20-11-2022

**Sub: Internship Completion Certificate Letter – Chethan S – Reg. No. 20NCJC808**

This is to certify that Mr. Chethan S, Reg. No. 20NCJC808, B.Com Final Year Student of The National College, Autonomous, Jayanagar, Bangalore has successfully completed internship of six weeks under the guidance of Malleth K at this Organization, towards the fulfillment of the award of "Bachelor of Commerce" during the year 2022-23.

During the period of his internship he has exhibited punctuality and diligence. We wish his every success in life.

With Regards,

Aurz Pharmaceutical Pvt., Ltd.,

Authorised Signatory



Date : 28-02-2023

Place : Bangalore

PRINCIPAL  
The National College  
Jayanagar, Bangalore-70.





**Aurz Pharmaceutical Pvt Ltd.**  
..... Promise for a Healthy Growth

Corporate office: No.85, Sri  
Shesha Jayamahal, Top Floor,  
H Cross, Ideal Homes, 2nd  
stage Rajarajeshwari nagar,  
Bangalore - 560098

## COMPLETION LETTER

This is to certify that Mr. **CHETHAN S** bearing Reg. No. **20NCJC808** of VI Semester B.Com student, The National College, Autonomous Jayanagar, Bangalore has successfully completed the project work for the period of 06 weeks April 25<sup>th</sup> to May 31<sup>st</sup> under the guidance **MALLESH K (ACCOUNTANT)** at our organisation towards the fulfilment of award of "Bachelor of Commerce" during the year 2023.

The title of his project work was **Brand Awareness** in Aurz Pharmaceutical Pvt Ltd Company.

During the period of his project with us he has exhibited punctuality and diligence. We wish him every success in life.

Thanking you.

AURZ PHARMACEUTICAL PRIVATE LIMITED COMPANY ,



*[Signature]*  
PRINCIPAL  
The National College  
Jayanagar, Bangalore-70.



Authorised signatory with company seal



ಬೆಂಗಳೂರು ನಗರ, ಬೆಂಗಳೂರು ಗ್ರಾಮಾಂತರ ಹಾಗೂ ರಾಮನಗರ  
ಜಿಲ್ಲಾ ಸಹಕಾರ ಹಾಲು ಉತ್ಪಾದಕರ ಸಂಘಗಳ ಒಕ್ಕೂಟ ನಿಯಮಿತ, ಬೆಂಗಳೂರು-29  
Bengaluru Urban, Bengaluru Rural & Ramanagara  
District Co-operative Milk Producers' Societies Union Ltd., Bengaluru-29



2011-2014  
CERTIFIED DAIRY



No.Bamul/Admn-10/cert/N-38(vol I)/2022-23

Date:08.12.2022

## CERTIFICATE

This is to certify that **Ms.Chandanashree.G(Reg No.20NCJc807)** The National College B.Com., part of Curriculum has undertaken Project entitled as **“Working Capital Management”** at Bengaluru Urban, Bengaluru Rural and Ramanagara District Co-operative milk producer's Societies Union Ltd., during 10.10.2022 to 23.11.2022

**General Manager(Admn)**  
**Bengaluru Co-Op Milk Union Ltd.,**

**PRINCIPAL**  
**The National College**  
**Jayanagar, Bangalore-70.**





## INTERNSHIP COMPLETION CERTIFICATE

This is to certify that Mr.Chandan V , Register No.20NCJC806, B.com Final Year student of The National College, Autonomous, Jayanagar, Bangalore has Successfully Completed Internship of 18 days Under the Guidance of At Tanishq Caratlane Jayanagar, Towards the fulfillment of the award of 'Bachelor of Commerce' during the year of 2022 - 23.

During the period of his internship he exhibited punctuality and diligence. We wish his every success in life.

Date :02/11/2022

Place:Bangalore



Hr-Executive

Tanishq Jayanagar

For SRSV AGRO COMPANY



PRINCIPAL  
The National College  
Jayanagar, Bangalore-70.



Partner

## PROJECT COMPLETION LETTER

DATE:

### TO WHOMSOEVER IT MAY CONCERN

This is to certify that Mr./Ms. CHANDAN.V bearing Reg. No.20NCJC806 of VI Semester B.Com student, The National College, Autonomous, Jayanagar, Bangalore has successfully completed the project work for the period of 06 weeks on 22 MAY 2023 under the guidance of KIRTI SHARMA Human resources paytm at our organisation towards the fulfilment of award of "Bachelor of Commerce" during the year 2022-23.

The title of his/her project work was "STUDY ON RETAILERS PERCEPTION OVER PAYTM TECHNOLOGY" .

During the period of his/her project with us he has exhibited punctuality and diligence. We wish him every success in life.

Thanking you.

For, PAYTM

### One97 Communication

533, 22nd A Main Rd, 2nd floor Agara Village,  
1st Sector, HSR Layout, Bengaluru,  
Karnataka 560102

  
Authorised signatory

  
PRINCIPAL  
The National College  
Jayanagar, Bangalore-70.



Date: 03<sup>rd</sup> November 2022.

TO WHOM SO EVER IT MAY CONCERN

Dear Sir/Madam,

This is to certify that Ms. Bhavana G M (Reg No: 20NCJC805) from National College Jayanagar Bangalore - 560070 has completed the internship in our organisation in Human Resource department from "20<sup>th</sup> Sept 2022 to 03<sup>rd</sup> November 2022."

During his Project work stay in the organisation, her character was found good.

We wish Mr. Bhavana G M all the best for his future Endeavour.

For METRO Cash and Carry India Pvt Ltd



HR Department-DC11

Authorised signature

  
PRINCIPAL  
The National College  
Jayanagar, Bangalore-70.



**METRO**

Cash & Carry India

YOUR SUCCESS IS OUR BUSINESS



## TAX CONSULTANT

### TO WHOM SO EVER IT MAY CONCERN

This is to certify that Ms. Anusha. N bearing Reg. No. 20NCJC803 of VI Semester B.Com student, The National College, Autonomous, Jayanagar, Bangalore has successfully completed the project work for the period of 4 weeks, From 20/05/2023 to 12/06/2023 under the guidance of Nagesh at our organisation towards the fulfilment of award of "Bachelor of Commerce" during the year 2022-23.

The title of her project work was **GST & Income Tax Filling.**

During the period of her project with us she has exhibited punctually and diligence. We wish her every success in life.

Thanking you.

For.

GST & Income Tax Filling

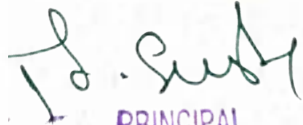

  
PRINCIPAL  
The National College  
Jayanagar, Bangalore-70.



**GST & Income Tax Filling**

No.2 1<sup>st</sup> Floor, BMTC Bus Stand, in GST Office, HAL old Airport RD, Domlur, Bengaluru,  
Karnataka 560071

## TAX CONSULTANT

### TO WHOM SO EVER IT MAY CONCERN

This is to certify that Ms. Anusha. N bearing Reg. No. 20NCJC803 of VI Semester B.Com student, The National College, Autonomous, Jayanagar, Bangalore has successfully completed the project work for the period of 4 weeks, From 20/05/2023 to 12/06/2023 under the guidance of Nagesh at our organisation towards the fulfilment of award of "Bachelor of Commerce" during the year 2022-23.

The title of her project work was **GST & Income Tax Filling.**

During the period of her project with us she has exhibited punctually and diligence. We wish her every success in life.

Thanking you.

For.

GST & Income Tax Filling



  
PRINCIPAL  
The National College  
Jayanagar, Bangalore-70.



**GST & Income Tax Filling**

No.2 1<sup>st</sup> Floor, BMTC Bus Stand, in GST Office, HAL old Airport RD, Domlur, Bengaluru,  
Karnataka 560071

## INTERNSHIP COMPLETION CERTIFICATE

This is to certify that Mr.ABHISHEK VR, Reg No.20NCJC802, B.Com Final Year student of The National College, Autonomous, Jayanagar, Bangalore has successfully completed internship of 16 days under the guidance of Mr Ashok Savanth (Store Manager) at this organization (*Tanishq Bannerghatta Road*), towards the fulfillment of the award of '*Bachelor of Commerce*' during the year 2022-23.

During the period of his/her internship he/she has exhibited punctuality and diligence. We wish his/her every success in life.

*Ashok Savanth*



(Authorized signature with seal)

Date:

Place:

*D. Sush*

PRINCIPAL  
The National College  
Jayanagar, Bangalore-70.





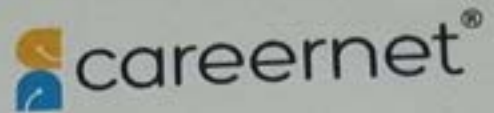

19<sup>th</sup> Jul 2023

**TO WHOMSOEVER IT MAY CONCERN**

This is to certify that **Mr. Abhishek V R**, a student of **The National College Autonomous, Jayanagar, Bangalore**. Pursuing **B. COM** has successfully completed the project with **Careernet Technologies Pvt. Ltd.**, for academic purposes.

**Below are the details of the project:**

Project Title: **Talent Branding**

Project Duration: **22<sup>nd</sup> May 2023 to 13<sup>th</sup> Jun 2023**

We appreciate the efforts made by him for the project and extend our best wishes for his future endeavors.

For **Careernet Technologies Pvt. Ltd.**

Digitally signed by  
**KAVITHA S**  
Date: 2023.07.20 17:01:37  
+05'30'

**Kavitha S**  
Vice President -HR

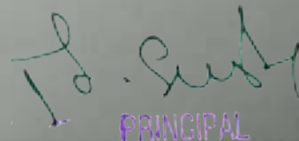
  
PRINCIPAL

The National College  
Jayanagar, Bangalore-70

Corporate Office: Careernet Technologies Pvt. Ltd.,  
Kanyamma Agrahara Road, Devanabeesanahalli,  
Outer Ring Road, Bellandur Post, Bengaluru 560103

www.careernet.in

CONFIDENTIAL

CIN :U51909KA2010PTC055001

## INTERNSHIP COMPLETION CERTIFICATE

This is to Certify that **Mr. ABHISHEK K. Reg. No. 20NCJC801**, B.Com Final Year student of the National College, Autonomous, Jayanagara, Bengaluru has successfully completed **internship of 45 days** under the guidance of Mr. Chethan Kumar B (Accounts Manager) at this organization (Newwill Biotech Pvt Ltd), towards the fulfillment of the award of 'Bachelor of Commerce' during the year 2022-23.

During the period of his internship he has exhibited punctuality and diligence. We wish his every success in life.

For Newwill Biotech Pvt Ltd

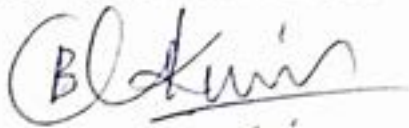

(Authorized Signature with seal)

Date : 07.11.2022



PRINCIPAL

The National College  
Jayanagar, Bangalore-70.

Place : Bengaluru



CIN :U51909KA2010PTC055001

## INTERNSHIP COMPLETION CERTIFICATE

This is to Certify that **Mr. ABHISHEK K. Reg. No. 20NCJC801**, B.Com Final Year student of the National College, Autonomous, Jayanagara, Bengaluru has successfully completed **internship of 45 days** under the guidance of Mr. Chethan Kumar B (Accounts Manager) at this organization (Newwill Biotech Pvt Ltd), towards the fulfillment of the award of 'Bachelor of Commerce' during the year 2022-23.

During the period of his internship he has exhibited punctuality and diligence. We wish his every success in life.

For Newwill Biotech Pvt Ltd

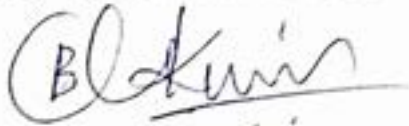

(Authorized Signature with seal)

Date : 07.11.2022

Place : Bengaluru



PRINCIPAL  
The National College  
Jayanagar, Bangalore-70.







# Briskon

TRANSFORM WITH AGILITY

NO.38/5, Berlie Street,  
Langford Town, Hosur Road,  
Bengaluru - 560078

Ref:

Date: 11/06/2023

**PROJECT COMPLETION LETTER**  
**TO WHOMSOEVER IT MAY CONCERN**

This is to certify that Mr. Abhishek.K bearing Reg. No. 20NCJC801 of VI Semester B.Com student, The National College, Autonomous, Jayanagar, Bangalore has successfully completed the project work for the period of 04 weeks 10/05/2023 to 10/06/2023 under the guidance of Mr. Hemanth (Accounts Manager) at our organization towards the fulfilment of award of "Bachelor of Commerce" during the year 2021-22.

The title of his project work was: **A Study on Revenue recognition in Briskon Technologies Pvt Ltd.**

During the period of his project with us he has exhibited punctuality and diligence. We wish him every success in life.

Thanking you.

**Briskon Technologies Pvt Ltd.**

For Briskon Technologies Pvt Ltd

  
Authorised Signatory

Authorised signatory

  
PRINCIPAL  
The National College  
Jayanagar, Bangalore-70.



## Experience Letter

Date: 10/08/2023

### To Whom It May Concern

This letter is to certify that Tejas V has worked as Data Science Intern in various proof-of-concepts and client projects during the internship program with Rubixe from 29/4/2023 to PRESENT.

During this internship period, we found Tejas V has hardworking, diligent, and delivered the tasks assigned in time.

*Deepak*

Deepak ( Aug 10 , 2023 16:58 GMT+5.5)

Sincerely,

Deepak Dongere,

Director

*D. Suresh*  
PRINCIPAL  
The National College  
Jayanagar, Bangalore-70.



## Experience Letter

Date: 10/08/2023

### To Whom It May Concern

This letter is to certify that Tejas V has worked as Data Science Intern in various proof-of-concepts and client projects during the internship program with Rubixe from 29/4/2023 to PRESENT.

During this internship period, we found Tejas V has hardworking, diligent, and delivered the tasks assigned in time.

*Deepak*

Deepak ( Aug 10 , 2023 16:58 GMT+5.5)

Sincerely,

Deepak Dongere,

Director

*D. Suresh*  
PRINCIPAL  
The National College  
Jayanagar, Bangalore-70.





## Experience Letter

Date: 10/08/2023

### To Whom It May Concern

This letter is to certify that Tejas V has worked as Data Science Intern in various proof-of-concepts and client projects during the internship program with Rubixe from 29/4/2023 to PRESENT.

During this internship period, we found Tejas V has hardworking, diligent, and delivered the tasks assigned in time.

Deepak

Deepak ( Aug 10 , 2023 16:58 GMT+5.5)

Sincerely,

Deepak Dongere,

Director

  
PRINCIPAL  
The National College  
Jayanagar, Bangalore-70.





## Certificate of Internship

This is to certify

**Suraj MJ**

---

of **National College**

Has successfully started an internship of 3 months on project **Maven**  
from 3<sup>rd</sup> April 2023 with **Datazymes Analytics Private Limited**



Authorized Signatory  
**Amith Mohandas**

  
PRINCIPAL  
**The National College**  
Jayanagar, Bangalore-70.





## Certificate of Internship

This is to certify

**Suraj MJ**

---

of **National College**

Has successfully started an internship of 3 months on project **Maven**  
from 3<sup>rd</sup> April 2023 with **Datazymes Analytics Private Limited**



Authorized Signatory  
**Amith Mohandas**

  
PRINCIPAL  
**The National College**  
Jayanagar, Bangalore-70.







## Certificate of Internship

This is to certify

**Suraj MJ**

---

of **National College**

Has successfully started an internship of 3 months on project **Maven**  
from 3<sup>rd</sup> April 2023 with **Datazymes Analytics Private Limited**



Authorized Signatory  
**Amith Mohandas**

  
PRINCIPAL  
**The National College**  
Jayanagar, Bangalore-70.



## Internship Certificate

This is to certify that SAI KIRAN . V a student of THE  
NATIONAL COLLEGE , JAYANAGAR has completed 3 months/weeks of Internship  
From 15-05-2023 To 15-08-2023 in MACHINE LEARNING Domain.

We wish you all the best in your future endeavors.

Date : 15-08-2023

  
PRINCIPAL

The National College  
TechnoFly Solutions, Vijayanagar, Bangalore - 40.  
Mob.: 9863476586, 9741150102 | www.technofly.in

For TechnoFly Solutions



## Internship Certificate

This is to certify that SAI KIRAN . V a student of THE  
NATIONAL COLLEGE , JAYANAGAR has completed 3 months/weeks of Internship  
From 15-05-2023 To 15-08-2023 in MACHINE LEARNING Domain.

We wish you all the best in your future endeavors.

Date : 15-08-2023

  
PRINCIPAL

The National College,  
TechnoFly Solutions, Vijayanagar, Bangalore - 40.  
Mob.: 9863476586, 9741150102 | www.technofly.in

For TechnoFly Solutions





## Internship Certificate

This is to certify that SAI KIRAN . V a student of THE  
NATIONAL COLLEGE , JAYANAGAR has completed 3 months/weeks of Internship  
From 15-05-2023 To 15-08-2023 in MACHINE LEARNING Domain.

We wish you all the best in your future endeavors.

Date : 15-08-2023

  
PRINCIPAL

The National College,  
Bangalore - 40.  
Mob.: 9863476586, 9741150102 | www.technofly.in

For TechnoFly Solutions



# TechnoFly Solutions

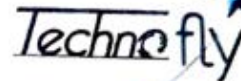

TechnoFly

## Internship Certificate

This is to certify that REHAN KHAN .A a student of THE  
NATIONAL COLLEGE , JAYANAGAR has completed 3 months/weeks of Internship  
From 20-5-2023 To 20-8-2023 in MACHINE LEARNING Domain.

We wish you all the best in your future endeavors.

Date : **15-08-2023**

For TechnoFly Solutions

  
PRINCIPAL  
TechnoFly Solutions, Vijayanagar, Bangalore - 40.  
Mob.: 968276586, 971150102 | www.technofly.in  
The National College  
Jayanagar, Bangalore-70.



# TechnoFly Solutions

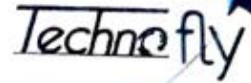

TechnoFly

## Internship Certificate

This is to certify that REHAN KHAN .A a student of THE  
NATIONAL COLLEGE , JAYANAGAR has completed 3 months/weeks of Internship  
From 20-5-2023 To 20-8-2023 in MACHINE LEARNING Domain.

We wish you all the best in your future endeavors.

Date : **15-08-2023**

For TechnoFly Solutions

  
PRINCIPAL  
TechnoFly Solutions, Vijayanagar, Bangalore - 40.  
Mob.: 968276586, 971150102 | www.technofly.in  
The National College  
Jayanagar, Bangalore-70.







# THE NATIONAL COLLEGE

Autonomous

Jaynagar, Bangalore-560070

ಭವ್ಯಾಹಿ ಪರಮಾ ಗತಿಃ ||

## CERTIFICATE

This is to certify that the project report on "RESEARCH OF A COMPANY" titled "WALMATR" is bonafied record of Work done by ANAND. V (20NCJB602) of THE NATIONAL COLLEGE, Jaynagar, Banglore, in partial fulfillment of the Requirements of IV Semester BCA [DS], TECHNICAL ENGLISH during the year 2021-2022.

STUDENT SIGNATURE

Anand.V

PROJECT GUIDE

Rajni

HEAD OF DEPARTMENT

  
PRINCIPAL  
The National College  
Jaynagar, Bangalore-70.  
Head, Dept of English  
The National Degree College  
(Autonomous, 7th Block,  
Jaynagar, Bangalore - 70.

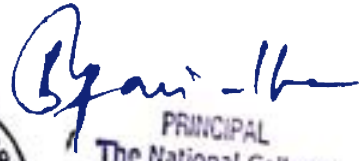

  
PRINCIPAL  
The National College  
Jaynagar, Bangalore-70

AMAZON project reported submitted in partial fulfilment of the requirement of IV Semester BCA [DATA SCIENCE], TECHNICAL ENGLISH, THE NATIONAL COLLEGE, Jayanagar, Bangalore -560070



**THE NATIONAL COLLEGE**  
Autonomous  
Jayanagar, Bangalore -560070

**CERTIFICATE**

This is to certify that the project report on "RESEARCH OF A COMPANY" titled "AMAZON" is a bonafide record of work done by ANANTA RAJA (20NCJB603) of THE NATIONAL COLLEGE, Jayanagar, Bangalore, in partial fulfilment of the requirements of IV Semester [DATA SCIENCE], TECHNICAL ENGLISH during the year 2021-2022

STUDENT SIGNATURE

*Ananta Raja*

*D. Sudha*  
PRINCIPAL  
The National College  
Jayanagar, Bangalore-70.

PROJECT GUIDE

*Chitra*

HEAD OF DEPARTMENT

*Chitra*  
Head, Dept of  
The National College  
Autonomous  
Jayanagar, Bangalore



*Chitra*  
PRINCIPAL  
The National College  
Jayanagar, Bangalore-70.



**THE NATIONAL COLLEGE**  
**Autonomous**  
**Jayanagar, Bangalore -560070**

**CERTIFICATE**

This is to certify that the project report on "RESEARCH OF A COMPANY" titled "INFOSYS" is a bonafide record of work done by ANIL KUMAR V S (20NCJB604) of THE NATIONAL COLLEGE, Jayanagar, Bangalore, in partial fulfilment of the requirements of IV Semester [DATA SCIENCE], TECHNICAL ENGLISH during the year 2021-2022

*Anil kumar*  
**STUDENT SIGNATURE**

*Chitab*  
**PROJECT GUIDE**

*D. Sudh*  
**PRINCIPAL**  
**HEAD OF DEPARTMENT**  
The National College  
Jayanagar, Bangalore-70.  
**Head, Dept of English**  
The National Degree  
Autonomous 7th Cross,  
Jayanagar, Bangalore - 70.



*Pravin - 16*  
**PRINCIPAL**  
The National College  
Jayanagar, Bangalore





|| ಪ್ರವೃತ್ತಿ ವರಮಾ ನಮಃ ||

# THE NATIONAL COLLEGE

Autonomous

Jayanagar, Bangalore-560070

## CERTIFICATE

This is to certify that the project report on "RESEARCH OF A COMPANY" titled "WELLS FARGO" is a bonafide record of work done by ASHITH NAIDU(20NCJB605) of THE NATIONAL COLLEGE, Jayanagar, Bangalore, in partial fulfilment of the requirements of IV Semester BCA [Data science], TECHNICAL ENGLISH during the year 2022.

HEAD OF THE DEPARTMENT  
GUIDE

*Ch. G. Prasad*  
PROJECT GUIDE

DATE OF EXAMINATION:

STUDENT SIGNATURE:

*Ashith Naidu*  
(ASHITH NAIDU)

*Ch. G. Prasad*  
Head, Dept of English  
The National College  
(Autonomous)  
Jayanagar, Bangalore-70



*Ch. G. Prasad*  
PRINCIPAL  
The National College  
Jayanagar, Bangalore-70



**The National College**  
(Autonomous)  
Jayanagar, Bengaluru -560070

**CERTIFICATE**

It is to certify that the project report on "**Research of A Company**" titled "**RELIANCE INDUSTRIES**" is a Bona fide record of work done by **CHANDAN B REDDY (20NCJB606)** of The National College, Jayanagar, Bangalore, in partial fulfilment of the requirements of IV semester BCA (DS). **Technical English** during the year 2021-2022.

Student Signature:

Project Guide:

*D. Sudha*  
PRINCIPAL  
The National College  
Jayanagar, Bangalore-70.

Head of the Department:

*By...*  
The National College  
Jayanagar, Bangalore-70.

Head, Dept of English  
The National Degree College  
Autonomous, 7th Street,  
Jayanagar, Bangalore - 70





# THE NATIONAL COLLEGE

**AUTONOMOUS**

**Jayanagar, Bangalore-560070**

## CERTIFICATE

This is to certify that the project report on "RESEARCH OF A COMPANY" titled "IBM" is a bonafide record of work done by **CHANDANA.S (20NCJB607)** of THE NATIONAL COLLEGE, Jayanagar, Bangalore, in partial fulfillment of the requirements of **IV Semester BCA[DATA SCIENCE], TECHNICAL ENGLISH** during the year 2020 – 2021.

Chandana.S  
**STUDENT SIGNATURE:**

Chandana S (20NCJB607)

*Chandana S*  
*Prudha*

*Prudha*

PRINCIPAL  
The National College  
Jayanagar, Bangalore-70.

*Prudha*  
Head, Dept of English  
The National College  
(Autonomous)  
Jayanagar, Bangalore-70.





## DECLARATION

I hereby declare that the project report on RESEARCH OF A COMPANY titled "DTDC EXPRESS LIMITED" which I am submitting for the partial fulfilment of B.C.A (DS), TECHNICAL ENGLISH course at The National College, Jayanagar, Bengaluru-70, is the original work carried out by me under the guidance of prof. CHITRA. V , prof. RAJANI RAVEENRA and prof. NANDINI Department of English.

I further declare that this project has not been submitted earlier.

Place:

STUDENT NAME: DEEKSHA N

Date: 11/08/2022

REGD NO: 20NCJB608

*Chitra V*  
Guide

## CERTIFICATE

CERTIFICATE This is to certify that the project report on "RESEARCH OF A COMPANY" titled "DTDC EXPRESS LIMITED" is a bonafide record of work done by DEEKSHA. N(20NCJB608) of THE NATIONAL COLLEGE, Jayanagar, Bangalore, in partial fulfilment of the requirements of IV Semester BCA [DS], TECHNICAL ENGLISH during the year 2021-2022.



*Rajani Raveenra*  
PRINCIPAL  
The National College  
Jayanagar, Bangalore-70



ಶಿಕ್ಷಣವೇ ಸಮಾನತೆಗೆ ಕಿರುಕಿರು

**THE NATIONAL COLLEGE**

**Autonomous**

**Jayanagar, Bangalore -560070**

**CERTIFICATE**

This is to certify that the project report on "RESEARCH OF A COMPANY" titled "NYKAA" is a bonafide record of work done by GIRISH E (20NCJB609) of THE NATIONAL COLLEGE, Jayanagar, Bangalore, in partial fulfilment of the requirements of IV Semester [DATA SCIENCE], TECHNICAL ENGLISH during the year 2021-2022

**STUDENT SIGNATURE**

Girish. E

*[Handwritten Signature]*  
**PROJECT GUIDE**

*[Handwritten Signature]*  
**PRINCIPAL**  
The National College  
Jayanagar, Bangalore-70.  
**HEAD OF DEPARTMENT**  
Head. Dept of English  
The National Degree College  
(Autonomous), 7th Block,  
Jayanagar, Bangalore - 70.



*[Handwritten Signature]*  
**PRINCIPAL**  
The National College  
Jayanagar, Bangalore-70



ಶ್ರೀ ಶಿವಕಾಂತ್ ಮಹಾವಿದ್ಯಾಲಯ

**THE NATIONAL COLLEGE**

**Autonomous**

**Jayanagar, Bangalore -560070**

**CERTIFICATE**

This is to certify that the project report on "RESEARCH OF A COMPANY" titled "ONEPLUS" is a Bonafide record of work done by MAHESH BABU L C (20NCJB611) of THE NATIONAL COLLEGE, Jayanagar, Bangalore, in partial fulfilment of the requirements of IV Semester [DATA SCIENCE], TECHNICAL ENGLISH during the year 2021-2022

*MAHESH BABU L C*

**STUDENT SIGNATURE**

*[Handwritten Signature]*

**PROJECT GUIDE**

*[Handwritten Signature]*

**HEAD OF DEPARTMENT**

**PRINCIPAL**

**The National College**

**Head, Department of English**  
**The National Degree College**  
**(Autonomous) Jayanagar,**  
**Bangalore - 70.**

*[Handwritten Signature]*

**PRINCIPAL**

**The National College**  
**Jayanagar, Bangalore-70**







ಶಿಕ್ಷಣೇ ವಿದ್ಯಾ ನಿದಾ

# THE NATIONAL COLLEGE

Autonomous

Jayanagar, Bangalore-560070

## CERTIFICATE

This is to certify that the project report entitled " CASE STUDY ON MICROSOFT COMPANY" is a Bonafide record of work done by MEGHANA M(20NCJB612) of THE NATIONAL COLLEGE, Jayanagar, Bangalore, in partial fulfilment of the requirements of IV Semester BCA (DATA SCIENCE), TECHNICAL ENGLISH during the year 2021-2022.

*Meghana M*  
STUDENT SIGNATURE:

Meghana M(20NCJB612)

DATE OF EXAMINATION:

HEAD OF THE DEPARTMENT

*D. Sush*  
PRINCIPAL  
The National College  
Jayanagar, Bangalore-70.  
*C. V. ...*  
Head, Dept of English  
The National College  
Jayanagar, Bangalore-70.



*Chali*  
PROJECT GUIDE

*Byani - 16*  
PRINCIPAL  
The National College  
Jayanagar, Bangalore-70.



• ಶಿಲ್ಪಕಲಾ - ವಿಜ್ಞಾನ - ಸಾಹಿತ್ಯ •

# THE NATIONAL COLLEGE

**Autonomous**

**Jayanagar, Bangalore -560070**

## CERTIFICATE

This is to certify that the project report on **“RESEARCH OF A COMPANY”** titled **“JIO”** is a bonafide record of work done by **NITHISH G (20NCJB613)** of **THE NATIONAL COLLEGE,** Jayanagar, Bangalore, in partial fulfilment of the requirements of **IV Semester [DATA SCIENCE], TECHNICAL ENGLISH** during the year 2021-2022

**STUDENT SIGNATURE**

*Nithish G*

*Chitra*

**PROJECT GUIDE**

**HEAD OF DEPARTMENT**

*[Signature]*  
**PRINCIPAL**  
The National College  
Jayanagar, Bangalore-70.  
**Head, Dept of English**  
The National Degree College  
(Autonomous) 7th Block,  
Jayanagar, Bangalore - 70.



*[Signature]*

**PRINCIPAL**  
The National College  
Jayanagar, Bangalore-70.



# The National College

Autonomous

Jayanagar, Bengaluru -560070

|| ಶ್ರದ್ಧಾಪುಷ್ಪ ಪರಮಾ ಗತಿಃ ||

## CERTIFICATE

This is to certify that the project report on "**Research of A Company**" titled "**Tata Motors**" is a bonafide record of work done by Rohit BC (20NCJB614) of The National College, Jayanagar, Bangalore, in partial fulfilment of the requirements of IV Semester BCA (DS). **Technical English** during the year 2021-2022.

Student Signature:

Rohit

Project Guide:

*[Handwritten Signature]*

PRINCIPAL

The National College  
Jayanagar, Bangalore-70.

Head of the Department:

*[Handwritten Signature]*  
Head, Dept of English  
The National Degree College  
(Autonomous) 7th Block,  
Jayanagar, Bangalore - 70.

1 | Page



*[Handwritten Signature]*  
PRINCIPAL  
The National College  
Jayanagar, Bangalore-70.





॥ ज्ञानं विद्यायां शान्तिः ॥

# THE NATIONAL COLLEGE

Autonomous

Jayanagar, Bangalore-560070

## CERTIFICATE

This is to certify that the project report entitled "CASE STUDY ON APPLE INC." is a bonafide record of work done by SHASHANK A(20NCJB615) of THE NATIONAL COLLEGE, Jayanagar, Bangalore, in partial fulfilment of the requirements of IV Semester BCA (Data science), TECHNICAL ENGLISH during the year 2021-2022.

STUDENT SIGNATURE

*Shashank A.*

Shashank A(20NCJB615)

Date of Examination: *Sush*

*Sush*  
PRINCIPAL  
The National College  
Jayanagar, Bangalore-70

*Rajni*

PROJECT GUIDE

HEAD OF THE DEPARTMENT

*CVK*

Head, Dept of English  
The National Degree College  
(Autonomous) 7th Block, Jayanagar, Bangalore - 70. Page 3





**THE NATIONAL COLLEGE**  
**Autonomous**  
**Jayanagar, Bangalore -560070**

**CERTIFICATE**

This is to certify that the project report on “RESEARCH OF A COMPANY” titled “FLIPKART” is a bonafide record of work done by **Vinod. V (20NCJB616)** of **THE NATIONAL COLLEGE, Jayanagar, Bangalore**, in partial fulfilment of the requirements of **IV Semester [DATA SCIENCE], TECHNICAL ENGLISH** during the year 2021-2022

*Vinod.V*  
**STUDENT SIGNATURE**

*Chell*  
**PROJECT GUIDE**

**HEAD OF DEPARTMENT**

*[Signature]*  
**PRINCIPAL**  
The National College  
Jayanagar, Bangalore-70.  
Head, Dept. of English  
The National Degree College  
(Autonomous) 7th Block,  
Jayanagar, Bangalore - 70.

*[Signature]*  
**PRINCIPAL**  
The National College  
Jayanagar, Bangalore-70





# THE NATIONAL COLLEGE

Autonomous

Jayanagar, Bangalore-560070

|| ಶ್ರದ್ಧಾಹಿ ಪರಮಾ ಗತಿಃ ||

## CERTIFICATE

This is to certify that the project report entitled " CASE STUDY ON NESTLE COMPANY" is a *Bonafide* record of work done by VISHAL SINGH A (20NCJB617) of THE NATIONAL COLLEGE, Jayanagar, Bangalore, in partial fulfilment of the requirements of IV Semester BCA [DATA SCIENCE], TECHNICAL ENGLISH during the year 2021-2022.

STUDENT SIGNATURE:

VISHAL SINGH A (20NCJB617)

DATE OF EXAMINATION:

HEAD OF THE DEPARTMENT

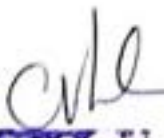
  
Head, Dept of English  
The National Degree College  
(Autonomous), 7th Block,  
Jayanagar, Bangalore-70.

  
PRINCIPAL  
The National College  
Jayanagar, Bangalore-70.

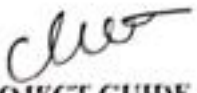

PROJECT GUIDE

  
PRINCIPAL  
The National College  
Jayanagar, Bangalore-70.





॥ ಶ್ರದ್ಧಾಽ ಪಠಮಾ ಗತಿಃ ॥

# The National College

Autonomous

Jayanagar, Bengaluru -560070

## CERTIFICATE

This is to certify that the project report on "**Research of A Company**" titled "**ACCENTURE**" is a bonafide record of work done by Smrithi Shaji (20NCJB618) of The National College, Jayanagar, Bangalore, in partial fulfilment of the requirements of IV Semester BCA (DS). **Technical English** during the year 2021-2022.

Student Signature:

*Smrithi*

Project Guide:

*Chel*

Head of the Department:

*D. Sudh*  
PRINCIPAL  
The National College  
Jayanagar, Bangalore-70.

*Chel*

Head, Dept of English  
The National Degree College  
(Autonomous) 7th Block,  
Jayanagar, Bangalore - 70.



*Byani - the*  
PRINCIPAL  
The National College  
Jayanagar, Bangalore-70.



॥ वाचं धेनुमुपासीत ॥

# THE NATIONAL COLLEGE

AUTONOMOUS

Jayanagar, Bengaluru – 560070

## CERTIFICATE

This is to certify that the project report on “RESEARCH OF A COMPANY” titled “TATA GROUP” is a bonafide record of work done by **SRINIDHI N A (20NCJB619)** of **THE NATIONAL COLLEGE**, Jayanagar, Bangalore, in partial fulfilment of the requirements of **IV Semester [DATA SCIENCE], TECHNICAL ENGLISH** during the year 2021-22

**STUDENT SIGNATURE**

*Srinidhi . n . a*

**PROJECT GUIDE**

*Chand*

*D. Sudh*

**HEAD OF DEPARTMENT**

**PRINCIPAL**  
The National College  
Jayanagar, Bangalore-70.

*Byani - I*

**PRINCIPAL**  
The National College  
Jayanagar, Bangalore-70.



*Chand*

**Head, Dept of English**  
The National Degree College  
(Autonomous), 7th Block  
Jayanagar, Bangalore - 70.



॥ ज्ञानं विद्यायां श्रेष्ठं ॥

# The National College

(Autonomous)

Jayanagar, Bengaluru -560070

## CERTIFICATE

This is to certify that the project report on "Research of A Company" titled " **Berkshire Hathaway** " is a bona fide record of work done by SUPREETH TS (20NCJB620) of The National College, Jayanagar, Bangalore, in partial fulfilment of the requirements of IV Semester BCA (DS). **Technical English** during the year 2021-2022.

Student Signature:

Supreeth T.S.

Project Guide:

Chitra

Head of the Department

*T.S. Sudha*  
PRINCIPAL  
The National College  
Jayanagar, Bangalore-70.

*Chitra*

*Pravin Kumar*  
PRINCIPAL  
The National College  
Jayanagar, Bangalore-70.

1 | P a g e

Head, Dept of English,  
The National Degree College  
(Autonomous) 7th Block  
Jayanagar







# THE NATIONAL COLLEGE

Autonomous

Jayanagar, Bangalore-560070

PROJECT REPORT  
ON  
RESEARCH OF A COMPANY  
TITLED  
"TATA"

Sanath Kumar(20NCJB621)

Under the guidance of  
Prof. Rajani Ravindra  
Prof. Chitra V  
Prof. Nandini Madhusudhan

  
PRINCIPAL  
The National College  
Jayanagar, Bangalore-70  
TATA GROUPS project report submitted in partial fulfillment of the requirement of  
IV Semester BCA [DS], TECHNICAL ENGLISH, THE NATIONAL  
COLLEGE, JAYANAGAR.



## THE NATIONAL COLLEGE

Autonomous

Jayanagar, Bangalore -560070

### CERTIFICATE

This is to certify that the project report on "RESEARCH OF A COMPANY" titled "DOMINO'S" is a bonafide record of work done by REHAN KHAN (20NCJB623) of THE NATIONAL COLLEGE, Jayanagar, Bangalore, in partial fulfilment of the requirements of IV Semester [DATA SCIENCE], TECHNICAL ENGLISH during the year 2021-2022

STUDENT SIGNATURE

  
PROJECT GUIDE

HEAD OF DEPARTMENT

  
PRINCIPAL  
The National College  
Jayanagar, Bangalore-70.

  
Head, Dept of English  
The National Degree College  
(Autonomous), 7th Block,  
Jayanagar, Bangalore - 70.



  
PRINCIPAL  
The National College  
Jayanagar, Bangalore-70.



|| ಪ್ರವೃತ್ತಿ ಪರಮಾ ಗತಿ: ||

**THE NATIONAL COLLEGE**  
Autonomous  
Jayanagar, Bangalore-560070

**CERTIFICATE**

This is to certify that the project report on “RESEARCH OF A COMPANY” titled “GENPACT” is a bonafide record of work done by SAI KIRAN V (20NCJB624) of THE NATIONAL COLLEGE, Jayanagar, Bangalore, in partial fulfilment of the requirements of IV Semester BCA [DATA SCIENCE], TECHNICAL ENGLISH during the year 2021-2022.

DATE OF EXAMINATION:

STUDENT SIGNATURE:

(SAI KIRAN V) 20NCJB624

**PROJECT GUIDE**

**HEAD OF THE DEPARTMENT**

Head, Dept of English  
The National Degree College  
(Autonomous) 7th Block  
Jayanagar, Bangalore - 70.

**DECLARATION**

PRINCIPAL  
The National College  
Jayanagar, Bangalore - 70.

PRINCIPAL  
The National College  
Jayanagar, Bangalore-70.







**THE NATIONAL COLLEGE**  
**Autonomous**  
**Jayanagar, Bangalore -560070**

**CERTIFICATE**

This is to certify that the project report on “RESEARCH OF A COMPANY” titled “STARBUCKS” is a bonafide record of work done by SURAJ M J (20NCJB625) of THE NATIONAL COLLEGE, Jayanagar, Bangalore, in partial fulfilment of the requirements of IV Semester [DATA SCIENCE], TECHNICAL ENGLISH during the year 2021-2022

*Suraj M J*  
**STUDENT SIGNATURE**

*Chet*  
**PROJECT GUIDE**

*J. S. S. S.*  
**HEAD OF DEPARTMENT**  
PRINCIPAL  
The National College  
Jayanagar, Bangalore-70.

*Chet*  
**Head, Dept of English**  
The National Degree College  
(Autonomous) 7th Block,  
Jayanagar, Bangalore - 70.

*Pravin - 16*  
**PRINCIPAL**  
The National College  
Jayanagar, Bangalore-70





# THE NATIONAL COLLEGE

**AUTONOMOUS**

**JAYANAGAR, BANGALORE**

## CERTIFICATE

THIS IS TO CERTIFY THAT THE PROJECT REPORT ON "RESEARCH OF A COMPANY" TITLED "**CAPGEMINI**" IS A BONA FIDE RECORD OF WORK DONE BY TEJAS V[20NCJB626] OF THE NATIONAL COLLEGE, JAYANAGAR, BANGALORE, IN PARTIAL FULFILLMENT OF THE REQUIREMENTS OF IV SEMESTER BCA [DATA SCIENCE], **TECHNICAL ENGLISH** DURING THE YEAR 2021 - 2022.

HEAD OF THE DEPARTMENT

PROJECT GUIDE

DATE OF EXAMINATION

STUDENT SIGNATURE:

*[Handwritten Signature]*  
PRINCIPAL  
The National College  
Jayanagar, Bangalore-70.  
Head, Dept of English  
The National Degree College  
(Autonomous) 7th Block,  
Jayanagar, Bangalore - 70.

*[Handwritten Signature]*  
(TEJAS) 20NCJB626



*[Handwritten Signature]*  
PRINCIPAL  
The National College  
Jayanagar, Bangalore-70



|| ಪ್ರವೃತ್ತಿ ಪರಮಾ ಗತಿ: ||

# THE NATIONAL COLLEGE

Autonomous

Jayanagar, Bangalore -

560070

## CERTIFICATE

This is to certify that the project report entitled **CASE STUDY ON NIKE** is a bonafide record of work done by **GOKUL SUDARSHAN K V (20NCJB706)** of **THE NATIONAL COLLEGE, Jayanagar, Bangalore, in partial fulfilment of the requirements of IV Semester BCA [INTERNET OF THINGS], TECHNICAL ENGLISH** during the year **2021-2022**.

STUDENT SIGNATURE: *Gokul*

GOKUL SUDARSHAN K V (20NCJB706)

DATE OF EXAMINATION: *2.5.22*

PRINCIPAL

The National College  
Jayanagar, Bangalore-70.

*Chet*  
PROJECT GUIDE

*Chet*  
Head, Dept of English  
The National Degree College  
(Autonomous) 7th Block,  
Jayanagar, Bangalore - 70.

HEAD OF THE DEPARTMENT



*Chet*  
PRINCIPAL

The National College  
Jayanagar, Bangalore-70.





ಶಿಕ್ಷಣವೇ ಮನುಷ್ಯನ ಅಭಿವೃದ್ಧಿಯ ಮಾರ್ಗ

# THE NATIONAL COLLEGE

Autonomous

Jayanagar, Bangalore-560070

## CERTIFICATE

This is to certify that the project report entitled "CASE STUDY ON INFOSYS GROUPS." is a bonafide record of work done by AKSHATHA (20NCJB601) of THE NATIONAL COLLEGE, Jayanagar, Bangalore, in partial fulfilment of the requirements of IV Semester BCA (Data science), TECHNICAL ENGLISH during the year 2021-2022.

*Akshatha*

STUDENT SIGNATURE

*D. Sudha*

Akshatha (20NCJB601)  
Date of Examination

PRINCIPAL  
The National College  
Jayanagar, Bangalore-70

*[Signature]*

PROJECT GUIDE

*[Signature]*  
Head of Dept of English  
The National Degree College  
Autonomous, 7th Block  
Jayanagar, Bangalore - 70

HEAD OF THE DEPARTMENT

*[Signature]*

PRINCIPAL  
The National College  
Jayanagar, Bangalore-70 Page 3





ಶಿಕ್ಷಣದ ಮೂಲಕ ನಡೆಸಿ

**THE NATIONAL COLLEGE**

**Autonomous**

**Jayanagar, Bangalore - 560070**

**CERTIFICATE**

This is to certify that the project report entitled CASE STUDY ON Alibaba is a bonafide record of work done by KISHAN HEBBAR MN (20NCJB707) of THE NATIONAL COLLEGE, Jayanagar, Bangalore, in partial fulfilment of the requirements of IV Semester BCA [INTERNET OF THINGS], TECHNICAL ENGLISH during the year 2021-2022.

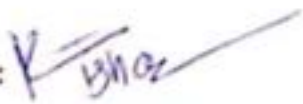
STUDENT SIGNATURE: 

KISHAN HEBBAR MN (20NCJB707)

DATE OF EXAMINATION:

  
PROJECT GUIDE

  
PRINCIPAL  
The National College  
Jayanagar, Bangalore-70.

HEAD OF THE DEPARTMENT

  
Head, Dept of English  
The National Degree College  
(Autonomous), 7th Block  
Jayanagar, Bangalore - 70.



  
PRINCIPAL  
The National College  
Jayanagar, Bangalore-70



|| ಶ್ರದ್ಧಾಹಿ ಪರಮಾ ಗತಿಃ ||

THE NATIONAL COLLEGE  
JAYANAGAR

**CERTIFICATE**

This is to certify the project report titled "CASE STUDY ON'INFOSYS COMPANY" is a bonafide record of work done by SUMUKHA M L (20NCJB705) of THE NATIONAL COLLEGE, Jayanagar, Bengaluru, in partial fulfilment of the requirements of IV Semester BCA[IoT] during the year 2021 -2022.

HEAD OF THE DEPARTMENT

*Rajni*  
PROJECT GUIDE

Examiners:

1.

2.

Examination Centre

The National College,  
Jayanagar.

Date of Examination:

*[Signature]*  
Head, Dept of English  
The National Degree College  
(Autonomous) 7th Block,  
Jayanagar, Bangalore - 70.

*[Signature]*  
PRINCIPAL  
The National College  
Jayanagar, Bangalore-70.



*[Signature]*  
PRINCIPAL  
The National College  
Jayanagar, Bangalore-70

Infosys Company





# THE NATIONAL COLLEGE

Autonomous

Jayanagar, Bangalore-560070

॥ ಶ್ರದ್ಧಾಹಿ ಪರಮಾ ಗತಿಃ ॥

## CERTIFICATE

This is to certify that the study report titled “CASE STUDY ON NOKIA” is a bonafide record of work done by SriHari BG of the class 4th Semester BCA [IOT], THE NATIONAL COLLEGE, Jayanagar, Bangalore, during the year 2021-2022.

HEAD OF THE DEPARTMENT

PROJECT GUIDE

Examiners:

1.

  
PRINCIPAL  
The National College  
Jayanagar, Bangalore-70.

2.

Examination Center:

The National College,  
Jayanagar.

Date of Examination:

  
Head, Dept of English  
The National Degree College  
(Autonomous) 7th Flr  
Jayanagar, Bangalore-70.



  
PRINCIPAL  
The National College  
Jayanagar, Bangalore-70.



# THE NATIONAL COLLEGE

Autonomous

Jayanagar, Bangalore-560070

ಶ್ರದ್ಧಾಹಿ ಪರಮಾ ಗತಿಃ ||

## CERTIFICATE

This is to certify the project report on "RESEARCH OF A COMPANY" titled "ZOMATO" is a bonafide record of work done by SHASHANK H E (20NCJB703) of THE NATIONAL COLLEGE, Jayanagar, Bengaluru, in partial fulfilment of the requirements of IV Semester BCA[IoT] during the year 2021-2022.

*Shash*

STUDENT SIGNATURE

*Chit*

PROJECT GUIDE

*D. Sudh*

PRINCIPAL

The National College  
Jayanagar, Bangalore-70

HEAD OF THE DEPARTMENT

*Chit*  
Head, Dept of English  
The National Degree  
(Autonomous)  
Jayanagar, Bai



*Byani - lb*

PRINCIPAL

The National College  
Jayanagar, Bangalore-70



# THE NATIONAL COLLEGE

Autonomous

Jayanagar, Bangalore - 560070

ಶ್ರದ್ಧಾಹಿ ಪರಮಾ ಗತಿಃ ||

## CERTIFICATE

This is to certify that the project report on "RESEARCH OF A COMPANY" titled "CAPGEMINI" is a bonafide record of work done by **Nayana N [20NCJB711]** of the class 4th Semester BCA [IOT], TECHNICAL ENGLISH, THE NATIONAL COLLEGE, Jayanagar, Bangalore, during the year 2021-2022.

STUDENT SIGNATURE :

*Nayana N*

PROJECT GUIDE :

*[Signature]*  
PRINCIPAL  
The National College  
Jayanagar, Bangalore-70.

HEAD OF THE DEPARTMENT *[Signature]*



*[Signature]*  
PRINCIPAL  
The National College  
Jayanagar, Bangalore-70.

*[Signature]*  
Head, Dept of English  
The National Degree College  
(Autonomous) 7th Block,  
Jayanagar, Bangalore - 70.



**THE NATIONAL COLLEGE**

Autonomous

Jayanagar, Bangalore-560070

**CERTIFICATE**

This is to certify that the project report entitled "CASE STUDY ON Xiaomi company is a Bonafide record of work done by JITHENDRA SHARMA V(20NCJB701) of THE NATIONAL COLLEGE, Jayanagar, Bangalore, in partial fulfilment of the requirements of IV Semester BCA [INTERNET OF THINGS], TECHNICAL ENGLISH during the year 2021-2022.

STUDENT SIGNATURE:

JITHENDRA SHARMA V(20NCJB701)

DATE OF EXAMINATION:

HEAD OF THE  
DEPARTMENT  
GUIDE

PROJECT  
GUIDE

PRINCIPAL  
The National College  
Jayanagar, Bangalore-70.

Head, Dept of English  
The National Degree College  
(Autonomous) 7th Block  
Jayanagar, Bangalore - 70.



PRINCIPAL  
The National College  
Jayanagar, Bangalore-70.



॥ ಶ್ರದ್ಧಾಡಿ ಪರಮಾ ಗತಿಃ ॥

## THE NATIONAL COLLEGE

Autonomous

Jayanagar, Bangalore - 560070

### CERTIFICATE

This is to certify that the project report entitled **CASE STUDY ON NIKE** is a bonafide record of work done by **VISHAL S (20NCJB709)** of **THE NATIONAL COLLEGE, Jayanagar, Bangalore**, in partial fulfilment of the requirements of **IV Semester BCA [INTERNET OF THINGS], TECHNICAL ENGLISH** during the year **2021-2022**.

STUDENT SIGNATURE: 

VIHAL S (20NCJB709)

PRINCIPAL

The National College  
Jayanagar, Bangalore-70.

DATE OF EXAMINATION:

  
PROJECT GUIDE

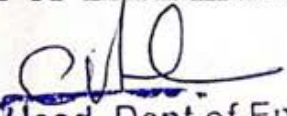
  
Head, Dept of English  
The National Degree College  
(Autonomous) 7th Block,  
Jayanagar, Bangalore - 70.

HEAD OF THE DEPARTMENT

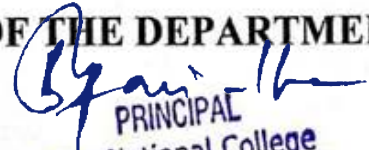
  
PRINCIPAL  
The National College  
Jayanagar, Bangalore-70.







# THE NATIONAL COLLEGE

AUTONOMOUS

JAYANAGAR, BANGALORE 560-070

॥ ಶ್ರದ್ಧಾಹಿ ಪರಮಾ ಗತಿಃ ॥

## CERTIFICATE

This is to certify the Research of the Company titled "ACCENTURE" is a bonafide record of work done by **AKASH A JAIN** of **The National College, Jayanagar, Bangalore** in partial fulfilment of the requirements of **4<sup>th</sup> Semester, BCA [IoT], Technical English** during the year **2021-22**.

Head, Dept of English  
The National Degree College  
(Autonomous) 7th Block  
Jayanagar, Bangalore-70



*[Signature]*

PRINCIPAL  
The National College  
Jayanagar, Bangalore-70.

**HEAD OF THE DEPARTMENT**

*[Signature]*  
Head, Dept of English  
The National Degree College  
(Autonomous) The National College  
Jayanagar, Bangalore-70.

*[Signature]*  
**PROJECT GUIDE**

**Date of Examination:**

**Student Signature:**

*Akash A*

[AKASH A JAIN]





**THE NATIONAL COLLEGE  
JAYANAGAR BANGALORE-560070**

ಶ್ರದ್ಧಾಪಿ ಪರಮಾ ಗತಿಃ ॥

**CERTIFICATE**

This is to certify the project report titled "CASE STUDY ON "MAGICPIN" is a bonafide record of work done by **BHARATH U (20NCJB710)** of **THE NATIONAL COLLEGE, Jayanagar, Bengaluru**, in partial fulfilment of the requirements of **IV Semester BCA[IoT]** during the year **2021 -2022**.

**HEAD OF THE DEPARTMENT**

  
**PROJECT GUIDE**

Examiners :

Examination Centre

1.

  
**PRINCIPAL**  
The National College  
Jayanagar, Bangalore-70.

The National College,  
Jayanagar.

2.

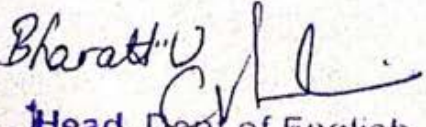
  
**Head, Dept of English**  
The National Degree College  
(Autonomous) 7th Block,  
Jayanagar, Bangalore - 70.

Date of Examination:

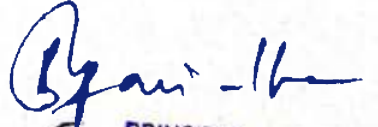

  
**PRINCIPAL**  
The National College  
Jayanagar, Bangalore-70.



Little Bluejays  
CARE PVT LTD

### LITTLE BLUEJAYS CARE PVT LTD

Dear sir/ Madam

This is to certify that Miss.Nayana Thara.R student of Psychology from National College attended Little Bluejays care Pvt Ltd for internship program from 1<sup>st</sup> June to 25th June 2018. During her internship period she has observed the Early Intervention services given to the kids with Autism, ADHD, Intellectual Deficit, and Genetic Disorder. The center works with the Interdisciplinary Model where they provide Behaviour Modification therapy, Cognitive Behavior Therapy, Occupational Therapy, Physiotherapy, Speech therapy and Special education. The center also provides Screening, Consultation and Assessment depending on the need of the child condition for which detailed report is issued.

She has observed the whole process and therapies conducted in the center. She has submitted one detailed case history report and case summary reports of the clients which she has observed. During the internship period she has shown immense interest and genuine willingness to learn, and zeal to take new assignments given to her.

We wish Nayana Thara.R all the very best for her future.

*Kruthika.V*

Warm Regards  
Kruthika.V  
Msc Clinical Psychology  
Little Bluejays Care Pvt Ltd.

Psychologist  
Little Blue Jays Care







# SPANDANA HEALTH CARE

No.236/2, 29th Main, 5th Block, Nandini Layout, (Coconut Garden), Near Ring Road Bridge,  
Bangalore - 560 096. Phone : 23595652 / 9035560000 / 9036680000  
CIN - U05110KA2004PTC034140

Ref:

Date: 16/12/2019

This is to state that **Mr. Prajwal Raghavendra. R.** (Roll no: 17NCJA046) student of third year B.A Psychology Programme, at **The National College**, Bangalore, had attended his internship programme, from December 06<sup>th</sup> 2019 to December 20<sup>th</sup> 2019 at **Spandana Health Care**, Nandini Layout, Bangalore.

During his tenure as an intern at Spandana Health Care, he was actively involved in observing clinical interviews and assessments carried out for patients at the hospital. Also, he participated in various activities at the hospital such as group counselling sessions, psychoeducational activities and individual/group supervision hours for interns at the hospital. He showed his interest in learning/understanding various mental health disorders and was consistent in completing the assigned tasks of the internship programme.

We wish him all the success for his future endeavours.

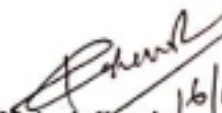
  
Dr Mahesh Gowda 16/12/19  
Managing Director  
Spandana Health Care

**SPANDANA HEALTH CARE**  
Sy. No. 236/2, 29th Main, 5th Block,  
Nandini Layout, (Coconut Garden)  
Near Ring Road, Bridge, Bangalore-06

*Committed to Mental Health Care*



Dated, 7th December 2020

TO WHOMSOEVER IT MAY CONCERN

This is to certify that **Mr. ADARSH N** bearing Register No. **18NCJC668** , B.Com final year student, **The National College, Autonomous, Jayanagar, Bangalore** has successfully completed a internship of six weeks (from 24-10-2020 to 05-12-2020 ) under the guidance of **H. THIMMARAJU. BE. CIVIL** (Name & Designation – Department) at this organization, towards the fulfillment of award of “Bachelor of Commerce” during the year 2020 – 2021.

During the period of his internship he has exhibited punctuality and diligence.

We wish him every success in life.

Thanking You,

for DISHA ENGINEERING.,

For DISHA ENGINEERING



Proprietor



PRINCIPAL  
The National College  
Jayanagar, Bangalore-70.





# G.M. GROUP OF INDUSTRIES

A UNIT OF PRINTING AND PACKAGING  
Mfrs. Of corrugated boxes, printing cartons, E-Flute cartons

+919844341931

+917353989828

DATE : 5<sup>th</sup> December 2020

## CERTIFICATE

This is to certify that **MS. Aishwarya Melmari (REG NO: 18NCJC602) BCOM** student of **THE NATIONAL COLLEGE JAYANAGARA, BANGLORE** has undergone internship for a period from **27<sup>th</sup> October to 5<sup>th</sup> December 2020** in our GM Group of Industries , Bangalore under guidance of Soumya A J-HR Executive.

During the above period the performance and conduct of **MS Aishwarya Melmari** has been satisfactory.

For Gm Group Of Industries



Narayanaswamy B.G

PROPRIETER

  
PRINCIPAL  
The National College  
Jayanagar, Bangalore-70.



To whomsoever this may concern

This is to certify that Ms. Aishwarya S. bearing Register No. **18NCJC706**, **B. Com** final year student, **The National College, Autonomous, Jayanagar, Bangalore** has successfully completed an internship of six weeks (from 7 October 2020 to 30 November 2020) under the guidance of A. N. Venkatesh, Financial Controller & Company Secretary at this organisation, towards the fulfilment of award of "Bachelor of Commerce" degree during the year 2020-2021.

During the period of her internship she has exhibited punctuality and diligence. We wish her every success in life.

For Nordson India Private Limited

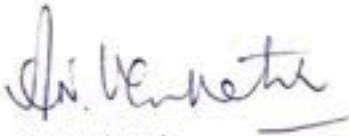

**A N Venkatesh**  
Financial Controller & Company Secretary



**PRINCIPAL**  
**The National College**  
**Jayanagar, Bangalore-70.**

Date: 1 December 2020

Place: Bangalore





To,  
Mr. Arun Kumar,  
HOD- Dept. of Commerce,  
The National College, Jayanagar,  
Bengaluru-560070.

**Sub : Letter of Internship acceptance**

This is to certify that **Mr. Akash** pursuing his B.com in **The National College (Autonomous) Jayanagar, Bengaluru-560070**, he has started his internship in our firm form **1st March 2021**.

Area of Specification :

**Gathering & Analyzing Information,  
Event Management, Digital Marketing, etc**

**Mr. Akash is guided by Mr. Venkata Sainath Assistant Project Manager.**  
**He will complete his Internship by 30th March 2021.**



*[Handwritten Signature]*  
PRINCIPAL  
The National College  
Jayanagar, Bangalore-70.

For VARADA INNOVATIONS

*[Handwritten Signature]*  
Proprietor  
**Venkata Sainath**  
Manager

## TO WHOM IT MAY CONCERN

This is to certify that **Mr. AKASH ADIGA B** bearing Register No. **18NCJC603** student of B.com Final Year, The National College (Autonomous), Jayanagar, Bangalore worked as an intern at VSS Innovative Technologies, Bangalore from 16 November 2020 to 31 December 2020 on the internship program titled **Bachelor of Commerce**. During the tenure here, he worked hard and delivered the assigned work at the stipulated time. VSS Innovative Technologies wishes all success in his career.

VSS Innovative Technologies



Authorized Signatory

*[Handwritten Signature]*  
PRINCIPAL  
The National College  
Jayanagar, Bangalore-70.



This is to certify that **Mr. ANUP P** bearing **Register No. 18NCJC669**, B. Com final year student, **The National College, Autonomous**, Jayanagar, Bangalore has successfully completed internship of six weeks (*from 05/11/2020 to 19/12/2020*) under the guidance of **Mr. Gurudeva, Accountant** at the organization, towards the fulfillment of award of "Bachelor of Commerce" during the year 2020-2021.

During the period of his internship, he exhibited punctuality and diligence. We wish him every success in life.

Date: 19-12-2020

Place: Bangalore



For EAZYWAY CORPORATE CONSULTING PVT LTD

*O. Suneel Kumar*  
Director/ Authorized Signatory  
Signature

*D. Sush*  
PRINCIPAL  
The National College  
Jayanagar, Bangalore-70.



Date: 04-08-2021

**INTERNSHIP COMPLETION CERTIFICATE**

This is to certify that **Mr.Arjun.M** being registered No.18NCJC671 has completed the internship of 45 days in our organisation M/s.Stayfit Health & Fitness World Pvt Ltd in Accounts & Finance Department under the guidance of Mr.Narasimha Reddy ( Manager - Accounts & Finance ).

For Stayfit Health &amp; Fitness World Pvt Ltd

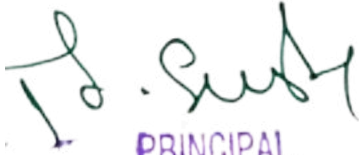

  
PRINCIPAL  
The National College  
Jayanagar, Bangalore-70.



**STAYFIT HEALTH AND FITNESS WORLD PRIVATE LIMITED (SPL)**  
STAYFIT TOWERS # 580, 11th Main, 36th Cross, 5th Block, Jayanagar, Bangalore-41. INDIA

*Exercise for healthy living*

Corporate Office:

Tel: 080 4121 3333, 4080 0000

Toll Free No. 1800 102 9000

E-stayfit@stayfitindia.com

www.stayfitindia.com

www.stayfitmagazine.com



# Powernet Solutions Pvt Ltd.

No. 7&8, Jalaram Industrial Estate, Arekere Gate,  
Bannerghatta Road, Bangalore - 560 076  
Tele : 080-2648 7741 / 2648 7761  
CIN : U31909KA1999PTC025040  
GST No. : 29AABCP7283Q1Z1

## CERTIFICATE

This is to certify that Ms. ARPITHA.V bearing Register No. 18NCJC605, B.Com final year student, The National College, Autonomous, Jayanagar, Bangalore has successfully completed a internship of six weeks *from 12-10-2020 to 21-11-2020* under the guidance of SANDEEP GOWDA, Accountant, Accounts Department at this organization, towards the fulfillment of award of "Bachelor of Commerce" during the year 2020 - 2021.

During the period of her internship she has exhibited punctuality and diligence.

We wish her every success in life.

OF POWERNET SOLUTIONS PVT. LTD

T. S. Bhageerathi  
DIRECTOR

Signature

Date: 23-11-2020.



*[Signature]*  
PRINCIPAL  
The National College  
Jayanagar, Bangalore-70.



8<sup>th</sup> January 2021

## CERTIFICATE OF INTERNSHIP

This is to certify that Ms. Ashwini.V bearing Reg No: 18NCJC672, B.com final year student, the National college, Autonomous, jayanagar, Bangalore has successfully completed her internship of six weeks from 05<sup>th</sup> November 2020 to 30<sup>th</sup> December 2020 under the guidance of preethi (HR department) in our organization, towards the fulfillment of award of "Bachelor of commerce" during the year 2020-2021

During the period of her internship, she has exhibited punctuality and diligence.

We wish her every success in life.

Thanks & Regards



Director- Admin & Technical

  
PRINCIPAL  
The National College  
Jayanagar, Bangalore-70.







**ಭಾರತ ಎಲೆಕ್ಟ್ರಾನಿಕ್ಸ್**  
**भारत इलेक्ट्रॉनिक्स**  
**BHARAT ELECTRONICS**

**भारत इलेक्ट्रॉनिक्स लिमिटेड**

(भारत सरकार का उद्यम, रक्षा मंत्रालय)  
उत्पाद विकास एवम् नवोन्मेष केंद्र  
जालहल्ली पोस्ट, बेंगलूरु-560 013, भारत

**BHARAT ELECTRONICS LIMITED**  
(A Govt. of India Enterprise, Ministry of Defence)  
**Product Development & Innovation Centre**  
Jalahalli Post, Bengaluru-560 013, India.

फोन / Phone :

फैक्स / Fax :

ईमेल / E-mail :

सं/No: 6050/HR/PDIC/PT-110/2020-21

दिनांक/Date: 10.12.2020

**(उत्पाद विकास ए नवोन्मेष केंद्र)**  
**PRODUCT DEVELOPMENT INNOVATION CENTRE**

**प्रमाण-पत्र - CERTIFICATE**

This is to certify that Mr. Chandan Mallu R, Register No. 18NCJC606, student of the The National College, Autonomous, Jayanagar Bangalore has undergone Internship in BEL Six weeks (from 27.10.2020 to 10.12.2020) and has undergone Orientation in "PDIC/Finance".

He was regular and punctual and his conduct was satisfactory during period.

*Thimmaiah*  
**SR./ASST. HR OFFICER**  
**(HR)/PDIC**

ಶಿರ್ಮಾ ಅಜ್ಜ / THIMMAIAH K M  
206140

ವಿಂಚ ಸಹಾಯಕ ಮಾನವ ಸಂಪನ್ಮೂಲ ಅಧಿಕಾರಿ  
SR. ASST. H R OFFICER  
ಪ್ರತಿಭೆ ಮತ್ತು / PD & IC



*Chandan Mallu R*  
**PRINCIPAL**  
**The National College**  
**Jayanagar, Bangalore-70.**

# CERTIFICATE

## TO WHOM SO EVER IT MAY CONCERN

This is to certify that **Mr. CHETHAN.V** (REG: 18NCJC673) from NATIONAL COLLEGE ,JAYANAGAR BANGLORE, he has successfully completed his Internship/Project training starting from **05-10-2020 to 25-11-2020[45 days]** the project titled **“STUDY ON CASHFLOW STATEMENT AT PRABHUDAS LILLADHER PVT LTD, Bangalore”**.

On completion of the project, he has submitted a report of the above studies.

We wish all the best for his future Endeavour's.

DATE: 05/12/2020

PLACE: BANGALORE

  
SIGNATURE



  
PRINCIPAL  
The National College  
Jayanagar, Bangalore-70.



**Prabhudas Lilladher Pvt. Ltd.**

Regd Office: 3rd Floor, Sadhana House, 570, P.B.Marg, Worli, Mumbai - 400 018 | Tel. + 91 22 6632 2222 | Fax. + 91 22 6632 2229  
CIN: U67199MH1983PTC029670 Compliance Officer: **Mr. A. Subrahmanian** | Email: asubrahmanian@plindia.com

SEBI REGN No - BSE (Cash/F&O) INB/F 010502855, NSE (Cash/F&O/Currency Derivatives) INB/F/E 230597738  
CDSL - IN DP CDSL 14 99 DP ID 12011390, NSDL - IN DP NSDL 329 2010 DP ID IN303868 PMS - INP000001231, AMFI ARN - 3276

Dated 21 December 2020

**INTERNSHIP COMPLETION LETTER**

This is certify that Mr **DEEPAK G** bearing register No **18ncjc674 B.com** final year student. **THENATIONAL COLLEGE, AUTONOMOUS** Jayanagara, Bangalore has successfully completed internshipOf six weeks (from 9-11-2020 to 19-12-2020) Under the guidance of **MR RAHUL** Exide life InsuranceRelationship Manger at the organization towards the fulfilment of award of Bachelor of CommerceDuring the year 2020-2021.

During the period of him internship he exhibited punctuality and diligence.We wish him every success in life.

*Rahul Nimane*

Exide Life Insurance Company Limited  
3rd Floor, JP Techno Park  
No. 3/1, Millers Road  
Bengaluru - 560 001

Registered Office

Exide Life Insurance company  
BMR Sankeerna, No 18, 1<sup>st</sup> Cross, 6<sup>th</sup> Main, MICO Layout  
BTM 2<sup>nd</sup> Stage, Bangalore 560076, India

*D. Sudh*

PRINCIPAL

The National College  
Jayanagar, Bangalore-70





CHETAN ENTERPRISES  
#56, Near Bus stop, Devarachikknahalli,  
Bangalore-560076



CHETAN ENTERPRISES

This is to certify that **Mr.Dhanush D S** bearing register number **18NCJC718 B.com** final year student , **The National College, Autonomous, Jayanagar, Bangalore** has successfully completed internship of seven weeks (from **07/11/2020** to **22/12/2020**) under the guidance of **Mr.Chetan C V**, proprietor of the enterprise, towards the fulfilment of award of "Bachelor of commerce" during the year 2020-2021.

Signature and Seal of the company authorized person or head

For CHETAN ENTERPRISES

*Chetan C V*  
Proprietor

Date: 18/03/2021  
Place: Bangalore

*D. Sush*  
PRINCIPAL  
The National College  
Jayanagar, Bangalore-70.





# KNND ASSOCIATES PVT. LTD.

This is to certify that **Mr. DURGAPRASAD K. C** bearing *Register No. 18NCJC675* B. Com final year student, **The National College, Autonomous**, Jayanagar, Bangalore has successfully completed an internship of six weeks (*from 05-10-2020 to 18-11-2020*) under the guidance of **N. P. RAVISHANKAR** (**Accounts and Finance Manager**) at this organization, towards the fulfillment of award of "Bachelor of Commerce" during the year 2020 –2021.

During the period of his internship he has exhibited punctuality and diligence.  
We wish him every success in life.

For KNND ASSOCIATES PVT. LTD.

*N.P. Ravishankar*  
Authorized Signatory

Signature and Seal of the company authorized person or head  
(Optional – with Name and Designation of signed person)

Date: 21.11.2020  
Place: Bangalore

*T. S. Suresh*  
PRINCIPAL  
The National College  
Jayanagar, Bangalore-70.



## Registered Office:

'KNND HOUSE' No. 153-166/1 East End Main Road, J.P Nagar,  
Bengaluru - 560078 // Tel: 080-26588870 [www.knndassociates.com](http://www.knndassociates.com)

GSTIN : 29AABCK3022G1ZV | CIN : U05150KA1999PTC025205 | IEC NO. : 0705001202

# LAKSHMI MANJUNATH ENTERPRISES

NO 1351, Muthayamma Temple Road, Hebbagodi Bangalore 560099

GST NO: 29ANWPL5315Q1ZY

## INTERNSHIP CERTIFICATE

This is to certify that **Mr. FRANKLIN PRAKASH** bearing *Register No.18NCJC676*, B.Com final year student, **The National College, Autonomous**, Jayanagar, Bangalore has successfully completed an internship of six weeks (*from 02/11/2020 to 14/12/2020*) under the guidance of **Mr. Harsih – Manager** at this organization, towards the fulfillment of award of “Bachelor of Commerce” during the year 2020 – 2021.

During the period of his internship he has exhibited punctuality and diligence. We wish him every success in life.



Signature and Seal of the company authorized person or head

Date: 15/12/2020

Place: Bengaluru

  
PRINCIPAL  
The National College  
Jayanagar, Bangalore-70.





Dated: 24<sup>th</sup> December 2020

To whomsoever it may concern

This is to certify that **Mr. Gajendra.V** bearing register no. **18NCJC677** B.Com final year student, **The National College**, Autonomous, Jayanagar, Bangalore has successfully completed an internship of six weeks (from **30.10.2020 to 10.12.2020**) under the guidance of **Mr. Shuvendu Das, Assistant Finance Manager, Finance department** at our organization, towards the fulfillment of award of "Bachelor of Commerce" during the year 2020-2021.

The topic of his internship was '**Study and analysis of Financial Statements and Introduction to Managerial Accounting**'

During the period of his internship he has exhibited punctuality and diligence. We wish him every success in life.

*Shuvendu Das*  
24/12/20  
Name: Shuvendu Das  
Designation: Asst Manager Finance



Date: 24<sup>th</sup> December 2020  
Place: Bengaluru. Karnataka

**Virisa Icosys Technology Private Limited**  
130, Bull temple Road  
Basavanagudi  
Bengaluru-560018



*To. Gajendra*  
PRINCIPAL  
The National College  
Jayanagar, Bangalore-70.



## TO WHOM IT MAY CONCERN

This is to confirm you that Ms. GOPINATH YADAV has selected as a HR-Intern at VSS Innovative Technologies, Bangalore from 8th March 2021. During the tenure, you are going to learn and do the work and follow the office guidelines. In this Internship period you are not going to get any stipend. VSS Innovative Technologies wishes all success in your career.

VSS Innovative Technologies

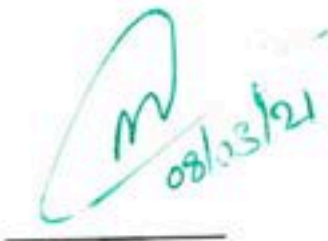

Authorized Signatory



PRINCIPAL  
The National College  
Jayanagar, Bangalore-70.



25<sup>th</sup> November 2020

### CERTIFICATE OF INTERNSHIP

This is to Certify that Ms. Harshitha K bearing Reg No : 18NCJC678, B.com final year student, The National College, Autonomous, Jayanagar, Bangalore has successfully completed her internship of six weeks from 5<sup>th</sup> Oct to 19<sup>th</sup> Nov 2020 under the guidance of Manivannan - Accounts Manager (Accounts & Finance Department) in our organization, towards the fulfillment of award of "Bachelor of Commerce" during the year 2020 – 2021.

During the period of her internship, she has exhibited punctuality and diligence.

We wish her every success in life

Thanks & Regards,



M. Dhanasekaran  
Director – Admin & Technical



PRINCIPAL  
The National College  
Jayanagar, Bangalore-70.





# Karnataka Plastoo Industries (P) Ltd.



DMN. OFF. & FACTORY :

110/E & F, Bommasandra Industrial Area, Hebbagodi Village, BANGALORE - 560 099

Phone : 2783 2459 / 2783 2460 / 4165 8088 / 41658089 Fax : 2783 6461

mail : accounts@kplastoind.com / ceo@kplastoind.com

IN NO : U25200KA1971PTC002098

This is certify that Miss. **HEMASHREE T S** bearing Register No **18NCJC679**, B.COM final year student, **THE NATIONAL COLLEGE, AUTONOMOUS**, JAYANAGAR, Bangalore has successfully completed a internship of six weeks (from 01-10-2020 to 14-11-2020) under the guidance of **Mr. SUDHRASAN S., Accounts Officer** of the organization, towards the fulfilment of award of "Bachelor of commerce" during the year 2020-2021.

During the period of her internship she exhibited punctuality and diligence. We wish her every success in life.

Signature

Date: 16-11-2020

Place: Bangalore

For Karnataka Plastoo Industries (P) Ltd

Authorised Signatory

9/3/20/1306/18



*S. Sudh*  
PRINCIPAL  
The National College  
Jayanagar, Bangalore-70.





prakash

Roadlines Private Limited

Regd. Office : # 108, 3rd Cross, Kalasipalyam New Ext., Bengaluru - 560 002. Phone : 22220293  
Corporate Office : # 3, Dr. M.H. Marigowda Road, Near Lalbagh, Bengaluru - 560 027  
Phone : 22238676, 22232625, 22215123, 22220705 Fax : 080-22236005  
PAN NO - AABCP2953K / CIN - U85110KA1961PTC001423 / GST NO - 29AABCP2953K1Z3  
Email : corporate@prakashroadlines.com

This is to certify that **Ms. JAHNAVI S G** bearing Register Number **18NCJC641**, B.com Final Year student, **The National College, Autonomous, Jayanagar, Bangalore** has successfully completed internship of seven weeks (from **31/12/2020** to **31/01/2021**) under the guidance of **Mrs. NIRMALA C**, Personnel Officer towards the fulfillment of award of "Bachelor of Commerce" during the year 2020-2021.

FOR PRAKASH ROADLINES PRIVATE LIMITED

*Nirmala C*

NIRMALA C  
PERSONNEL OFFICER



Date: 31/01/2021  
Place: Bangalore

*D. Sush*

PRINCIPAL  
The National College  
Jayanagar, Bangalore-70.



# DHANUKA ENTERPRISES PRIVATE LIMITED

CIN U14101KA1997PTC083498

GSTN 29AABCK4261B1ZU



This the certify that **Ms Jhansi K** bearing register No. **18NCJC732**, B Com Final Year student, **THE NATIONAL COLLEGE, AUTONOMOUS**, Jayanagar, Bangalore has successfully completed a internship of six weeks (from 13-10-2020 to 03-12-2020) under the guidance of **Mr. Amit Dhanuka, Director of Dhanuka Enterprises Pvt Ltd.** at this organization, towards the fulfilment of award of 'Bachelor of Commerce' during the year 2020-2021.

During the period of her internship she exhibited punctuality and diligence. we wish her every success in life.



Signature

Date: 03-12-2020

Place: Bangalore



PRINCIPAL  
The National College  
Jayanagar, Bangalore-70.

POCO  
SHOT ON POCO F





Date: 03-Dec-2020

## INTERNSHIP COMPLETION CERTIFICATE

This is to certify that **Jithendra R (18NCJC 680)** student Of **National College Jayanagar** has successfully completed her/his Internship In **Accounting and Finance at Mlewzklawz IT Solutions Pvt Ltd.** in our organization period from 19-Oct-2020 to 02-Dec-2020.

Her/His Performance and conduct during this period was good. We wish all the best in future endeavour.

For Mlewzklawz IT Solutions Pvt. Ltd.

Thanks and regards,

Kavita Solanki

7411000877



PRINCIPAL  
The National College  
Jayanagar, Bangalore-70.



**IDEAL CARPETS LIMITED**  
**EXPORT DYEING & SPINNING**

RECOGNIZED EXPORT HOUSE BY GOVERNMENT OF INDIA



**Dated- 20-11-2020**

REGD OFFICE  
RAJNAGAR, G.T ROAD,  
GOPINAGU, 221302  
DIST- BHADRAK (KA) INDIA  
PHONE: (08414) 23275, 23245  
FAX: (08414) 232475, 232475  
Email: [info@idealcarpets.net](mailto:info@idealcarpets.net)

**TO WHOM SO EVER IT MAY CONCERN**

This is to certify that Ms Jyoti Yadav, Reg No: (18NCJC719) has joined our organization as an intern on 01 st October till 19th November. Her study period was for 50 days.

She has completed her organization studies in 4 divisions of our organization which includes production, spinning, dyeing and managerial department.

During the study period her performance was found to be excellent. We wish all the success in the future endeavours.

For : Ideal Carpet Limited

  
Kudan Arya  
Marketing Head

  
PRINCIPAL  
The National College  
Jayanagar, Bangalore-70.



# FUTURE RETAIL



DATE: 21-JUNE-2021

## CERTIFICATE

This is to certify that Ms. KARTHIKA.K the student of 5<sup>th</sup> semester B.COM bearing REG NO : 17NCJC418 studying in THE NATIONAL COLLEGE has done project report on "Organizational Study with Reference to Big Bazaar, Bangalore" in our organization for a period of **One month**

During her tenure with us, we found her to be sincere, diligent and hardworking and her participation in the above program was observed to be satisfactory.

FOR FUTURE RETAIL LIMITED,

**SANJANA S RAO**  
Senior Executive-Human Resource.

**BIG BAZAAR-Gate Way**  
(A Division of Future Value Retail Ltd.)  
Gateway Jayanagar, 45/1  
Marehalli, J.P. Nagar, 2nd Phase  
BANGALORE-560 069

**PRINCIPAL**  
The National College  
Jayanagar, Bangalore-70







# G.M. GROUP OF INDUSTRIES

A UNIT OF PRINTING AND PACKAGING  
Mfrs. Of corrugated boxes, printing cartons, E-Flute cartons

+919844341931

+917353989828

DATE : 5<sup>th</sup> December 2020

## CERTIFICATE

This is to certify that **MS. Aishwarya Melmari (REG NO: 18NCJC602) BCOM** student of **THE NATIONAL COLLEGE JAYANAGARA, BANGLORE** has undergone internship for a period from **27<sup>th</sup> October to 5<sup>th</sup> December 2020** in our GM Group of Industries , Bangalore under guidance of Soumya A J-HR Executive.

During the above period the performance and conduct of **MS Aishwarya Melmari** has been satisfactory.

For Gm Group Of Industries



Narayanaswamy B.G

PROPRIETER

  
PRINCIPAL  
The National College  
Jayanagar, Bangalore-70.





Date: 20-Nov-2020

## INTERNSHIP COMPLETION CERTIFICATE

This is to certify that **Kavya .B(18NCJC682)** student Of **National College Jayanagar** has successfully completed her/his Internship In **Accounting and Finance at Mlewzklawz IT Solutions Pvt Ltd.** in our organization period from 05-Oct-2020 to 20-Nov-2020.

Her/His Performance and conduct during this period was good. We wish all the best in future endeavour.

For Mlewzklawz IT Solutions Pvt. Ltd.

Thanks and regards,

Kavita Solanki

7411000877



PRINCIPAL

The National College  
Jayanagar, Bangalore-70.





**Smitam®**

(A National NGO Registered Under Societies Registration Act of 1960)  
(Registration Year 2018-19, Registration No. JPN-4-00056-2018-19)  
No. 234 Doddakalasangra, Kanakapura Main Road, Bangalore 560062  
Phone No: +91 6366680903 Email: smitam.ngo@gmail.com

Date: 23/12/2020

This is to certify that **Mrs Keerthana .S** bearing Register NO. **18NCJC708**, B.com final year student , **The National College , Autonomous , Jayanagar , Bengaluru** has successfully completed an internship from 9/11/2020 – 23/11/2020 , under the guidance of **Mrs MANDAARA HEBBAR BV** , Volunteer's management lead at the organization , towards the fulfillment of award of "Bachelor of commerce" during the year 2020-2021 .

During the period of her internship she exhibited punctuality and diligence . We wish her every success in life .

*M.A.*

Smitam  
234, Doddakalasangra  
Kanakapura Main Road  
Bangalore - 560062

Signature with seal

Date: 23/12/2020

Place: Bengaluru

*To. Smitam*  
PRINCIPAL  
The National College  
Jayanagar, Bangalore-70.







**DARSHAN  
PIXEL PRINTS**

## CERTIFICATE

This is to certify that **Mr. KIRAN.V.A** bearing Register No. **18NCJC615, B.COM** final year student of "The National College, Autonomous", Jayanagar, Bangalore has successfully completed an internship of six weeks from 23-11-2020 to 06-01-2021 under the guidance of **MURALIDHAR**, CEO of the organisation, towards the fulfillment of award of "Bachelor of Commerce" during the year 2020-2021.

During the period of his internship, he has exhibited punctuality and diligence.

We wish him every success in his future endeavors.

For **DARSHAN PIXEL PRINTS LLP**

For **DARSHAN PIXEL PRINTS LLP**

Authorized Signatory

**AUTHORIZED SIGNATORY**

Date : 18-01-2021

Place : Bangalore

  
**PRINCIPAL**  
**The National College**  
**Jayanagar, Bangalore-70.**



**DARSHAN PIXEL PRINTS LLP**

27/4A2, JIGANI LINK ROAD, BOMMASANDRA INDUSTRIAL AREA, BANGALORE - 562 105  
(T) : 27839064, 27839065 e-mail : darshanpixelprints@gmail.com

## CERTIFICATE

Date: 14/12/2020

This is to certify that **Mr. Kishore Kumar D** ( Reg No – 18NCJC683), B. Com student from The National College has completed his internship named "**ORGANISATION STUDY**" in our establishment from 02/11/2020 to 05/12/2020

During his Internship, **Mr. Kishore Kumar D** spent quality time with all department. He got a broad insight into the company and got introduced top various departments.

We wish his all success in future endeavours

**For HDFC BANK LTD**

**(Ankit Kumar Kashyap)**

**Preferred Manager**



*[Handwritten Signature]*  
**PRINCIPAL**  
**The National College**  
**Jayanagar, Bangalore-70**



This is to certify that **Mr.KISHORE.N** bearing Register No.18NCJC616.com Final Year Student ,  
**THE NATIONAL COLLEGA ,Autonomous ,JayanagarBanglore** has Successfully Completed a  
internship of Seven weeks (from10-11-2020 to 24-12-2020) under the guidance of **Mr.Nithin**  
,Manager –HR at the organization,toward the fulfillment of award of" bachelor of commerce"  
during the year 2020-2021

During the period of his intership he exhibited punctuality and diligen.we wish him every  
success in life.

Date: 24-12-2020

Place:Banglore

*Nithin*  
*24/12/2020*

Signature

Reliance Retail Ltd.  
Sarala Grand Hyper Mart  
CMC Khata No. 1402,  
Bilekahalli Village, Begur Hobli,  
Bannerghatta Main Road,  
BANGALORE - 560 076.

*D. Sush*  
PRINCIPAL  
The National College  
Jayanagar, Bangalore-70.







To,  
Kumar Prasad  
3<sup>rd</sup> year student  
National College  
**Bangalore**  
Email: [Kumarprasad123@gmail.com](mailto:Kumarprasad123@gmail.com)

**DATE: 15 March 2021**  
**Place: Bangalore**

Dear Mr. Kumar Prasad,

Subject: Offer Letter for Internship

As sited in the above subject, we are pleased to offer you the position of "Intern — Marketing" at ARKA Eduserve Pvt Ltd. Bangalore.

Please find the following confirmations of the specifics of your Internship.

- **Position Title:** Intern-Marketing
- **Start Date:** March 15, 2021
- **End Date:** April 13, 2021
- **Number of working hours :** 30 hours per week
- **Reporting Relationship/Supervisor:** You will be reporting to Mr. Rajiv BV, Head- Operations and Marketing of ARKA Eduserve Pvt LTD, Bangalore.  
Mr. Rajiv may be contacted by phone +919900080647 or  
by email; [Rajiv@jgishschools.in](mailto:Rajiv@jgishschools.in)



*[Handwritten Signature]*  
PRINCIPAL  
The National College  
Jayanagar, Bangalore-70



**CERTIFICATE**

This is to certify that **Mr. Lakshmikanth N** bearing Register No. 18NCJC618, B Com Final year student of "The National College, Autonomous", Jayanagar, Bangalore has been Successfully completed an internship of six weeks from 26/10/2020 to 05/12/2020 under the guidance of Mr. Anand T(Manager) at the organization, towards the fulfillment of award of "Bachelor of Commerce" during the year 2020-2021.

During the period of his internship, he has exhibited punctuality and diligence.

We wish him every success in his future endeavors.

For Girias Investment Pvt Ltd  
**GIRIAS INVESTMENT PVT. LTD.**  
No. 178, Kathriguppe Main Road,  
BSK 3rd Stage, Bangalore - 560085

Anand T  
(Manager)

Date: 10/12/2020  
Place: Bangalore

**PRINCIPAL**  
**The National College**  
Jayanagar, Bangalore-70.



Registered Office

# 47, 3rd Floor, 15th Cross, 3rd Main, Margosa Road,  
Malleshwaram, Bangalore - 560 003.

25<sup>th</sup> November 2020

### CERTIFICATE OF INTERNSHIP

This is to Certify that Ms. Lakshmi Priya, bearing Reg No : 18NCJC684, B.com final year student, The National College, Autonomous, Jayanagar, Bangalore has successfully completed her internship of six weeks from 5<sup>th</sup> Oct to 19<sup>th</sup> Nov 2020 under the guidance of Manivannan - Accounts Manager (Accounts & Finance Department) in our organization, towards the fulfillment of award of "Bachelor of Commerce" during the year 2020 – 2021.

During the period of her internship, she has exhibited punctuality and diligence.

We wish her every success in life

Thanks & Regards



M Dhanasekaran  
Director – Admin & Technical



PRINCIPAL  
The National College  
Jayanagar, Bangalore-70.







# Powernet Solutions Pvt Ltd.

No. 788, Jalaram Industrial Estate, Arekere Gate,

Bannergatta Road, Bangalore - 560 076

Tele : 080-2648 7741 / 2648 7761

CIN : U31909KA1999PTC025040

GST No. : 29AABCP7283Q1Z1

## CERTIFICATE

This is to certify that Ms. LAVANYA.N bearing Register No. 18NCJC619, B.Com final year student, The National College, Autonomous, Jayanagar, Bangalore has successfully completed a internship of six weeks from 12-10-2020 to 21-11-2020 under the guidance of SANDEEP GOWDA Accountant, Accounts Department at this organization, towards the fulfillment of award of "Bachelor of Commerce" during the year 2020 – 2021.

During the period of her internship she has exhibited punctuality and diligence.

We wish her every success in life.

of POWERNET SOLUTIONS PVT. LTD

T. S. Bhageesathi  
DIRECTOR  
Signature

Date: 23-11-2020,  
Place: Bangalore.



T. S. Subh  
PRINCIPAL  
The National College  
Jayanagar, Bangalore-70.





**DARSHAN**  
PIXEL PRINTS

## CERTIFICATE

This is to certify that **Mr.LIKITH B.M** bearing Register No. **18NCJC621, B.COM** final year student of "The National College, Autonomous", Jayanagar, Bangalore has successfully completed an internship of six weeks from 23-11-2020 to 06-01-2021 under the guidance of **MURALIDHAR**, CEO of the organisation, towards the fulfillment of award of "Bachelor of Commerce" during the year 2020-2021.

During the period of his internship, he has exhibited punctuality and diligence.

We wish him every success in his future endeavors.

For **DARSHAN PIXEL PRINTS LLP**

**AUTHORIZED SIGNATORY**

Date : 18-01-2021

Place : Bangalore

**PRINCIPAL**  
The National College  
Jayanagar, Bangalore-70.



**DARSHAN PIXEL PRINTS LLP**

27/4A2, JIGANI LINK ROAD, BOMMASANDRA INDUSTRIAL AREA, BANGALORE - 562 105

(T) : 27839064, 27839065 e-mail : darshanpixelprints@gmail.com



Ref: GRID / INTERNSHIP/2020

19<sup>th</sup> December, 2020

**TO WHOMSOEVER IT MAY CONCERN**

CERTIFICATE

This is to certify that Likith Gowda, Reg No. 18NCJC685, Bcom final year student of The National College, Jayanagar, Autonomous, Jayanagar, Bangalore has successfully completed an Internship of six weeks from 4th Nov 2020 to 19th Dec 2020 under the guidance of Mrs. Vani S.P, HR Administration at "GRID R&D" BANGALORE towards the fulfilment of " Bachelor of Commerce" during the year 2020 - 2021

We found him punctual, agile and efficient.

We wish him prosperity in the posterity.

for GRID R & D

Vani S.P  
HR Administration

PRINCIPAL  
The National College  
Jayanagar, Bangalore-70.

**GRID R&D**  
1980, 3rd Floor, 26th Cross,  
7th Main, BSK 2nd Stage,  
Bangalore-70





Ref :

Date :

This is to certify that **Mr. H K LOHITH GOWDA** bearing *Register No. 17NCJC483* , B.Com final year student, **The National College, Autonomous, Jayanagar, Bangalore** has successfully completed a internship of six weeks (*from 09/11/2020 to 19/12/2020 )* under the guidance of **Mr. PRASAD, FINANCE MANAGER**, at this organization, towards the fulfillment of award of "Bachelor of Commerce" during the year 2020 – 2021.

During the period of his internship he has exhibited punctuality and diligence.  
We wish him/her every success in life.



**KALPATARU AGRO SUPPLIES**  
No,112/7, Ground Floor,  
Panthara Palya, R.R. Nagar,  
Bengaluru - 560 039.

Date:  
Place:

Signature and Seal of the company authorized person or head



  
PRINCIPAL  
The National College  
Jayanagar, Bangalore-70.

Date: 19.12.2020

Place: Bangalore

**TO WHOM SO EVER IT MAY CONCERN**

This is to certify that Mr./Ms. R L Madhusudhan Reddy bearing Register No.18NCJC722, B.Com final year student, The National College, Autonomous, Jayanagar, Bangalore has successfully completed a internship under the Guidance of "Integra Office Solutions "at this organization, towards the fulfillment of award Of "Bachelor of Commerce" during the year 2020 – 2021.

During the period of his internship he has exhibited punctuality and diligence.

We wish him/her every success in life.

For Integra Office Solutions



  
PRINCIPAL  
The National College  
Jayanagar, Bangalore-70.





# SLV ENTERPRISES PVT. LTD.

**SLV AQUA KING™**  
(Packing Drinking Water)



# 9, Prathibha Industrial Estate, Yelachenahalli, Kanakapura Main Road, Bangalore - 560 078.  
E-mail : slvaquaking@gmail.com / slvbiolofuel@gmail.com • Website : www.slvgroups.in  
Phone : 080 26666612, Mob. : 9986013879

This is to certify that **Ms.MANASA L** bearing *Register No. 18NCJC622*,  
B. Com final year student, **The National College, Autonomous, Jayanagar,**  
Bangalore has successfully completed a internship of six weeks (*from*  
*11/11/2020 to 25/12/2020*) under the guidance of **T. T NAGESH,**  
**COMPANY DIRECTOR** at this organization, towards the fulfillment of  
award of "Bachelor of Commerce" during the year 2020 – 2021.

During the period of her internship she has exhibited punctuality and  
diligence. We wish her every success in life.

FOR SLV ENTERPRISES PVT LTD

Date : 12/03/2021

Place : Bangalore

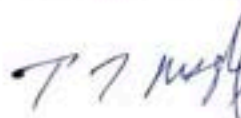
  
T.T NAGESH  
(DIRECTOR)



  
PRINCIPAL  
The National College  
Jayanagar, Bangalore-70.



**SLV Aqua King™**  
Package Drinking Water

**SLV Biom Surya**  
Stove & Pellets

**SLV Land Developers**  
& Builders

**SLV Water Tanker**  
Supply

**SLV Commercial**  
Gas Distributer



This is to certify that Mr. **MANOJ.S** bearing Register No. **18NCJC687**, B.Com final year student, **The National college, Autonomous**, Jayanagar, Bangalore has successfully completed a internship of seven weeks (from 19-10-2020 to 03-12-2020) under the guidance of **Mr. M N SHIVARAMAKRISHNAN**, Accounts and Admin manager at the organization, towards the fulfillment of award of "Bachelor of commerce" during the year 2020-2021.

During the period of his internship he exhibited punctuality and diligence.  
We wish him every success in life.

Signature

Date: 03-12-2020

Place: Bangalore



*[Handwritten Signature]*  
PRINCIPAL  
The National College  
Jayanagar, Bangalore-70.



18.11.2020

## CERTIFICATE

This is to certify that **Mr. Manu N M.** (Reg No-18NCJC624), B. Com student from The National College has completed his internship named "**Organisational Study**" in our establishment from 20.10.2020 to 12.11.2020.

During his Internship, **Mr. Manu N M** spent quality time with All department. He got a broad insight into the company and got introduced to various departments.

We wish him all success in future endeavors.

FOR SANSERA ENGINEERING LTD.,



(MANOJ KUMAR B M)  
ASST. MANAGER – HR



PRINCIPAL  
The National College  
Jayanagar, Bangalore-70.



**SANSERA ENGINEERING LIMITED**

(Formerly Sansera Engineering Pvt Ltd)

This is to certify that **Mr. Nanjunde Gowda M** bearing Register No **18NCJC725**, B.Com final year student. **The National College Autonomous Jayanagar**, Bangalore has successfully completed a internship of six weeks (from **25/07/2020** to **07/09/2020**) under the guidance of **Mr. Aravinda B, Managing director** at this organization towards the fulfillment of award of "Bachelor of Commerce during the year 2020 - 2021.

During the period of his internship, he has exhibited punctuality and diligence. We wish him every success in life.

**For Xtreme Media solutions Pvt. Ltd.**



Authorized Signatory

**Aravinda B**

**Managing director**

**PRINCIPAL**  
**The National College**  
**Jayanagar, Bangalore-70.**

Date: 07/09/2020

Place: Bengaluru



---

**Xstream Media Solutions Pvt. Ltd.**

2<sup>nd</sup> Floor, 8<sup>th</sup> F Main Rd, Jayanagar East, Jaya Nagara 1<sup>st</sup> Block, Jayanagar,  
Bengaluru, Karnataka 560011 aravidna@xstream biz 8971519734





www.eicher.in/etb

android motors (p) ltd.

(formerly BMSS PVT. LTD.)  
CIN. U50401KA1983PTC005388

AUTHORISED DEALER TRUCKS AND BUSES

### CERTIFICATE

This is to certify that Mr. Naveen Kumar R bearing Register No. 18NCJC626, B.Com final year student of "The National College, Autonomous", Jayanagar, Bangalore has successfully completed an internship of six weeks from 01-10-2020 to 15-11-2020 under the guidance of Antony Thomas, Director of Finance, at the organization, towards the fulfillment of award of "Bachelor of Commerce" during the year 2020-2021.

During the period of his internship, he has exhibited punctuality and diligence.

We wish him every success in his future endeavors.

For Android Motors Private Limited

Antony Thomas  
Director(Finance)

Date : 13.01.2021  
Place: Bangalore



Registered Office :  
"Kantha Court", 2nd Floor, No. 132/9/10,  
Lalbagh Road, Bangalore - 560 027  
tel : + 91 - 80 - 4114 6403, 4114 6404  
2222 2263, 2222 0056  
fax : + 91 - 80 - 2229 0213  
email : info@androidmotors.com

Service Centre :  
# 53/2, 53/3,  
9th K. M. Hosur Road,  
M.B.T. Compound,  
Bommanahalli, Bangalore - 58.  
tel : + 91 - 80 - 4110 8287

Survey No. 27/2,  
Next to Kailash Body Builders,  
Balagaranahalli, Hosur Road,  
Attibele, Bangalore - 107.  
tel : + 91 - 80 - 2782 0279

Bangalore Bypass,  
NH-75, Madanahalli Post  
Kondarajannahalli Gate,  
Kolar - 563101.  
tel : + 91 - 80 - 52295999

Shop No-1, Kurubanpet Road  
Near Reliance Petrol Bunk,  
Hoskote, Bangalore  
Rural Dist - 562 114  
tel : + 91 7406544545  
+ 91 9972656795

18.11.2020

CERTIFICATE

This is to certify that **Mr. Nithin J.** (Reg No-18NCJC627), B. Com student from The National College has completed his internship named "**Organisational Study**" in our establishment from 20.10.2020 to 12.11.2020.

During his Internship, **Mr. Nithin J** spent quality time with All department. He got a broad insight into the company and got introduced to various departments.

We wish him all success in future endeavors.

FOR SANSERA ENGINEERING LTD.,



(MANOJ KUMAR B M)  
ASST. MANAGER – HR



PRINCIPAL  
The National College  
Jayanagar, Bangalore-70.





# SLV ENTERPRISES PVT. LTD.

SLV AQUA KING™  
(Packing Drinking Water)



# 9, Prathibha Industrial Estate, Yelachenahalli, Kanakapura Main Road, Bangalore - 560 078.  
E-mail : slvaquaking@gmail.com / slvbiofuel@gmail.com • Website : www.slvgroups.in  
Phone : 080 26666612, Mob. : 9986013879

This is to certify that **Ms. .NIVIDITHA K** bearing *Register No. 18NCJC628*, B. Com final year student, **The National College, Autonomous, Jayanagar, Bangalore** has successfully completed a internship of six weeks (*from 11/11/2020 to 25/12/2020*) under the guidance of **T . T NAGESH , COMPANY DIRECTOR** at this organization, towards the fulfillment of award of "Bachelor of Commerce" during the year 2020 – 2021.

During the period of her internship she has exhibited punctuality and diligence. We wish her every success in life.

FOR SLV ENTERPRISES PVT LTD

Date: 12/03/2021

Place: Bangalore

T.T NAGESH

( DIRECTOR )



*T. T. Nagesh*  
PRINCIPAL  
The National College  
Jayanagar, Bangalore-70.

SLV Aqua King™  
Package Drinking Water

SLV Biom Surya  
Stove & Pellets

SLV Land Developers  
& Builders

SLV Water Tanker  
Supply

SLV Commercial  
Gas Distributer



# BRAHMA BREW WORKS

# 35/38, 24<sup>th</sup> Main Road, Puttenhalli, JP Nagar 7<sup>th</sup> Phase,

Bengaluru - 560078. Enquiry : 7483197213

GSTIN : 29AMKPR9019A2ZT | PAN: AMKPR9019A



Date: November 15, 2020

## Sub : Certificate of completion

This is to certify that Ms . Pallavi SR Regd. No. 18NCJC690 student of B. Com. 5<sup>th</sup> Semester at National College Jayanagar, Bengaluru has successfully completed her project work on the topic "Organizational Study" during the period of October 1, 2020 to November 15, 2020 in our organization under the guidance of Mr. Raghab Joshi (Operations Manager).

She has shown extensive interest in the project work that was worth appreciating. We wish her a bright future.



  
PRINCIPAL  
The National College  
Jayanagar, Bangalore-70.





This is to certify that **Mr. Pavan Kumar .N** bearing Register No. 18NCJC631

B.Com final year student , **The National College, Autonomous , Jayanagar**

Bangalore has successfully completed a internship of six weeks from

19.10.2020 to 01.12.2020 under the guidance of **Shivu Accounts Manager** at

The organization , towards the fulfilment of award of "Bachelor of Commerce"

During The year 2020-2021 .

During the period of his internship he has exhibited punctuality and diligence.

We wish him every success in life.

Arvee Hydraulics  
For ARVEE HYDRAULICS

Authorized Signatory

Date : 12.12.2020

Place : Bangalore



*[Signature]*  
PRINCIPAL  
The National College  
Jayanagar, Bangalore-70.

## CERTIFICATE

Date: 14/12/2020

This is to certify that **Miss. Pavithra C** ( Reg No – 18NCJC632), B.COM STUDENT from the National College has completed her Internship name "**ORGANISATION STUDY**" in our establishment from 02/11/2020 to 05/12/2020.

During her Internship, **Miss. Pavithra C** spent quality time with all department. He got a broad insight into the company and got introduce to various departments.

We wish her all success in future endeavours.

For HDFC BANK LTD



Ankit Kashyap  
Preferred Manager

  
PRINCIPAL  
The National College  
Jayanagar, Bangalore-70.







This is to certify that **Mr./Ms. POOJA KASHYAP S** bearing *Register No. 18NCJC710*, B.Com final year student, **The National College, Autonomous, Jayanagar, Bangalore** has successfully completed a internship of six weeks (*from 27<sup>TH</sup> OCT to 10<sup>TH</sup> DEC 2020*) under the guidance of **MS. POOJASHREE R (COO)** at this organization, towards the fulfillment of award of "Bachelor of Commerce" during the year 2020 – 2021.

During the period of his internship, she has exhibited punctuality and diligence. We wish him/her every success in life.

Signature of the company authorized person  
(Chief operating officer)

Date: 10/12/2020  
Place: Bangalore.



PRINCIPAL  
**The National College**  
Jayanagar, Bangalore-70.

## CERTIFICATE

Date: 14/12/2020

This is to certify that **Miss. Pavithra C** ( Reg No – 18NCJC632), B.COM STUDENT from the National College has completed her Internship name "**ORGANISATION STUDY**" in our establishment from 02/11/2020 to 05/12/2020.

During her Internship, **Miss. Pavithra C** spent quality time with all department. He got a broad insight into the company and got introduce to various departments.

We wish her all success in future endeavours.

For HDFC BANK LTD



Ankit Kashyap  
Preferred Manager



PRINCIPAL  
The National College  
Jayanagar, Bangalore-70.





# Findx Pro

Redefine yourself

#569, 1st Floor, 30th main, Banagiri nagar, BSK 3rd stage, Bengaluru-85

Ref:

Date: 05/03/2021

To,  
Mr. Arun Kumar  
HOD-Dept.of Commerce,  
National Degree College,  
7th Block, Jayanagar,  
Bengaluru-560070

Sub: Rotational Internship Letter- Mr. Prajwal U (Reg No.16NCJC536)

This is to certify that Mr. Prajwal U Reg No.16NCJC536 has joined our Organisation on 8 March 2021 and he will be working as internship trainee in **Production, Sales and Accounts** Department in our **FINDX PRO** for the period of 28-30days.

FINDX PRO

*Arun Kumar*

*Sudh*  
PRINCIPAL  
The National College  
Jayanagar, Bangalore-70.





# Sneha Clothing

# 5, Shamanna Garden, Jayanahalli,  
Chunchagatta Main Road, J.P. Nagar - post,  
Bangalore - 560 078 Phone: 080 2653 0157  
Email: snehacreation.bottoms@gmail.com  
GST: 29ACEFS8387C120

This is to certify that Mr. PRAMODKUMAR.S bearing Register No.18NCJC634 B.Com final year student, The National College, Autonomous, Jayanagar, Bangalore has successfully completed a internship of six weeks (from 24<sup>th</sup> Oct.2020 to 7<sup>th</sup> Dec.2020) under the guidance of Nataraja M – Accounts Manager at this organization, towards the fulfilment of award of "Bachelor of Commerce" during the year 2020 – 2021.

During the period of his internship he has exhibited punctuality and diligence. We wish him every success in life.

  
(Nataraja M – Accounts Manager)

Date: 22/12/2020

Place: Bangalore

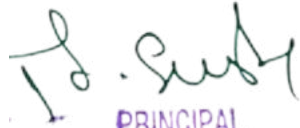
  
PRINCIPAL  
The National College  
Jayanagar, Bangalore-70.



This is certify that Miss. **PRATHIBHA R** bearing Register No. **18NCJC692**, B.Com final year student, **THE NATIONAL COLLEGE, AUTONOMOUS**, Jayanagar, Bangalore has successfully completed a internship of six weeks (from 14-10-2020 to 28-11-2020) under the guidance of **Mr. FIROZE**, Business Head at the organization, towards the fulfillment of award of "Bachelor of commerce" during the year 2020-2021.

During the period of her internship she exhibited punctuality and diligence. We wish her every success in life.

  
Signature

Date: 28-11-2020

Place: Bangalore

  
PRINCIPAL  
The National College  
Jayanagar, Bangalore-70.





**MARKETONIX**  
YOUR VISION IS OUR MISSION

Ref No: MSPL16052021

Date: 16/05/2021

TO WHOM IT MAY CONCERN

To,  
**MS. PREETHI J**  
(Interns)

**Sub: Experience Letter**

It is to certify that **MS.Preethi.J** was working as Interns with us as interns from period **08<sup>th</sup> March, 2021** to **07<sup>th</sup> April 2021** as per the **Marketonix's** employment record.

During her employment, **MS.Preethi.J** has perused knowledge & experience in our organization.

During her period, we found her to be Professional, knowledgeable and result oriented with theoretical & practical understanding of work requirements.

Overall she performed her duties and responsibilities cheerfully with attention to detail at all times. With her enthusiasm to work, learn and progress, I am certain that she would make a great employee to any enterprise.

For, Marketonix Services Private Limited.

Yours Sincerely,

HR TEAM  
**MARKETONIX SERVICES PRIVATE LIMITED**



*[Signature]*

**PRINCIPAL**  
**The National College**  
Jayanagar, Bangalore-70.



Bangalore | Delhi | Bhubaneswar | USA |

Bangalore-69, Ph-080-41511188, Email -[info@marketonix.com](mailto:info@marketonix.com), [www.marketonix.com](http://www.marketonix.com)





**Bengaluru Urban, Bengaluru Rural & Ramanagara  
District Co-operative Milk Producers' Societies Union Ltd., Bengaluru-29**

No.Bamul/Admn-10/cert/N-38/2020-21

Date:05.02.2021

**CERTIFICATE**

This is to certify that **Ms.Priya.H.R**, Reg.No.18NCJC636,  
Student of The National College Studies B.com part of  
Curriculum has undertaken project entitled as "**Organisation  
Study**" at Bengaluru Urban, Bengaluru Rural and Ramanagara  
District Co-operative milk producer's Societies Union Ltd., during  
10.11.2020 to 10.12.2020.

  
**General Manager(Admn)**  
**Bengaluru Co-op Milk Union Ltd.,**

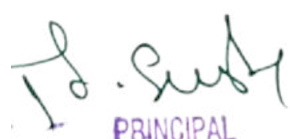
  
**PRINCIPAL**  
**The National College**  
**Jayanagar, Bangalore-70.**





**Bengaluru Urban, Bengaluru Rural & Ramanagara  
District Co-operative Milk Producers' Societies Union Ltd., Bengaluru-29**

No.Bamul/Admn-10/cert/N-38/2020-21

Date:05.02.2021

**CERTIFICATE**

This is to certify that Ms.Priya.H.R, Reg.No.18NCJC636,  
Student of The National College Studies B.com part of  
Curriculum has undertaken project entitled as "Organisation  
Study" at Bengaluru Urban, Bengaluru Rural and Ramanagara  
District Co-operative milk producer's Societies Union Ltd., during  
10.11.2020 to 10.12.2020.

  
General Manager(Admn)

Bengaluru Co-op Milk Union Ltd.,



PRINCIPAL

The National College  
Jayanagar, Bangalore-70.



# FUTURE RETAIL

DATE: 16-DECEMBER-2020

## CERTIFICATE

This is to certify that Ms. PRIYANKA D the student of 5<sup>th</sup> semester B.COM bearing USN NO : 18NCJC638 studying in The National College has done project report on "Organizational Study with reference to Big Bazaar " for a period of six weeks During her tenure with us, we found her to be sincere, diligent and hardworking and her participation in the above program was observed to be satisfactory.

FOR FUTURE RETAIL LIMITED,

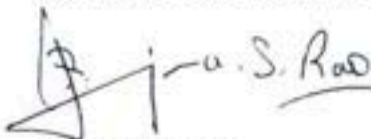

**SANJANA S RAO**  
Human Resource.  
People Office



**PRINCIPAL**  
The National College  
Jayanagar, Bangalore-70.

**BIG BAZAAR**  
Kothanur Village, Utharahalli Hobli,  
Puttenahalli, RBI Layout, J.P. Nagar,  
BANGALORE-560078



### Future Retail Limited

1. Store Address : RBI Layout, Puttenahalli, J.P. Nagar, Kothanur Village, Utharahalli Hobli, Bangalore-560078.
2. Zonal Office : 1st Floor Pasadena, 18/1, 10th Main, Ashoka Pillar Road, Jayanagar 1st Block, Bangalore - 560 011. India T : +91 80 433040000 F : +91 80 26577530
3. Regd Off: Knowledge House, Shyam Nagar, Off Jogeshwari-Vikhroli Link Road, Jogeshwari (East), Mumbai 400 060. T: +91 22 30841300 F: +91 22 66442201





This is to certify that **Mr./Ms. PUNITHA R** bearing *Register No.18NCJC711*, B.Com final year student, **The National College, Autonomous, Jayanagar, Bangalore** has successfully completed a internship of six weeks (*from 27<sup>TH</sup> OCT to 10<sup>TH</sup> DEC 2020*) under the guidance of **MS. POOJASHREE R (COO)** at this organization, towards the fulfillment of award of "Bachelor of Commerce" during the year 2020 – 2021.

During the period of his internship, she has exhibited punctuality and diligence. We wish him/her every success in life.

Signature of the company authorized person  
(Chief operating officer)

Date: 10/12/2020  
Place: Bangalore.

PRINCIPAL  
The National College  
Jayanagar, Bangalore-70.



This is to certify that **Mr.RAJU.K** bearing Register No.**18NCJC641**.com Final Year Student , **THE NATIONAL COLLEGA ,Autonomous ,JayanagarBanglore** has Successfully Completed a internship of Seven weeks (from**10-11-2020** to **24-12-2020**) under the guidance of **Mr.Nithin ,Manager –HR** at the organization,toward the fulfillment of award of" bachelor of commerce" during the year 2020-2021

During the period of his intership he exhibited punctuality and diligen.we wish him every success in life.

Date: 24-12-2020

Place:Banglore

*Nithin*  
*24/12/2020*

Signature

Reliance Retail Ltd.  
Sarala Grand Hyper Mart  
CMC Khata No. 1402,  
Bilekahalli Village, Begur Hobli,  
Bannerghatta Main Road,  
BANGALORE - 560 076.

*D. Sush*

PRINCIPAL

The National College  
Jayanagar, Bangalore-70.





**Smitam®**

(A National NGO Registered Under Societies Registration Act of 1960)  
(Registration Year 2018-19, Registration No. JPN-4-00056-2018-19)  
No. 234 Doddakalasangra, Kanakapura Main Road, Bangalore 560062  
Phone No: +91 6366680903 Email: smitam.ngo@gmail.com

---

Date: 23/12/2020

This is to certify that **Mrs Raksha .R** bearing Register NO. **18NCJC712**, B.com final year student , **The National College , Autonomous , Jayanagar , Bengaluru** has successfully completed an internship from 9/11/2020 – 23/11/2020 , under the guidance of **Mrs MANDAARA HEBBAR BV** , Volunteer's management lead at the organization , towards the fulfillment of award of "Bachelor of commerce" during the year 2020-2021 .

During the period of her internship she exhibited punctuality and diligence . We wish her every success in life .

SMITAM  
No. 234, 55  
Kanakapura Main Rd  
BANGALORE - 560

Signature with seal

PRINCIPAL  
The National College  
Jayanagar, Bangalore-70.

Date: 23/12/2020

Place: Bengaluru





**CERTIFICATE**

This is to certify that **Mr. Rakshith M** bearing Register No. 18NCJC643, B Com Final year student of "The National College, Autonomous", Jayanagar, Bangalore has been Successfully completed an internship of six weeks from 26/10/2020 to 05/12/2020 under the guidance of Mr. Anand T(Manager) at the organization, towards the fulfillment of award of "Bachelor of Commerce" during the year 2020-2021.

During the period of his internship, he has exhibited punctuality and diligence.

We wish him every success in his future endeavors.

For Girias Investment Pvt Ltd

**GIRIAS INVESTMENT PVT. LTD.**  
No. 78, Kathriguppe Main Road,  
BCK 3rd Stage, Bangalore - 560085

Anand T  
(Manager)

Date: 10/12/2020

Place: Bangalore

  
PRINCIPAL  
The National College  
Jayanagar, Bangalore-70.





# Sigma Networks

*Technology Forcives*

# 362, 5th Main, Hampinagar, R.P.C. Layout  
Vijayanagar, Bangalore - 560 040.  
Ph : 080-23388652, 9620351959  
E-mail : accounts@sigmanetworks.co.in

This is to certify that **Mr. RANJAN T S** bearing Register No. **18NCJC645** ,  
B.Com final year student, **The National College, Autonomous**, Jayanagar,  
Bangalore has successfully completed a internship of seven weeks (from 12-  
10-2020 to 27-11-2020) under the guidance of **Mr. ANIL KUMAR**,  
MANAGER - HR at the organization, towards the fulfillment of award of  
"Bachelor of commerce" during the year 2020-2021.

During the period of his internship he exhibited punctuality and diligence. We  
wish him every success in life.

  
Signature

Date: 27-11-2020  
Place: Bangalore

  
PRINCIPAL  
The National College  
Jayanagar, Bangalore-70.



**TO WHOM SO EVER IT MAY CONCERN**

**22<sup>th</sup> December 2020**

This is to certify that **Ms. Roopa N**, bearing **Register No.18NCJC649**, **B.com final year student, The National College, Autonomous, Jayanagar, Bangalore** has successfully completed a internship of six weeks (from 07.11.2020 to 22.12.2020) under the guidance of **Nagaraj B N - Executive HR** at this organization, towards the fulfillment of award of "Bachelor of Commerce" during the Year 2020.

During the Period of her internship she has exhibited punctuality and diligence.

We wish her every success in life.

**For Metro cash and carry India Pvt. Ltd,**

  
**Udaya Kumar V**

**Department Manager- HR**



  
**PRINCIPAL**  
**The National College**  
**Jayanagar, Bangalore-70.**



**METRO**

Cash & Carry India

**YOUR SUCCESS IS OUR BUSINESS**



Ref: GRID / INTERNSHIP/2020

11<sup>th</sup> December, 2020

TO WHOMSOEVER IT MAY CONCERN

### CERTIFICATE

This is to certify that **R.Sheshadhari**, Reg No. 18NCJC655, Bcom final year student of The National College, Jayanagar, Autonomous, Jayanagar, Bangalore has successfully completed an Internship of six weeks from 28th Oct 2020 to 11th Dec 2020 under the guidance of Mrs. Vani S.P, HR Administration at "GRID R&D" BANGALORE towards the fulfilment of " Bachelor of Commerce" during the year 2020 - 2021

We found him punctual, agile and efficient.

We wish him prosperity in the posterity.

for GRID R & D



Vani S.P  
HR Administration



PRINCIPAL  
The National College  
Jayanagar, Bangalore-70.





**TEACHER TRAINING INSTITUTE OF INDIA**

**भारतीय शिक्षक प्रशिक्षण संस्थान**

( An ISO 9001:2008 Certified Institution, Recognized By Govt. of India )

Ref : .....

Date : 12/1/2021

Date: 12-1-2021

**TO WHOM IT MAY CONCERN**

This is to certify that **Mr Ruthvik L** Reg No:18NCJ650 a student of BCOM, National College Bangalore has successfully completed 45 days internship programme at Teacher's training institute of India. During the period of his internship programme with us he was found punctual, hardworking and inquisitive.

We wish him every success in life,



PRINCIPAL

The National College  
Jayanagar, Bangalore-70.



For Teacher Training Institute of India  
  
Authorized Signatory

**SIENNA ECAD Technologies Private Ltd.**

**CIN : U30007KA1997PTC022754**

# 775/A, 1<sup>st</sup> & 3<sup>rd</sup> Floor, 100 Feet Ring Road  
Banashankari 3<sup>rd</sup> Stage, Bangalore - 560 085, INDIA  
Tel: + 91-80-68190700, Fax: + 91-80-26426462

**4<sup>th</sup> December 2020**

## **CERTIFICATE OF INTERNSHIP**

This is to certify that **Mr. RUTHWIK RAMAKUMAR** bearing **Register No. 18NCJC713**, B.Com final year student, **The National College**, Autonomous, Jayanagar, Bangalore has successfully completed a internship of six weeks (from 5<sup>th</sup> October to 4th December 2020) under the guidance of **Mr. Mallesh**, Deputy Manager – Finance at this organization, towards the fulfillment of award of "Bachelor of Commerce" during the year 2020 — 2021.

During the period of his internship he has exhibited punctuality and diligence.

We wish him/her every success in life.

**For Sienna Ecad Technologies Pvt Ltd**

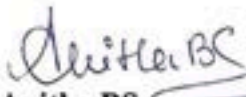

**Anitha BS**  
Deputy Manager - HR



**PRINCIPAL**  
**The National College**  
Jayanagar, Bangalore-70.







To,

Sachin Kumar K  
3<sup>rd</sup> year student  
National College  
**Bangalore**  
Email: [sachinkumar\\_123@gmail.com](mailto:sachinkumar_123@gmail.com)

DATE: 15 March 2021

Place: Bangalore

Dear Mr. Sachin Kumar K,

Subject: Offer Letter for Internship

As sited in the above subject, we are pleased to offer you the position of "Intern — Marketing" at ARKA Eduserve Pvt Ltd. Bangalore.

Please find the following confirmations of the specifics of your Internship.

- **Position Title:** Intern-Marketing
- **Start Date:** March 15, 2021
- **End Date:** April 13, 2021
- **Number of working hours :** 30 hours per week
- **Reporting Relationship/Supervisor:** You will be reporting to Mr. Rajiv BV, Head- Operations and Marketing of ARKA Eduserve Pvt LTD, Bangalore.  
Mr. Rajiv may be contacted by phone +919900080647 or by email; [Rajiv@jgischools.in](mailto:Rajiv@jgischools.in)

  
PRINCIPAL  
The National College  
Jayanagar, Bangalore-70.





**Bengaluru Urban, Bengaluru Rural & Ramanagara  
District Co-operative Milk Producers' Societies Union Ltd., Bengaluru-29**

No.Bamul/Admn-10/cert/N-38/2020-21

Date:05.02.2021

**CERTIFICATE**

This is to certify that Ms.Sai Shree.M.R, Reg.No.18NCJC652,  
Student of The National College Studies B.com part of  
Curriculum has undertaken project entitled as "Organisation  
Study" at Bengaluru Urban, Bengaluru Rural and Ramanagara  
District Co-operative milk producer's Societies Union Ltd., during  
10.11.2020 to 10.12.2020.

  
General Manager(Admn)  
Bengaluru Co-op Milk Union Ltd.,

  
PRINCIPAL  
The National College  
Jayanagar, Bangalore-70.





25/02/2021

## TIAN E DIE CASTING & ENGINEERING

TO WHOMSOEVER IT MAY CONCERN

TO THE HON'BLE PRINCIPAL, TIAN E DIE CASTING & ENGINEERING

This is to certify that **Mr. Sandeep A.** a student of B.Com National Degree collage Jayanagar has successfully completed 45 Days (from 15<sup>th</sup> Dec 2020 to 29<sup>th</sup> January 2021) internship program at this company

During his employment with us we have found him to be sincere and hardworking with great integrity.

We wish him all the best for his future endeavors.

Thanking you

Yours sincerely

For TIAN E DIE-CASTING AND ENGINEERING

  
Gopinath B.N.  
Human Resource

  
PRINCIPAL  
The National College  
Jayanagar, Bangalore-70.





ZERO MICROFINANCE & SAVINGS SUPPORT Pvt Ltd .  
STATE HEAD OFFICE  
#17, GROUND FLOUR , SHIVASHAKTHI NAGAR, CHUNCHAGATTA MAIN  
ROAD, NEAR GREEN VALLEY SCHOOL, BANGLORE-560062  
Mobile no : 9448487705



DATE : 03-03-2020

To.  
**Head of Department**  
NATIONAL DEGREE COLLEGE  
JAYANAGAR, BANGLORE – 560070

Dear Sir/Madam

SUBJECT : Internship letter of Mr. **SANJAY . B (18NCJC693)**

This is to certify that **SANJAY. B (18NCJC693)** has joined our Organization on 03 March 2021 and will be working as internship trainee in Accounts and Finance department in our Zero Micro Finance & Savings Support Pvt. Ltd for the period of 30 days.

Zero Micro Finance & Savings Support Pvt. Ltd .

  
Bangalore Area Manager

  
PRINCIPAL  
The National College  
Jayanagar, Bangalore-70.





ITC Limited  
INDIA TOBACCO DIVISION  
Meenakunte Village  
Jala Hobli  
Bengaluru (North) - 562 157  
INDIA  
Tel : 0091 - 80-28467709/10/11/13/14/15  
Fax : 0091 - 80-28467707

December 18, 2020

**TO WHOMSOEVER IT MAY CONCERN**

This is to certify that Mr. Sanjay B.G, of The National College, Bengaluru bearing Reg. No. 18NCJC731 has successfully completed an "Organisation Study" at ITC Limited, Bengaluru Factory from 21<sup>st</sup> October, 2020 to 04<sup>th</sup> December, 2020.

He has done this Study under the guidance of Ms. Sruthi Sainath of HR Department.

He has completed this Study to the satisfaction of all concerned.

We wish him all the best in his future endeavours.

ITC LIMITED

**HUMAN RESOURCES MANAGER**



PRINCIPAL  
The National College  
Jayanagar, Bangalore-70.



Dated: 12<sup>th</sup> March 2021

## To whomsoever it may concern

This is to certify that **Mr. Shashank B S** bearing register no. **18NCJC694** B.Com final year student, The National College, Autonomous, Jayanagar, Bangalore has successfully completed an internship of six weeks (from **12.10.2020** to **04.12.2020**) under the guidance of **Mr Pawan Khemka** at our organization, towards the fulfillment of award of "Bachelor of Commerce" during the year 2020-2021.

The topic of his internship was "**Accounting, Financial Consulting and Audit**"

During the period of his internship he has exhibited punctuality and diligence. We wish him every success in life.

For, Choice Consultancy Services Private Limited



Neha Jain

Authorized Signatory

  
PRINCIPAL  
The National College  
Jayanagar, Bangalore-70.



### **Choice Consultancy Services Private Limited**

Choice House, Shree Shakambhari Corporate Park, Plot No 156-158, J.B. Nagar, Andheri (East), Mumbai - 400 099. CIN No. U72900MH2010PTC196603  
Tel.: +91-22-6707 9999 Telefax.: +91-22-6707 9859 E-mail Id.: info@choiceindia.com Website.: www.choiceindia.com



## CERTIFICATE

### TO WHOM SO EVER IT MAY CONCERN

This is to certify that **Mr. SHASHANK. M** (REG: 18NCJC695) from NATIONAL COLLEGE ,JAYANAGAR BANGLORE, he has successfully completed his Internship/Project training starting from **05-10-2020 to 25-11-2020[ 45 days]** the project titled **"STUDY ON CASHFLOW STATEMENT AT PRABHUDAS LILLADHER PVT LTD, Bangalore"**.

On completion of the project, he has submitted a report of the above studies.

We wish all the best for his future Endeavour's.

DATE: 28-11-2020

PLACE: BANGALORE

  
SIGNATURE



  
PRINCIPAL  
The National College  
Jayanagar, Bangalore-70.

**Prabhudas Lilladher Pvt. Ltd.**

Regd. Office: 3rd Floor, Sadhana House, 570, P.B.Marg, Worli, Mumbai - 400 018. Tel: + 91 22 6632 2222 | Fax: + 91 22 6632 2229  
CIN: U67190MH1983PTC028670 Compliance Officer: **Mr. A. Subrahmanian** | Email: asubrahmanian@plindia.com

SEBI REGN No. BSE (Cash/F&O) INB/F 010502855, NSE (Cash/F&O/Currency Derivatives) INB/F/E 230597738  
CDSE IN DP CDSE 14 99, DP ID 12011300 NSDL IN DP NSDL 329 2010 DP ID IN303668. PMS INP000001231, AMFI ARN 3276

This is certify that Miss. **SHILPA S** bearing Register No. **18NCJC696**, B.Com final year student, **THE NATIONAL COLLEGE, AUTONOMOUS**, Jayanagar, Bangalore has successfully completed a internship of six weeks (from 14-10-2020 to 28-11-2020) under the guidance of **Mr. MANJUNATH CHARY, Accounts Manager** at the organization, towards the fulfillment of award of "Bachelor of commerce" during the year 2020-2021.

During the period of her internship she exhibited punctuality and diligence. We wish her every success in life.



Date: 28-11-2020

Place: Bangalore



  
PRINCIPAL  
The National College  
Jayanagar, Bangalore-70.

ಬೆಂಗಳೂರು ನಗರ, ಬೆಂಗಳೂರು ಗ್ರಾಮಾಂತರ ಹಾಗೂ ರಾಮನಗರ ಜಿಲ್ಲಾ ಸರ್ಕಾರ  
ಹಾಲು ಉತ್ಪಾದಕರ ಸಂಘಗಳ ಒಕ್ಕೂಟ ನಿಯಮಿತ, ಬೆಂಗಳೂರು ಡೇರಿ ಪ್ರಾಂಗಣ,  
ಡಾ ಎಂ.ಹೆಚ್.ಮರೀಗೌಡ ರಸ್ತೆ ಡಿ.ಆರ್.ಕಾಲೇಜ್ ಅಂಚೆ, ಬೆಂಗಳೂರು-560029.

ಟಿಪ್ಪಣಿ:-

ದಿನಾಂಕ:- 13/03/2021

ವಿಷಯ:- PROJECT WORK ಮಾಡಿರುವ ವಿದ್ಯಾರ್ಥಿಯ ಹಾಜರಾತಿ ದೃಢೀಕರಣ ನೀಡುವ ಬಗ್ಗೆ.

ಉಲ್ಲೇಖ:-

ಈ ಮೇಲ್ಕಂಡ ವಿಷಯಕ್ಕೆ ಸಂಬಂಧಿಸಿದಂತೆ Shiva Poasad. R.

ಇವರು ದಿನಾಂಕ:- 13/11/2020 ರಿಂದ 13/12/2020 ರ ವರೆಗೆ PROJECT WORK

ಮಾಡಲು ಅನುಮತಿ ಪಡೆದು ಈ ಅವಧಿಯಲ್ಲಿ ಒಟ್ಟು 20 days

ದಿನಗಳು ಹಾಜರಾಗಿ ಭದ್ರತಾ ದಾಖಲಾತಿಯಲ್ಲಿ ಸಹಿಯನ್ನು ಮಾಡಿರುತ್ತಾರೆ. ಈ ಮಾಹಿತಿಯನ್ನು  
ತಮ್ಮ ಗಮನಕ್ಕೆ ತಂದು ಮುಂದಿನ ಕ್ರಮಕ್ಕಾಗಿ ಒಪ್ಪಿಸಿದೆ.

  
PRINCIPAL  
The National College  
Jayanagar, Bangalore-70.



  
ಮಹಿಷುಪ್ಪುರಸ್ಥಳಾಧಿಕಾರಿಗಳು  
ಬೆಂಗಳೂರು ಹಾಲು ಒಕ್ಕೂಟ  
ಬೆಂಗಳೂರು-560 029



# Karnataka Plastoo Industries (P) Ltd.

ADMN. OFF. & FACTORY :

# 110/E & F, Bommasandra Industrial Area, Hebbagodi Village, BANGALORE - 560 099

Phone : 2783 2459 / 2783 2460 / 4165 8088 / 41658089 Fax : 2783 6461

Email : accounts@kplastooind.com / ceo@kplastooind.com

CIN NO. : U25200KA1971PTC002098



This is certify that Miss. **SINDHU K** bearing Register No. **18NCJC698**, B.COM final year student, **THE NATIONAL COLLEGE, AUTONOMOUS, JAYANAGAR**, Bangalore has successfully completed a internship of six weeks (from 01-10-2020 to 14-11-2020) under the guidance of **Mr. SUDHRASAN S., Accounts Officer** of the organization, towards the fulfilment of award of "Bachelor of commerce" during the year 2020-2021.

During the period of her internship she exhibited punctuality and diligence. We wish her every success in life.

Signature

Date: 16-11-2020

Place: Bangalore

For Karnataka Plastoo Industries (P) Ltd

Authorised Signatory

9241301618



*S. Sudha*  
PRINCIPAL

The National College  
Jayanagar, Bangalore-70.



Regd. Off : Rajanna Lane, Ganigarpel, Nagarthpet Cross, Bangalore - 560 002

H.O # 270, Bommanahalli, Bangalore - 560 068

Phone : 25732440 41316028, Fax : 25732610 email bommanahalli@kplastooind.com

## TO WHOM IT MAY CONCERN

This is to certify that **Ms. SNEHA R** bearing Register No. **18NCJC699** student of B.com Final Year, The National College (Autonomous), Jayanagar, Bangalore worked as an intern at VSS Innovative Technologies, Bangalore from 12 October 2020 to 27 November 2020 on the internship program titled **Bachelor of Commerce**. During the tenure here, she worked hard and delivered the assigned work at the stipulated time. VSS Innovative Technologies wishes all success in her career.

**VSS Innovative Technologies**

  
27/11/20



Authorized Signatory

  
PRINCIPAL  
The National College  
Jayanagar, Bangalore-70.





This is to certify that **Mr./Ms. SPURTHI K G BHAT** bearing *Register No. 18NCJC729*, B.Com final year student, **The National College, Autonomous**, Jayanagar, Bangalore has successfully completed a internship of six weeks (*from 9<sup>TH</sup> NOV 2020 to 26<sup>TH</sup> DEC 2020*) under the guidance of **MS. POOJASHREE R (COO)** at this organization, towards the fulfillment of award of "Bachelor of Commerce" during the year 2020 – 2021.

During the period of his internship, she has exhibited punctuality and diligence. We wish him/her every success in life.

Signature of the company authorized person  
(Chief operating officer)

Date: 26/12/2020

Place: Bangalore.

PRINCIPAL

The National College  
Jayanagar, Bangalore-70.







This is to certify that **Mr./Ms. SPURTHI K G BHAT** bearing *Register No. 18NCJC729*, B.Com final year student, **The National College, Autonomous**, Jayanagar, Bangalore has successfully completed a internship of six weeks (*from 9<sup>TH</sup> NOV 2020 to 26<sup>TH</sup> DEC 2020*) under the guidance of **MS. POOJASHREE R (COO)** at this organization, towards the fulfillment of award of "Bachelor of Commerce" during the year 2020 – 2021.

During the period of his internship, she has exhibited punctuality and diligence. We wish him/her every success in life.

Signature of the company authorized person  
(Chief operating officer)

Date: 26/12/2020

Place: Bangalore.

PRINCIPAL

The National College  
Jayanagar, Bangalore-70.



# ROYAL INDRAPRASTHA RESTAURANT

---

Date : 12-03-2021

## CERTIFICATE

This Is To Certify That Mr Srinivasa V Reg No. 18ncjc657,  
Student Of The National Collage Studies B.com Part Of  
Curriculum Has Undertaken Project Entitled As "organisation Study"  
At Royal Indraprastha Restaurant 06/11/2020 To 21/12/2020.

  
PRINCIPAL  
The National College  
Jayanagar, Bangalore-70.



ROYAL INDRAPRASTHA RESTAURANT

  
Authorized Signatory

---

#1221, channasandra Dr Vishuvadhana Road, srinivasapura Cross,  
Rajarajeshwari Nagar Bangalore-560098

# ROYAL INDRAPRASTHA RESTAURANT

Date : 12-03-2021

## CERTIFICATE

This Is To Certify That Mr Sunil Kumar C Reg No. 18ncjc658,  
Student Of The National Collage Studies B.com Part Of  
Curriculum Has Undertaken Project Entitled As "organisation Study"  
At Royal Indraprastha Restaurant 06/11/2020 To 21/12/2020.

  
PRINCIPAL  
The National College  
Jayanagar, Bangalore-70.



ROYAL INDRAPRASTHA RESTAURANT

  
Authorized Signatory



17<sup>th</sup> April, 2021

TO WHOMSOEVER IT MAY CONCERN

CERTIFICATE

This is to certify that Ms. Sushmitha B.S student of National College, Jayanagar Autonomous has successfully completed Internship in the department of Human Resources from 17 March 2021 to 16 April 2021. During her period of stay with us, we found her to be dedicated, hardworking, loyal and sincere.

We wish her all the best for her future endeavors.

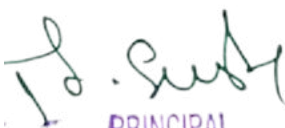
  
PRINCIPAL  
The National College  
Jayanagar, Bangalore-70.

For Apollo Hospitals, Bangalore

(A unit of Apollo enterprise Limited)

  
17/4/21

Ms Ramya Rai

Senior Manager - Human Resources





# Sigma Networks

*Technology Forever*

# 362, 5th Main, Hampinagar, R.P.C. Layout  
Vijayanagar, Bangalore - 560 040.  
Ph : 080-23388652, 9620351959  
E-mail : accounts@sigmanetworks.co.in

This is to certify that **Mr. THEJUS.P** bearing Register No. **18NCJC702** ,  
B.Com final year student, **The National College, Autonomous**, Jayanagar,  
Bangalore has successfully completed a internship of seven weeks (from 12-  
10-2020 to 27-11-2020) under the guidance of **Mr. ANIL KUMAR**,  
MANAGER - HR at the organization, towards the fulfillment of award of  
"Bachelor of commerce" during the year 2020-2021.

During the period of his internship he exhibited punctuality and diligence. We  
wish him every success in life.



Signature

Date: 27-11-2020  
Place: Bangalore



PRINCIPAL  
The National College  
Jayanagar, Bangalore-70.





# ಕರ್ನಾಟಕ ಸಾಬೂನು ಮತ್ತು ಮಾರ್ಜರ್ ನಿಯಮಿತ

(ಕರ್ನಾಟಕ ಸರ್ಕಾರದ ಸ್ವಾಮ್ಯಕ್ಕೆ ಒಳಪಟ್ಟಿದೆ)

## Karnataka Soaps & Detergents Limited

(A Government of Karnataka Undertaking)



KSDL/HRD/59[C]-A/20-21/ /

Date: 31.12.2020

### CERTIFICATE

This is to certify that **Ms.Vachana Sunderraj**, Reg No. 18NCJC662 Student of B.com. The National College, Autonomous, Jayanar, Bengaluru-560070. Has done Internship on "**Organizational Study**" at Karnataka Soaps & Detergents Limited, Bengaluru-560055, from: 09.11.2020 to 23.12.2020.

During her Internship in our Company, her performance & Conduct is good.

We wish her success in Life and Career.

  
PRINCIPAL  
The National College  
Jayanagar, Bangalore-70.



  
ASST.GENERAL MANAGER  
[Human Resource & Development]

Karnataka Soaps & Detergents Limited  
# 27, Industrial Suburb,  
Bengaluru-Pune Highway,  
Rajajinagar, Bengaluru-560 055



This is to certify that **Mr. Vaibhav Puranik** bearing Register **No.18NCJC730**, B.Com final year student, **The National College, Autonomous**, Jayanagar, Bangalore has successfully completed a internship of six weeks (from 02/11/2020.to 16/12/2020) under the guidance of **Mr. Nagaraja & Assistant Manager- Accounts** at this organization, towards the fulfillment of award of "Bachelor of Commerce" during the year 2020 – 2021.

During the period of his internship, he has exhibited punctuality and diligence. We wish him/her every success in life.

For DynPro India Pvt Ltd



Authorized Signatory

Nagaraja

Assistant Manager-Accounts

Date: 16/12/2020

  
PRINCIPAL  
The National College  
Jayanagar, Bangalore-70.

10th January 2021

To whomsoever it may concern

This is to certify that Mr.Vaibhav.V bearing Register No.18NCJC715, B.Com final year student, The National College, Autonomous, Jayanagar, Bangalore has successfully completed a internship of Six weeks from 16th November 2020 to 6th January 2021 under the guidance of Mrs. Leelavathi.N HR at this organization, towards the fulfillment of award of "Bachelor of Commerce" during the year 2020-2021.

During the period of his internship he has exhibited punctuality and diligence. We wish him every success in his life.

Thanking you,

Yours truly,

  
Leelavathi.N  
HR Manager

  
PRINCIPAL

The National College  
Jayanagar, Bangalore-70.



Ref No: MSPL15052021

Date: 15/05/2021

**TO WHOM IT MAY CONCERN**

To,  
**MS. VANISHREE.M**  
(Interns)

**Sub: Experience Letter**

It is to certify that **MS.Vanishree.M** was working as Interns with us as interns from period **08<sup>th</sup> March, 2021 to 07<sup>th</sup> April 2021** as per the Marketonix's employment record.

During her employment **MS.Vanishree.M** has perused knowledge & experience in our organization.

During her period, we found her to be Professional, knowledgeable and result oriented with theoretical & practical understanding of work requirements.

Overall she performed her duties and responsibilities cheerfully with attention to detail at all times. With her enthusiasm to work, learn and progress, I am certain that she would make a great employee to any enterprise.

For, Marketonix Services Private Limited.

Yours Sincerely,

HR TEAM  
MARKETONIX SERVICES PRIVATE LIMITED



*[Handwritten Signature]*  
PRINCIPAL  
The National College  
Jayanagar, Bangalore-70.





# SHRI VISHKARMA INTERIOR

We undertake *turn key* project of Interiors

Mob : 9008133225

: 9448089049

30, (S.82/1), Jai Hanuman Nagar, Near Divya Jyothi School, Arekere Village, Bannerghatta Road, Bangalore - 560076

## INTERNSHIP CERTIFICATE

This is to certify that **Mr. VENKATESH T** bearing **Register No.18NCJC716**, B.Com final year student, **The National College, Autonomous**, Jayanagar, Bangalore has successfully completed an internship of six weeks (from 04/11/2020 to 18/12/2020) under the guidance of **Mr. UKMARAM – Finance Manager** at this organization, towards the fulfillment of award of “Bachelor of Commerce” during the year 2020 – 2021.

During the period of his internship he has exhibited punctuality and diligence. We wish him every success in life.

For SHRI VISHKARMA INTERIOR

Proprietor/Authorized Signature

Signature and Seal of the company authorized person or head

Date: 21/12/2020

Place: Bengaluru



PRINCIPAL

The National College  
Jayanagar, Bangalore-70.



**Youth for seva™**  
experience the joy of giving



# Certificate of Internship

Dear Vijay Kumar V

from The National College Jayanagar

Youth for Seva congratulates you for your endearing and committed service as an Intern.

Project Employability Skills Mentorship Program

Duration 08/11/2020 to 23/12/2020

Happy Volunteering!

*[Signature]*  
PRINCIPAL  
The National College  
Jayanagar, Bangalore-70.



DATE : December 2020

*[Signature]*  
FOUNDER & EXECUTIVE DIRECTOR

This is certify that Mr. **VINOD KUMAR S** bearing Register No. **18NCJC703**, B.Com final year student, **THE NATIONAL COLLEGE, AUTONOMOUS**, Jayanagar, Bangalore has successfully completed a internship of six weeks (from 14-10-2020 to 28-11-2020) under the guidance of **Mr. GANGA BABU**, Operational Manager at the organization, towards the fulfillment of award of "Bachelor of commerce" during the year 2020-2021.

During the period of him internship he exhibited punctuality and diligence. We wish him every success in life.



Date: 28-11-2020

Place: Bangalore



*[Handwritten Signature]*  
PRINCIPAL  
The National College  
Jayanagar, Bangalore-70.



This is to certify that Mr. VINYAS. B. S bearing Register No. 18NCJC704, B.Com final year student, The National College, Autonomous, Jayanagar, Bangalore has successfully completed a internship of six weeks from 26<sup>th</sup> November 2020 to 28<sup>th</sup> December 2020 under the guidance of Mr. Shridhar – Sole proprietor at this organization, towards the fulfillment of award of "bachelor of commerce" during the year 2020 – 2021.

During the period of his internship, he has exhibited punctuality and diligence.

We wish him every success in life.



Date: 21/01/2021

Place: Bangalore

  
PRINCIPAL  
The National College  
Jayanagar, Bangalore-70.



Ref: GRID / INTERNSHIP/2020

11<sup>th</sup> December, 2020

**TO WHOMSOEVER IT MAY CONCERN**

CERTIFICATE

This is to certify that **A. Vishnu**, Reg No. 18NCJC666, Bcom final year student of The National College, Jayanagar, Autonomous, Jayanagar, Bangalore has successfully completed an Internship of six weeks from 28th Oct 2020 to 11th Dec 2020 under the guidance of Mrs. Vani S.P, HR Administration at "GRID R&D" BANGALORE towards the fulfillment of " Bachelor of Commerce" during the year 2020 - 2021

We found him punctual, agile and efficient.

We wish him prosperity in the posterity.

for GRID R & D

Vani S.P  
HR Administration

PRINCIPAL  
The National College  
Jayanagar, Bangalore-70.





## INTERNSHIP OFFER LETTER

March 10, 2021

Mr. Adithya Parashar K C  
Department of Computer Science,  
National College (Autonomous),  
7<sup>th</sup> Block, Jayanagar, Bengaluru - 70

Dear Adithya Parashar K C,

We would like to congratulate you on being selected for the **Trainee Software Engineer** Internship position with **Renalyx Health Systems Pvt. Ltd, Bengaluru**, effective from March 10, 2021. This internship will be duration of 4 months.

As we discussed during the interview process, this is a non-paid internship.

This internship is viewed by the organization as being an opportunity for you to learn and explore yourself as academic project, rather than a part-time job. As such, your internship will include training/orientation and focus primarily on learning and developing new skills and gaining a deeper understanding of concepts through hands-on application of the knowledge you learned already.

During the internship period you will be accessible for the confidential resources or the documents of the organization. By accepting this offer, you should adhere to the policies and confidentiality of the organization. You are not supposed to disclose any of this confidential resources with the outside world.

You will be working for a project entitled "**Patient disease management system**" and place of work will be in the Bengaluru location. You will be reporting to the head of software team.

You will be issued letter after successful completion of internship. But this letter will not guarantee any employment in Renalyx.

Again, congratulations and we look forward to working with you.

With Best Wishes

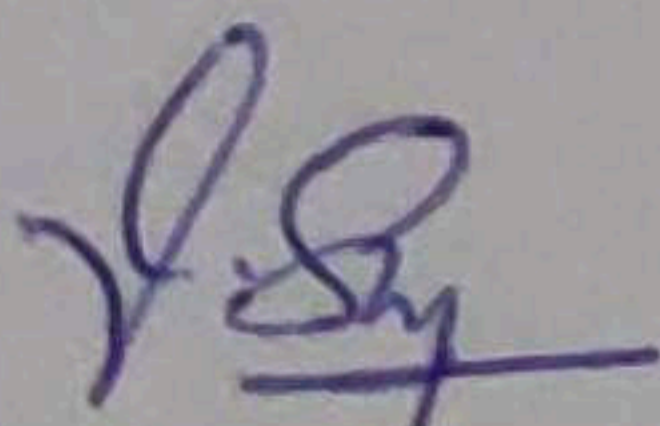

Dr. Shyam Vasudevarao

Director

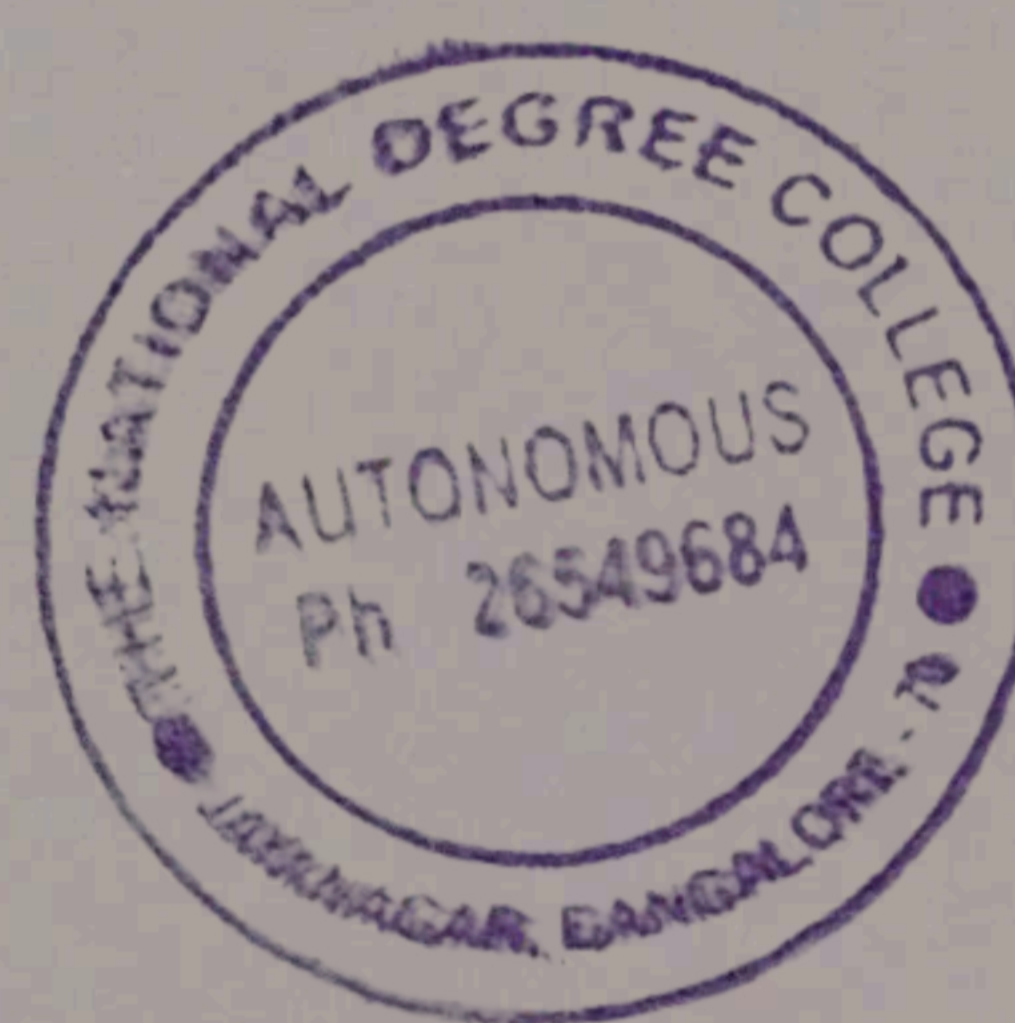

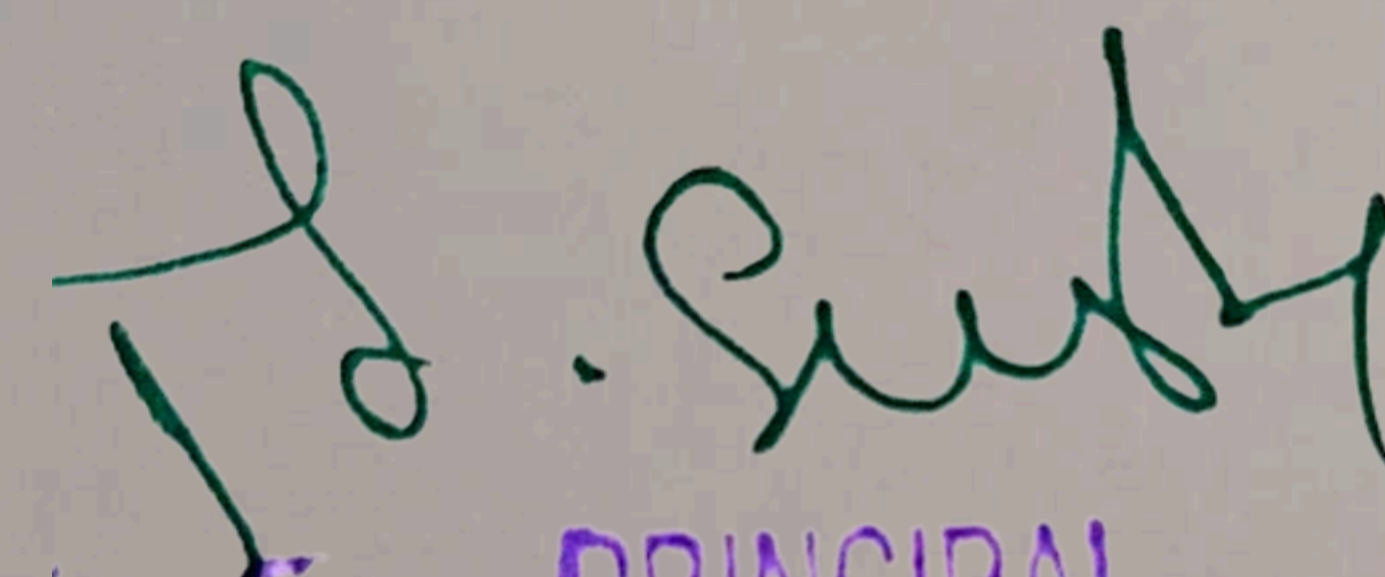
  
PRINCIPAL  
The National College  
Jayanagar, Bangalore-70

**Renalyx Health Systems Private Limited.,**



## INTERNSHIP OFFER LETTER

March 10, 2021

Mr. Karthik  
Department of Computer Science,  
National College (Autonomous),  
7<sup>th</sup> Block, Jayanagar, Bengaluru - 70

Dear Karthik,

We would like to congratulate you on being selected for the **Trainee Software Engineer** Internship position with **Renalyx Health Systems Pvt. Ltd, Bengaluru**, effective from March 10, 2021. This internship will be duration of 4 months.

As we discussed during the interview process, this is a non-paid internship.

This internship is viewed by the organization as being an opportunity for you to learn and explore yourself as academic project, rather than a part-time job. As such, your internship will include training/orientation and focus primarily on learning and developing new skills and gaining a deeper understanding of concepts through hands-on application of the knowledge you learned already.

During the internship period you will be accessible for the confidential resources or the documents of the organization. By accepting this offer, you should adhere to the policies and confidentiality of the organization. You are not supposed to disclose any of this confidential resources with the outside world.

You will be working for a project entitled "**Patient disease management system**" and place of work will be in the Bengaluru location. You will be reporting to the head of software team.

You will be issued letter after successful completion of internship. But this letter will not guarantee any employment in Renalyx.

Again, congratulations and we look forward to working with you.

With Best Wishes

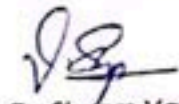

Dr. Shyam Vasudevarao

Director



  
PRINCIPAL  
The National College  
Jayanagar, Bangalore-70.

**Renalyx Health Systems Private Limited.,**

CIN: U74140KA2012PTC066472 | Phone: +91 9380345062. <http://www.renalyx.com>  
No.19, 2<sup>nd</sup> Floor, South End road, Basavanagudi, Bengaluru - 560004 India.

## INTERNSHIP OFFER LETTER

March 10, 2021

Ms. Neha V  
Department of Computer Science,  
National College (Autonomous),  
7th Block, Jayanagar, Bengaluru - 70

Dear Neha V,

We would like to congratulate you on being selected for the **Trainee Software Engineer** Internship position with **Renalyx Health Systems Pvt. Ltd, Bengaluru**, effective from March 10, 2021. This internship will be duration of 4 months.

As we discussed during the interview process, this is a non-paid internship.

This internship is viewed by the organization as being an opportunity for you to learn and explore yourself as academic project, rather than a part-time job. As such, your internship will include training/orientation and focus primarily on learning and developing new skills and gaining a deeper understanding of concepts through hands-on application of the knowledge you learned already.

During the internship period you will be accessible for the confidential resources or the documents of the organization. By accepting this offer, you should adhere to the policies and confidentiality of the organization. You are not supposed to disclose any of this confidential resources with the outside world.

You will be working for a project entitled "**Patient disease management system**" and place of work will be in the Bengaluru location. You will be reporting to the head of software team.

You will be issued letter after successful completion of internship. But this letter will not guarantee any employment in Renalyx.

Again, congratulations and we look forward to working with you.

With Best Wishes



Dr. Shyam Vasudevarao

Director



  
PRINCIPAL  
The National College  
Jayanagar, Bangalore-70.



**Renalyx Health Systems Private Limited.,**



## INTERNSHIP OFFER LETTER

March 10, 2021

Mr. Praneeth M S  
Department of Computer Science,  
National College (Autonomous),  
7<sup>th</sup> Block, Jayanagar, Bengaluru - 70

Dear Praneeth M s,

We would like to congratulate you on being selected for the **Trainee Software Engineer** Internship position with **Renalyx Health Systems Pvt. Ltd, Bengaluru**, effective from March 10, 2021. This internship will be duration of 4 months.

As we discussed during the interview process, this is a non-paid internship.

This internship is viewed by the organization as being an opportunity for you to learn and explore yourself as academic project, rather than a part-time job. As such, your internship will include training/orientation and focus primarily on learning and developing new skills and gaining a deeper understanding of concepts through hands-on application of the knowledge you learned already.

During the internship period you will be accessible for the confidential resources or the documents of the organization. By accepting this offer, you should adhere to the policies and confidentiality of the organization. You are not supposed to disclose any of this confidential resources with the outside world.

You will be working for a project entitled "**Patient disease management system**" and place of work will be in the Bengaluru location. You will be reporting to the head of software team.

You will be issued letter after successful completion of internship. But this letter will not guarantee any employment in Renalyx.

Again, congratulations and we look forward to working with you.

With Best Wishes

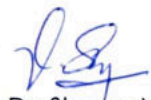

Dr. Shyam Vasudevarao

Director



  
PRINCIPAL  
The National College  
Jayanagar, Bangalore-70.



**Renalyx Health Systems Private Limited.,**



## INTERNSHIP OFFER LETTER

March 10, 2021

Ms. Rakshitha M  
Department of Computer Science,  
National College (Autonomous),  
7<sup>th</sup> Block, Jayanagar, Bengaluru - 70

Dear Rakshitha M,

We would like to congratulate you on being selected for the **Trainee Software Engineer** Internship position with **Renalyx Health Systems Pvt. Ltd, Bengaluru**, effective from March 10, 2021. This internship will be duration of 4 months.

As we discussed during the interview process, this is a non-paid internship.

This internship is viewed by the organization as being an opportunity for you to learn and explore yourself as academic project, rather than a part-time job. As such, your internship will include training/orientation and focus primarily on learning and developing new skills and gaining a deeper understanding of concepts through hands-on application of the knowledge you learned already.

During the internship period you will be accessible for the confidential resources or the documents of the organization. By accepting this offer, you should adhere to the policies and confidentiality of the organization. You are not supposed to disclose any of this confidential resources with the outside world.

You will be working for a project entitled "**Patient disease management system**" and place of work will be in the Bengaluru location. You will be reporting to the head of software team.

You will be issued letter after successful completion of internship. But this letter will not guarantee any employment in Renalyx.

Again, congratulations and we look forward to working with you.

With Best Wishes

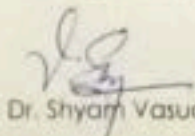

Dr. Shyam Vasudevarao

Director



  
PRINCIPAL  
The National College  
Jayanagar, Bangalore-70.



Renalyx Health Systems Private Limited.

## INTERNSHIP OFFER LETTER

March 10, 2021

Ms Sainirupama  
Department of Computer Science,  
National College (Autonomous),  
7<sup>th</sup> Block, Jayanagar, Bengaluru - 70

Dear Sainirupama,

We would like to congratulate you on being selected for the **Trainee Software Engineer** Internship position with **Renalyx Health Systems Pvt. Ltd, Bengaluru**, effective from March 10, 2021. This internship will be duration of 4 months.

As we discussed during the interview process, this is a non-paid internship.

This internship is viewed by the organization as being an opportunity for you to learn and explore yourself as academic project, rather than a part-time job. As such, your internship will include training/orientation and focus primarily on learning and developing new skills and gaining a deeper understanding of concepts through hands-on application of the knowledge you learned already.

During the internship period you will be accessible for the confidential resources or the documents of the organization. By accepting this offer, you should adhere to the policies and confidentiality of the organization. You are not supposed to disclose any of this confidential resources with the outside world.

You will be working for a project entitled "**Patient disease management system**" and place of work will be in the Bengaluru location. You will be reporting to the head of software team.

You will be issued letter after successful completion of internship. But this letter will not guarantee any employment in Renalyx.

Again, congratulations and we look forward to working with you.

With Best Wishes



Dr. Shyam Vasudevarao

Director



  
PRINCIPAL  
The National College  
Jayanagar, Bangalore-70.



**Renalyx Health Systems Private Limited.,**



# SAPNE

Secure The Childs Future



Date: 09/08/2020

This certificate is presented to: GurunagaNandan. N

For your dedication to your profession in the department  
and for being the "BEST INTERN".

MASS COMMUNICATION

CERTIFICATE  
OF  
APPRECIATION

  
Signature



The National College  
Jayanagar, Bangalore-70.





Jayant Murthy  
The Indian Institute of Astrophysics  
Koramangala  
Bangalore 560034  
India

E-mail: [jmurthy@yahoo.com](mailto:jmurthy@yahoo.com)  
Mobile: (91)9844044228  
Off: (91)(80)25539250x263  
FAX: (91) (80) 25534043  
<http://www.iia.res.in/personnel/murthy/index.htm>

PG coordinator,  
Department of Postgraduate  
studies and research in Physics

Jul 11, 2018

I am pleased to offer a project entitled "Analysis of the ultraviolet sky from spacecraft data" to:

- 1) Mounica K.
- 2) Abishek P.
- 3) Shankar SA

I look forward to working with the students in this exciting project.

Sincerely

*Jayant Murthy*

Jayant Murthy  
Senior Professor

*D. Suresh*

PRINCIPAL  
The National College  
Jayanagar, Bangalore-70.



ಇ/ಮಾ.ಸಂ./ಪರಿಯोजना/2018/ E/HR/Project/2018

25-08-2018

The National College  
BENGALURU.

ಮಹೋದಯ/Dear Sir/ಮಹೋದಯಾ/Madam,

**ವಿಷಯ : ವೇತನ ರಹಿತ ನಿ:ಶುಲ್ಕ ಕೆ ಆಧಾರ ಪರ ಪ್ರಶಿಕೃತಾ ।**

**Sub: Internship on No-Pay-No-Fee-Basis.**

उपर्युक्त विषय पर वेंतन रहित नि:शुल्क के आधार पर M.Sc (Physis) के विद्यार्थी के लिए प्रशिक्षुता हेतु अनुरोध करते हुए आपके द्वारा भेजा गया पत्र का कृपया संदर्भ लें ।

Reference is made to your letter on the above subject, requesting for Internship to the student/s of M.Sc (Physis) on No-Pay-No-Fee-Basis in our organization.

2. निम्नांकित विद्यार्थियों को प्रयोगशाला, इंजन प्रभाग, एचएएन (बीसी), बेंगलूरु-93 में दिनांक 03-09-2018 से 01-10-2018 तक प्रशिक्षुता हेतु स्वीकृति प्रदान की जाती है, बशर्त निम्नानुसार ही.

We are pleased to accept the following student/s for Internship in Laboratory, Engine Division, HAL (BC), Bangalore-93 from 03-09-2018 से 01-10-2018 subject to the Terms & Conditions mentioned below:-

क्र.सं. Sl No	विद्यार्थी का नाम Name of the student/s (M/s)
1	Bharathi V
2	Deepa N

कोई भी स्थिति में परियोजना कार्य/इनप्लांट प्रशिक्षण/वेंतन रहित नि:शुल्क के आधार पर प्रशिक्षुता की अवधि में बढ़ोतरी या तिथि में बदलाव पर विचार नहीं किया जाएगा ।

Request or further extension of tenure / Change of dates for Project Work / In-plant-training/ Internship on No - Pay No Fee - basis will not be considered under any circumstances.

**निबंध एवं शर्त / Terms and Conditions :-**

- प्रशिक्षण खासकर वेंतन रहित नि:शुल्क के आधार पर होगा;  
The training is purely on No-Pay-No-Fee-Basis;
- संस्थान के प्रामाणिक विद्यार्थी/विद्यार्थियों को सिफारिश करना चाहिए;  
Only Bonafide student(s) of the institution should be sponsored;
- विद्यार्थी/विद्यार्थियों अध्ययन के अंतिम वर्ष के पूर्व वर्ष / अंतिम वर्ष में होना चाहिए;  
The student(s) should be in their pre-final / final year of studies;
- विद्यार्थी/विद्यार्थियों भारत के नागरिक होना चाहिए;  
The student(s) should be of Indian Nationality;
- विद्यार्थी/विद्यार्थियों, कंपनी के नियम-विनियमों को सख्ती से पालन करना चाहिए;  
The student(s) will strictly abide by the rules & regulations of the Company;

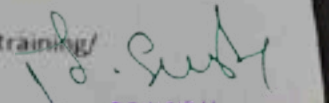
  
PRINCIPAL  
The National College  
Javanagar, Bangalore-70





Page 1 - 3



ಇ/ಮಾ.ಸಂ./ಪರಿಷ್ಕರಣೆ/2018/ E/HR/Project/2018

25-08-2018

The National College  
BENGALURU.

ಮಹೋದಯ/Dear Sir/ಮಹೋದಯ/Madam,

**ವಿಷಯ : ವೇತನ ರಹಿತ ನಿ:ಶುಲ್ಕ ಕೆ ಆಧಾರ ಪರ ಪ್ರಶಿಕೃತಾ ।**

**Sub: Internship on No-Pay-No-Fee-Basis.**

उपर्युक्त विषय पर वेंतन रहित नि:शुल्क के आधार पर M.Sc ( Physis) के विद्यार्थी के लिए प्रशिक्षुता हेतु अनुरोध करते हुए आपके द्वारा भेजा गया पत्र का कृपया संदर्भ लें ।

Reference is made to your letter on the above subject, requesting for Internship to the student/s of M.Sc (Physis) on No-Pay-No-Fee-Basis in our organization.

2. निम्नांकित विद्यार्थियों को प्रयोगशाला, इंजन प्रभाग, एचएएन (बीसी), बेंगलूरु-93 में दिनांक 03-09-2018 से 01-10-2018 तक प्रशिक्षुता हेतु स्वीकृति प्रदान की जाती है, बशर्त निम्नानुसार ही.

We are pleased to accept the following student/s for Internship in Laboratory, Engine Division, HAL (BC), Bangalore-93 from 03-09-2018 से 01-10-2018 subject to the Terms & Conditions mentioned below:-

क्र.सं. Sl No	विद्यार्थी का नाम Name of the student/s (M/s)
1	Bharathi V
2	Deepa N

—कोई भी स्थिति में परियोजना कार्य/इन्प्लांट प्रशिक्षण/वेंतन रहित नि:शुल्क के आधार पर प्रशिक्षुता की अवधि में बढ़ोतरी या तिथि में बदलाव पर विचार नहीं किया जाएगा ।

Request or further extension of tenure / Change of dates for Project Work / In-plant-training/ Internship on No - Pay No Fee - basis will not be considered under any circumstances.

**निबंध एवं शर्त / Terms and Conditions :-**

- प्रशिक्षण खासकर वेंतन रहित नि:शुल्क के आधार पर होगा;  
The training is purely on No-Pay-No-Fee-Basis;
- संस्थान के प्रामाणिक विद्यार्थी/विद्यार्थियों को सिफारिश करना चाहिए;  
Only Bonafide student(s) of the institution should be sponsored;
- विद्यार्थी/विद्यार्थियों अध्ययन के अंतिम वर्ष के पूर्व वर्ष / अंतिम वर्ष में होना चाहिए;  
The student(s) should be in their pre-final / final year of studies;
- विद्यार्थी/विद्यार्थियों भारत के नागरिक होना चाहिए;  
The student(s) should be of Indian Nationality;
- विद्यार्थी/विद्यार्थियों, कंपनी के नियम-विनियमों को सख्ती से पालन करना चाहिए;  
The student(s) will strictly abide by the rules & regulations of the Company;

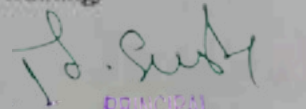
  
PRINCIPAL  
The National College  
Javanagay, Bangalore-70





Page 1 - 3

ಬೆಂಗಳೂರು ಕಛೇರಿ : ೧೫/೧, ಕಬ್ಬನ್ ರೋಡ್, ಬೆಂಗಳೂರು - ೫೬೦ ೦೦೧, ಭಾರತ

पंजीकृत कार्यालय : 15/1, कब्यन रोड, बेंगलूरु - 560 001, भारत

Registered Office : 15/1, Cubbon Road, Bengaluru - 560 001, India

CIN : U35301KA1963GO1001622





**JAWAHARLAL NEHRU PLANETARIUM**  
**BANGALORE ASSOCIATION FOR SCIENCE EDUCATION**  
(A Registered Society of the Government of Karnataka)

Date: 13<sup>th</sup> November 2019

To,  
The Coordinator  
Department of Physics (P.G)  
National College (Autonomous)  
Jayanagar, Bengaluru-70.

Sir,

**Subject:** Acceptance to supervise M.Sc. (physics) project

As you may know that the students listed below approached me and requested to suggest and supervise a project in Astronomy. As per the discussion with students I have agreed to supervise their project "Scope and relevance of UV telescopes".

List of students

- 1) Ms. Sushmitha N S
- 2) Ms. Sushmitha S
- 3) Mr. Manju Vasanth Maladkar
- 4) Mr. Sharath Kumar T.S.

Thanking you

*[Handwritten Signature]*  
PRINCIPAL

The National College  
Jayanagar, Bangalore-70

Yours Sincerely

*[Handwritten Signature]*





Jayant Murthy  
The Indian Institute of Astrophysics  
Koramangala  
Bangalore 560034  
India

E-mail: [jmurthy@yahoo.com](mailto:jmurthy@yahoo.com)  
Mobile: (91)9844044228  
Off: (91)(80)25539250x263  
FAX: (91) (80) 25534043  
<http://www.iiaa.res.in/personnel/murthy/index.htm>

PG coordinator,  
Department of Postgraduate  
studies and research in Physics

Jul 11, 2018

I am pleased to offer a project entitled "Analysis of the ultraviolet sky from spacecraft data" to:

- 1) Mounica K.
- 2) Abishek P.
- 3) Shankar SA

I look forward to working with the students in this exciting project.

Sincerely

*Jayant Murthy*

Jayant Murthy  
Senior Professor

*D. Sudh*

PRINCIPAL  
The National College  
Jayanagar, Bangalore-70.





ಶಿಕ್ಷಣದ ಮೂಲಕ ಸಂಪನ್ಮೂಲ

## Declaration

L NAGENDRA PRASAD B.K [17NCJPP017] declare that, to the best of my conscience the project entitled "Fabrication and Performance Evaluation of Thin film Inductor" was performed by me, under the guidance of Dr. K R Gunasekhar, Principal Research Scientist, Department of Instrumentation and Applied Physics, Indian Institute of Science, Bengaluru - 560012. The work has not been submitted in substance before for any degree.

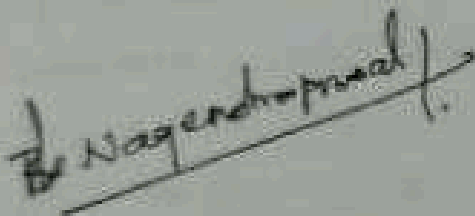

NAGENDRA PRASAD B.K

[17NCJPP017]

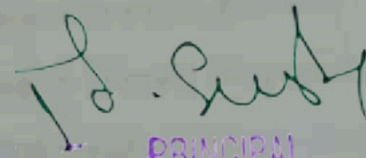

PRINCIPAL

The National Degree College  
Jayanagar, Bangalore-70.



  
Dr. K. R. Gunasekhar

Principal Research Scientist

Department of Instrumentation and Applied Physics

Indian Institute of Science, Bengaluru

Dr. K.R. GUNASEKHAR  
Principal Research Scientist  
Dept. Of Instrumentation & Applied Physics  
Indian Institute of Science  
Bangalore - 560 012, India.  
Ph : 080-22933194, E-mail : krguna@iisc.ac.in





Jayant Murthy  
The Indian Institute of Astrophysics  
Koramangala  
Bangalore 560034  
India

E-mail: [jmurthy@yahoo.com](mailto:jmurthy@yahoo.com)  
Mobile: (91)9844044228  
Off: (91)(80)25539250x263  
FAX: (91) (80) 25534043  
<http://www.iiap.res.in/personnel/murthy/index.htm>

PG coordinator,  
Department of Postgraduate  
studies and research in Physics

Jul 11, 2018

I am pleased to offer a project entitled "Analysis of the ultraviolet sky from spacecraft data" to:

- 1) Mounica K.
- 2) Abishek P.
- 3) Shankar SA

I look forward to working with the students in this exciting project.

Sincerely

*Jayant Murthy*

Jayant Murthy  
Senior Professor

*T. S. Sush*

PRINCIPAL  
The National College  
Jayanagar, Bangalore-70.





**JAWAHARLAL NEHRU PLANETARIUM**  
**BANGALORE ASSOCIATION FOR SCIENCE EDUCATION**  
(A Registered Society of the Government of Karnataka)

Date: 13<sup>th</sup> November 2019

To,  
The Coordinator  
Department of Physics (P.G)  
National College (Autonomous)  
Jayanagar, Bengaluru-70.

Sir,

**Subject:** Acceptance to supervise M.Sc. (physics) project

As you may know that the students listed below approached me and requested to suggest and supervise a project in Astronomy. As per the discussion with students I have agreed to supervise their project "Scope and relevance of UV telescopes".

List of students

- 1) Ms. Sushmitha N S
- 2) Ms. Sushmitha S
- 3) Mr. Manju Vasanth Maladkar
- 4) Mr. Sharath Kumar T.S.

Thanking you

Yours Sincerely



PRINCIPAL  
The National College  
Jayanagar, Bangalore-70



**JAWAHARLAL NEHRU PLANETARIUM**  
**BANGALORE ASSOCIATION FOR SCIENCE EDUCATION**  
(A Registered Society of the Government of Karnataka)

Date: 13<sup>th</sup> November 2019

To,  
The Coordinator  
Department of Physics (P.G)  
National College (Autonomous)  
Jayanagar, Bengaluru-70.

Sir,

**Subject:** Acceptance to supervise M.Sc. (physics) project

As you may know that the students listed below approached me and requested to suggest and supervise a project in Astronomy. As per the discussion with students I have agreed to supervise their project "Scope and relevance of UV telescopes".

List of students

- 1) Ms. Sushmitha N S
- 2) Ms. Sushmitha S
- 3) Mr. Manju Vasanth Maladkar
- 4) Mr. Sharath Kumar T.S.

Thanking you

Yours Sincerely



PRINCIPAL  
The National College  
Jayanagar, Bangalore-70





**JAWAHARLAL NEHRU PLANETARIUM**  
**BANGALORE ASSOCIATION FOR SCIENCE EDUCATION**  
(A Registered Society of the Government of Karnataka)

Date: 13<sup>th</sup> November 2019

To,  
The Coordinator  
Department of Physics (P.G)  
National College (Autonomous)  
Jayanagar, Bengaluru-70.

Sir,

**Subject:** Acceptance to supervise M.Sc. (physics) project

As you may know that the students listed below approached me and requested to suggest and supervise a project in Astronomy. As per the discussion with students I have agreed to supervise their project "Scope and relevance of UV telescopes".

List of students

- 1) Ms. Sushmitha N S
- 2) Ms. Sushmitha S
- 3) Mr. Manju Vasanth Maladkar
- 4) Mr. Sharath Kumar T.S.

Thanking you

Yours Sincerely



PRINCIPAL  
The National College  
Jayanagar, Bangalore-70

**Dr. K. Gopukumar, PhD**  
Consultant Neuropsychologist





**BENGALURU  
NEURO CENTRE**

19<sup>th</sup> March, 2021  
Bangalore.

**TO WHOMSOEVER IT MAY CONCERN**

This is to certify that Ms. Dhriti P Desai, a student of II-year BA., Psychology, National College, Jayanagar, Bangalore, has successfully completed one week [from 13<sup>st</sup> March to 19<sup>th</sup> March 2021] observership at Neuropsychology Unit, Bangalore Neuro Centre, Bangalore. During the period of her observership, she observed, IQ assessment Neuropsychological Assessment (Children & Adult), Counselling, Cognitive Behaviour therapy, relaxation therapy (JPMR & Benson's), cognitive re-training sessions, case discussion and, other therapy sessions. She was found to be sincere, hardworking, and motivated. She worked well as part of the team during her tenure. We take this opportunity to thank her and wish her all the best.

  
Dr. Gopukumar Kumarpillai, Ph.D., Post Doc.,  
Neuropsychologist  
Bangalore Neuro Centre,  
10<sup>th</sup> Cross, Malleshwaram,  
Bangalore – 560003.

  
PRINCIPAL  
The National College  
Jayanagar, Bangalore-70.



**Bengaluru Neuro Center Pvt. Ltd**  
# 27/5, 10th Cross, 3rd Main  
Margosa Road, Malleshwaram

Scanned By Scanner Go





**LITTLE BLUEJAYS CARE PVT LTD**

Little Bluejays  
Specialized Care for Children with Special Needs

Dear sir/ Madam

This is to certify that Miss.Nayana Thara.R student of Psychology from National College attended Little Bluejays care Pvt Ltd for internship program from 1<sup>st</sup> June to 25th June 2018. During her internship period she has observed the Early Intervention services given to the kids with Autism, ADHD, Intellectual Deficit, and Genetic Disorder. The center works with the Interdisciplinary Model where they provide Behaviour Modification therapy, Cognitive Behavior Therapy, Occupational Therapy, Physiotherapy, Speech therapy and Special education. The center also provides Screening, Consultation and Assessment depending on the need of the child condition for which detailed report is issued.

She has observed the whole process and therapies conducted in the center. She has submitted one detailed case history report and case summary reports of the clients which she has observed. During the intemship period she has shown immense interest and genuine willingness to learn, and zeal to take new assignments given to her.

We wish Nayana Thara.R all the very best for her future.

*Kruthika.V*

Warm Regards

Kruthika.V

Msc Clinical Psychology

Little Bluejays Care Pvt Ltd.

*D. Sudh*

PRINCIPAL

The National Collage  
Jayanzgar, Bangalore-70.



**Psychologist  
Little Blue Jays Care**



# SPANDANA HEALTH CARE

No.236/2, 29th Main, 5th Block, Nandini Layout, (Coconut Garden), Near Ring Road Bridge,  
Bangalore - 560 096. Phone : 23595652 / 9035560000 / 9036680000  
CIN - U05110KA2004PTC034140

Ref:

Date: 16/12/2019

This is to state that **Mr. Prajwal Raghavendra. R.** (Roll no: 17NCJA046) student of third year B.A Psychology Programme, at **The National College**, Bangalore, had attended his internship programme, from December 06<sup>th</sup> 2019 to December 20<sup>th</sup> 2019 at **Spandana Health Care**, Nandini Layout, Bangalore.

During his tenure as an intern at Spandana Health Care, he was actively involved in observing clinical interviews and assessments carried out for patients at the hospital. Also, he participated in various activities at the hospital such as group counselling sessions, psychoeducational activities and individual/group supervision hours for interns at the hospital. He showed his interest in learning/understanding various mental health disorders and was consistent in completing the assigned tasks of the internship programme.

We wish him all the success for his future endeavours.

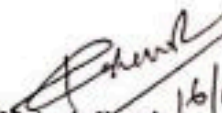
  
Dr Mahesh Gowda  
Managing Director  
Spandana Health Care

16/12/19

**SPANDANA HEALTH CARE**  
Sy. No. 236/2, 29th Main, 5th Block,  
Nandini Layout, (Coconut Garden)  
Near Ring Road, Bridge, Bangalore-06

  
PRINCIPAL  
The National College  
Jayanagar, Bangalore-70



*Committed to Mental Health Care*



Dr. K. Gopukumar, PhD  
Consultant Neuropsychologist





## BENGALURU NEURO CENTRE

19<sup>th</sup> March, 2021  
Bangalore.

### TO WHOMSOEVER IT MAY CONCERN

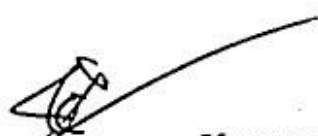
This is to certify that Ms. Shilpa B, a student of II-year B.A., Psychology, National College, Jayanagar, Bangalore, has successfully completed one week [from 13<sup>st</sup> March to 19<sup>th</sup> March 2021] observership at Neuropsychology Unit, Bangalore Neuro Centre, Bangalore. During the period of her observership, she observed, IQ assessment Neuropsychological Assessment (Children & Adult), Counselling, Cognitive Behaviour therapy, relaxation therapy (JPMR & Benson's), cognitive re-training sessions, case discussion and, other therapy sessions. She was found to be sincere, hardworking, and motivated. She worked well as part of the team during her tenure. We take this opportunity to thank her and wish her all the best.

  
Dr. Gopukumar Kumarpillai, Ph.D., Post Doc.,  
Neuropsychologist  
Bangalore Neuro Centre,  
10<sup>th</sup> Cross, Malleshwaram,  
Bangalore - 560003.

  
PRINCIPAL  
The National College  
Jayanagar, Bangalore-70.

Bengaluru Neuro Center Pvt. Ltd  
# 27/5, 10th Cross, 3rd Main  
Margosa Road, Malleshwaram,  
Bangalore-560 003





Dr. K. Gopukumar, Ph.D  
Consultant Neuropsychologist



BENGALURU  
NEURO CENTRE

19<sup>th</sup> March, 2021  
Bangalore.

**TO WHOMSOEVER IT MAY CONCERN**

This is to certify that Ms. Srushti jagadish, a student of II-year BA., Psychology, National College, Jayanagar, Bangalore, has successfully completed one week [from 13<sup>st</sup> March to 19<sup>th</sup> March 2021] observership at Neuropsychology Unit, Bangalore Neuro Centre, Bangalore. During the period of her observership, she observed, IQ assessment Neuropsychological Assessment (Children & Adult), Counselling, Cognitive Behaviour therapy, relaxation therapy (JPMR & Benson's), cognitive re-training sessions, case discussion and, other therapy sessions. She was found to be sincere, hardworking, and motivated. She worked well as part of the team during her tenure. We take this opportunity to thank her and wish her all the best.

  
Dr. Gopukumar Kumarpillai, Ph.D., Post Doc.,  
Neuropsychologist  
Bangalore Neuro Centre,  
10<sup>th</sup> Cross, Malleshwaram,  
Bangalore - 560003.

Bengaluru Neuro Center Pvt. Ltd  
# 27/5, 10th Cross, 3rd Main  
Margosa Road, Malleshwaram  
Bangalore-560 003

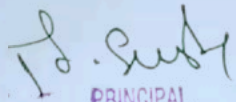
  
PRINCIPAL  
The National College  
Jayanagar, Bangalore-70.





**THE NATIONAL COLLEGE**  
**Autonomous**  
**Jayanagar, Bangalore-560070**

**CERTIFICATE**

This is to certify that the project report titled " Dell " is a bonafide record of work done by **CHAITRA S (19NCJS342)** of **THE NATIONAL COLLEGE**, Jayanagar, Bangalore, in partial fulfilment of the requirements of **IV Semester B.SC [BME]** during the year **2020-2021**.

**HEAD OF THE DEPARTMENT**

**PROJECT GUIDE**

DATE OF EXAMINATION:

STUDENT SIGNATURE:

Chaitra S

**PRINCIPAL**  
**The National College**  
**Jayanagar, Bangalore-70**

**Head, Dept of English**  
**The National Degree College**  
**(Autonomous) 7th Block**  
**Jayanagar, Bangalore - 70**





|| ಪ್ರವೃತ್ತಿ ಪರಮಾ ಗತಿ: ||

**THE NATIONAL COLLEGE**  
Autonomous  
Jayanagar, Bangalore-560070

**CERTIFICATE**

This is to certify that the project report on "RESEARCH OF A COMPANY" titled "WIPRO LIMITED" is a Bonafede record of work done by SPOORTHI H YAVAGAL (19NCJS343) of THE NATIONAL COLLEGE, Jayanagar, Bangalore, in partial fulfilment of the requirements of IV Semester BSc. [Bio- Medical Electronics], TECHNICAL ENGLISH during the year 2020-2021.

STUDENT SIGNATURE:

*Spoorthi*

PROJECT GUIDE:

*[Signature]*

HEAD OF THE DEPARTMENT:

*[Signature]*

*[Signature]*

PRINCIPAL  
The National College  
Jayanagar, Bangalore-70.

Head, Dept of English  
The National College  
(Autonomous) 7th Block  
Jayanagar, Bangalore - 70.





Dated, 7th December 2020

**TO WHOMSOEVER IT MAY CONCERN**

This is to certify that **Mr. ADARSH N** bearing Register No. **18NCJC668** , B.Com final year student, **The National College, Autonomous, Jayanagar, Bangalore** has successfully completed a internship of six weeks (from 24-10-2020 to 05-12-2020 ) under the guidance of **H. THIMMARAJU. BE. CIVIL** (Name & Designation – Department) at this organization, towards the fulfillment of award of “Bachelor of Commerce” during the year 2020 – 2021.

During the period of his internship he has exhibited punctuality and diligence.

We wish him every success in life.

Thanking You,

for DISHA ENGINEERING.,

For DISHA ENGINEERING



Proprietor



PRINCIPAL  
The National College  
Jayanagar, Bangalore-70.





# G.M. GROUP OF INDUSTRIES

A UNIT OF PRINTING AND PACKAGING  
Mfrs. Of corrugated boxes, printing cartons, E-Flute cartons

+919844341931

+917353989828

DATE : 5<sup>th</sup> December 2020

## CERTIFICATE

This is to certify that **MS. Aishwarya Melmari (REG NO: 18NCJC602) BCOM** student of **THE NATIONAL COLLEGE JAYANAGARA, BANGLORE** has undergone internship for a period from **27<sup>th</sup> October to 5<sup>th</sup> December 2020** in our GM Group of Industries , Bangalore under guidance of Soumya A J-HR Executive.

During the above period the performance and conduct of **MS Aishwarya Melmari** has been satisfactory.

For Gm Group Of Industries



Narayanaswamy B.G

PROPRIETER

  
PRINCIPAL  
The National College  
Jayanagar, Bangalore-70.



To whomsoever this may concern

This is to certify that Ms. Aishwarya S. bearing Register No. 18NCJC706, B. Com final year student, The National College, Autonomous, Jayanagar, Bangalore has successfully completed an internship of six weeks (from 7 October 2020 to 30 November 2020) under the guidance of A. N. Venkatesh, Financial Controller & Company Secretary at this organisation, towards the fulfilment of award of "Bachelor of Commerce" degree during the year 2020-2021.

During the period of her internship she has exhibited punctuality and diligence. We wish her every success in life.

For Nordson India Private Limited

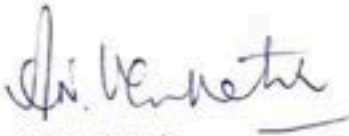

**A N Venkatesh**  
Financial Controller & Company Secretary



**PRINCIPAL**  
The National College  
Jayanagar, Bangalore-70.



Date: 1 December 2020

Place: Bangalore



To,  
Mr. Arun Kumar,  
HOD- Dept. of Commerce,  
The National College, Jayanagar,  
Bengaluru-560070.

**Sub : Letter of Internship acceptance**

This is to certify that **Mr. Akash** pursuing his B.com in **The National College (Autonomous) Jayanagar, Bengaluru-560070**, he has started his internship in our firm from **1st March 2021**.

Area of Specification :

**Gathering & Analyzing Information,  
Event Management, Digital Marketing, etc**

**Mr. Akash** is guided by **Mr. Venkata Sainath** Assistant Project Manager.  
He will complete his Internship by **30th March 2021**.



*[Handwritten Signature]*  
**PRINCIPAL**  
**The National College**  
**Jayanagar, Bangalore-70.**

For VARADA INNOVATIONS

*[Handwritten Signature]*  
**Venkata Sainath**  
Proprietor  
Manager



# VSS INNOVATIVE TECHNOLOGIES

For enquiry Call : 77958 51053 / 88928 49980

## TO WHOM IT MAY CONCERN

This is to certify that **Mr. AKASH ADIGA B** bearing Register No. **18NCJC603** student of B.com Final Year, The National College (Autonomous), Jayanagar, Bangalore worked as an intern at VSS Innovative Technologies, Bangalore from 16 November 2020 to 31 December 2020 on the internship program titled **Bachelor of Commerce**. During the tenure here, he worked hard and delivered the assigned work at the stipulated time. VSS Innovative Technologies wishes all success in his career.

VSS Innovative Technologies



Authorized Signatory

  
PRINCIPAL  
The National College  
Jayanagar, Bangalore-70.



BTM : #676, 29th Main, BTM Layout, 2nd Stage, Bangalore - 560 076.

Marathahalli : #505/1, Aswatha Nagar, Opp.Max Show Room Old Airport Road, Near Marathahalli Bridge - 37.

E-mail : vsstek@gmail.com web : www.vsstech.in

Timings : Monday - Sunday 7.30 am to 7.50pm

This is to certify that **Mr. ANUP P** bearing **Register No. 18NCJC669**, B. Com final year student, **The National College, Autonomous**, Jayanagar, Bangalore has successfully completed internship of six weeks (*from 05/11/2020 to 19/12/2020*) under the guidance of **Mr. Gurudeva, Accountant** at the organization, towards the fulfillment of award of "Bachelor of Commerce" during the year 2020-2021.

During the period of his internship, he exhibited punctuality and diligence. We wish him every success in life.

For EAZYWAY CORPORATE CONSULTING PVT LTD

*O. Suneel Kumar*  
Director/ Authorized Signatory  
Signature

Date: 19-12-2020

Place: Bangalore



*S. Sush*  
PRINCIPAL  
The National College  
Jayanagar, Bangalore-70



Date: 04-08-2021

**INTERNSHIP COMPLETION CERTIFICATE**

This is to certify that **Mr.Arjun.M** being registered No.18NCJC671 has completed the internship of 45 days in our organisation M/s.Stayfit Health & Fitness World Pvt Ltd in Accounts & Finance Department under the guidance of Mr.Narasimha Reddy ( Manager - Accounts & Finance ).

For Stayfit Health &amp; Fitness World Pvt Ltd



  
PRINCIPAL  
The National College  
Jayanagar, Bangalore-70.



**STAYFIT HEALTH AND FITNESS WORLD PRIVATE LIMITED (SPL)**  
STAYFIT TOWERS # 580, 11th Main, 36th Cross, 5th Block, Jayanagar, Bangalore-41. INDIA

*Exercise for healthy living*

Corporate Office:

Tel: 080 4121 3333, 4080 0000

Toll Free No. 1800 102 9000

E-stayfit@stayfitindia.com

www.stayfitindia.com

www.stayfitmagazine.com



# Powernet Solutions Pvt Ltd.

No. 7&8, Jalaram Industrial Estate, Arekere Gate,  
Bannerghatta Road, Bangalore - 560 076  
Tele : 080-2648 7741 / 2648 7761  
CIN : U31909KA1999PTC025040  
GST No. : 29AABCP7283Q1Z1

## CERTIFICATE

This is to certify that Ms. ARPITHA.V bearing Register No. 18NCJC605, B.Com final year student, The National College, Autonomous, Jayanagar, Bangalore has successfully completed a internship of six weeks *from 12-10-2020 to 21-11-2020* under the guidance of SANDEEP GOWDA, Accountant, Accounts Department at this organization, towards the fulfillment of award of "Bachelor of Commerce" during the year 2020 - 2021.

During the period of her internship she has exhibited punctuality and diligence.

We wish her every success in life.

OF POWERNET SOLUTIONS PVT. LTD

*T. S. Bhageerathi*  
DIRECTOR

Signature

Date: 23-11-2020.



*T. S. Subh*  
PRINCIPAL  
The National College  
Jayanagar, Bangalore-70.



8<sup>th</sup> January 2021

## CERTIFICATE OF INTERNSHIP

This is to certify that Ms. Ashwini.V bearing Reg No: 18NCJC672, B.com final year student, the National college, Autonomous, jayanagar, Bangalore has successfully completed her internship of six weeks from 05<sup>th</sup> November 2020 to 30<sup>th</sup> December 2020 under the guidance of preethi (HR department) in our organization, towards the fulfillment of award of "Bachelor of commerce" during the year 2020-2021

During the period of her internship, she has exhibited punctuality and diligence.

We wish her every success in life.

Thanks & Regards



Director- Admin & Technical

  
PRINCIPAL  
The National College  
Jayanagar, Bangalore-70.







**ಭಾರತ ಎಲೆಕ್ಟ್ರಾನಿಕ್ಸ್**  
**भारत इलेक्ट्रॉनिक्स**  
**BHARAT ELECTRONICS**

**भारत इलेक्ट्रॉनिक्स लिमिटेड**

(भारत सरकार का उद्यम, रक्षा मंत्रालय)  
उत्पाद विकास एवम् नवोन्मेष केंद्र  
जालहल्ली पोस्ट, बेंगलूरु-560 013, भारत

**BHARAT ELECTRONICS LIMITED**  
(A Govt. of India Enterprise, Ministry of Defence)  
**Product Development & Innovation Centre**  
Jalahalli Post, Bengaluru-560 013, India.

फोन / Phone :

फैक्स / Fax :

ईमेल / E-mail :

सं/No: 6050/HR/PDIC/PT-110/2020-21

दिनांक/Date: 10.12.2020

**(उत्पाद विकास ए नवोन्मेष केंद्र)**  
**PRODUCT DEVELOPMENT INNOVATION CENTRE**

**प्रमाण-पत्र - CERTIFICATE**

This is to certify that Mr. Chandan Mallu R, Register No. 18NCJC606, student of the The National College, Autonomous, Jayanagar Bangalore has undergone Internship in BEL Six weeks (from 27.10.2020 to 10.12.2020) and has undergone Orientation in "PDIC/Finance".

He was regular and punctual and his conduct was satisfactory during period.

*Thimmaiah*  
**SR./ASST. HR OFFICER**  
**(HR)/PDIC**

ಶಿರೇಮ ಥಿಮಾiah / THIMMAIAH K M  
206140

ವಿಂಚ ಸಹಾಯಕ ಹು ಸ ಅಧಿಕಾರಿ  
SR. ASST. H R OFFICER  
ಽ ವಿ ಥ ನ ಕೆ / PD & IC



*Chandan Mallu R*  
**PRINCIPAL**  
**The National College**  
**Jayanagar, Bangalore-70.**

## CERTIFICATE

### TO WHOM SO EVER IT MAY CONCERN

This is to certify that **Mr. CHETHAN.V** (REG: 18NCJC673) from NATIONAL COLLEGE ,JAYANAGAR BANGLORE, he has successfully completed his Internship/Project training starting from **05-10-2020 to 25-11-2020[45 days]** the project titled **“STUDY ON CASHFLOW STATEMENT AT PRABHUDAS LILLADHER PVT LTD, Bangalore”**.

On completion of the project, he has submitted a report of the above studies.

We wish all the best for his future Endeavour's.

DATE: 05/12/2020

PLACE: BANGALORE

  
SIGNATURE



  
PRINCIPAL  
The National College  
Jayanagar, Bangalore-70.



**Prabhudas Lilladher Pvt. Ltd.**

Regd Office: 3rd Floor, Sadhana House, 5/70, P.B.Marg, Worli, Mumbai - 400 018 | Tel. + 91 22 6632 2222 | Fax. + 91 22 6632 2229  
CIN: U67199MH1983PTC029670 Compliance Officer: **Mr. A. Subrahmanian** | Email: asubrahmanian@plindia.com

SEBI REGN No - BSE (Cash/F&O) INB/F 010502855, NSE (Cash/F&O/Currency Derivatives) INB/F/E 230597738  
CDSL IN DP CDSL 14/99, DP ID 12011390, NSDL IN DP NSDL 329 2010, DP ID IN303868, PMS INP000001231, AMFI ARN 3276

Dated 21 December 2020

**INTERNSHIP COMPLETION LETTER**

This is certify that Mr **DEEPAK G** bearing register No **18ncjc674** B.com final year student. **THENATIONAL COLLEGE, AUTONOMOUS** Jayanagara, Bangalore has successfully completed internshipOf six weeks (from 9-11-2020 to 19-12-2020) Under the guidance of **MR RAHUL** Exide life InsuranceRelationship Manger at the organization towards the fulfilment of award of Bachelor of CommerceDuring the year 2020-2021.

During the period of him internship he exhibited punctuality and diligence.We wish him every success in life.

*Rahul Nimane*

Exide Life Insurance Company Limited  
3rd Floor, JP Techno Park  
No. 3/1, Millers Road  
Bengaluru - 560 001

Registered Office

Exide Life Insurance company  
BMR Sankeerna, No 18, 1<sup>st</sup> Cross, 6<sup>th</sup> Main, MICO Layout  
BTM 2<sup>nd</sup> Stage, Bangalore 560076, India

*D. Sudh*  
PRINCIPAL  
The National College  
Jayanagar, Bangalore-70





CHETAN ENTERPRISES  
#56, Near Bus stop, Devarachikknahalli,  
Bangalore-560076



CHETAN ENTERPRISES

This is to certify that **Mr.Dhanush D S** bearing register number **18NCJC718 B.com** final year student , **The National College, Autonomous, Jayanagar, Bangalore** has successfully completed internship of seven weeks (from **07/11/2020** to **22/12/2020**) under the guidance of **Mr.Chetan C V**, proprietor of the enterprise, towards the fulfilment of award of "Bachelor of commerce" during the year 2020-2021.

Signature and Seal of the company authorized person or head

For CHETAN ENTERPRISES

*Chetan C V*  
Proprietor

Date: 18/03/2021  
Place: Bangalore

*D. Sush*  
PRINCIPAL  
The National College  
Jayanagar, Bangalore-70.





# KNND ASSOCIATES PVT. LTD.

This is to certify that **Mr. DURGAPRASAD K. C** bearing *Register No. 18NCJC675* B. Com final year student, **The National College, Autonomous**, Jayanagar, Bangalore has successfully completed an internship of six weeks (*from 05-10-2020 to 18-11-2020*) under the guidance of **N. P. RAVISHANKAR** (**Accounts and Finance Manager**) at this organization, towards the fulfillment of award of "Bachelor of Commerce" during the year 2020 –2021.

During the period of his internship he has exhibited punctuality and diligence.  
We wish him every success in life.

For KNND ASSOCIATES PVT. LTD.

*N.P. Ravishankar*  
Authorized Signatory

Signature and Seal of the company authorized person or head  
(Optional – with Name and Designation of signed person)

Date: 21.11.2020  
Place: Bangalore

*T. Sushy*  
PRINCIPAL  
The National College  
Jayanagar, Bangalore-70.



## Registered Office:

'KNND HOUSE' No. 153-166/1 East End Main Road, J.P Nagar,  
Bengaluru - 560078 // Tel: 080-26588870 [www.knndassociates.com](http://www.knndassociates.com)  
GSTIN : 29AABCK3022G1ZV | CIN : U05150KA1999PTC025205 | IEC NO. : 0705001202

# LAKSHMI MANJUNATH ENTERPRISES

NO 1351, Muthayamma Temple Road, Hebbagodi Bangalore 560099

GST NO: 29ANWPL5315Q1ZY

## INTERNSHIP CERTIFICATE

This is to certify that **Mr. FRANKLIN PRAKASH** bearing *Register No.18NCJC676*, B.Com final year student, **The National College, Autonomous**, Jayanagar, Bangalore has successfully completed an internship of six weeks (*from 02/11/2020 to 14/12/2020*) under the guidance of **Mr. Harsih – Manager** at this organization, towards the fulfillment of award of “Bachelor of Commerce” during the year 2020 – 2021.

During the period of his internship he has exhibited punctuality and diligence. We wish him every success in life.



Signature and Seal of the company authorized person or head

Date: 15/12/2020

Place: Bengaluru

  
PRINCIPAL  
The National College  
Jayanagar, Bangalore-70.





Dated: 24<sup>th</sup> December 2020

To whomsoever it may concern

This is to certify that **Mr. Gajendra.V** bearing register no. **18NCJC677** B.Com final year student, **The National College**, Autonomous, Jayanagar, Bangalore has successfully completed an internship of six weeks (from **30.10.2020 to 10.12.2020**) under the guidance of **Mr. Shuvendu Das, Assistant Finance Manager, Finance department** at our organization, towards the fulfillment of award of "Bachelor of Commerce" during the year 2020-2021.

The topic of his internship was '**Study and analysis of Financial Statements and Introduction to Managerial Accounting**'

During the period of his internship he has exhibited punctuality and diligence. We wish him every success in life.

*Shuvendu Das*  
24/12/20  
**Name: Shuvendu Das**  
**Designation: Asst Manager Finance**

Date: 24<sup>th</sup> December 2020  
Place: Bengaluru. Karnataka

**Virisa Icosys Technology Private Limited**  
130, Bull temple Road  
Basavanagudi  
Bengaluru-560018



*To. Gajendra*  
**PRINCIPAL**  
**The National College**  
Jayanagar, Bangalore-70.



## TO WHOM IT MAY CONCERN

This is to confirm you that Ms. GOPINATH YADAV has selected as a HR-Intern at VSS Innovative Technologies, Bangalore from 8th March 2021. During the tenure, you are going to learn and do the work and follow the office guidelines. In this Internship period you are not going to get any stipend. VSS Innovative Technologies wishes all success in your career.

VSS Innovative Technologies



Authorized Signatory



PRINCIPAL  
The National College  
Jayanagar, Bangalore-70.



25<sup>th</sup> November 2020

## CERTIFICATE OF INTERNSHIP

This is to Certify that Ms. Harshitha K bearing Reg No : 18NCJC678, B.com final year student, The National College, Autonomous, Jayanagar, Bangalore has successfully completed her internship of six weeks from 5<sup>th</sup> Oct to 19<sup>th</sup> Nov 2020 under the guidance of Manivannan - Accounts Manager (Accounts & Finance Department) in our organization, towards the fulfillment of award of "Bachelor of Commerce" during the year 2020 – 2021.

During the period of her internship, she has exhibited punctuality and diligence.

We wish her every success in life

Thanks & Regards,



M. Dhanasekaran  
Director – Admin & Technical



PRINCIPAL  
The National College  
Jayanagar, Bangalore-70.





# Karnataka Plastoo Industries (P) Ltd.



DMN. OFF. & FACTORY :

110/E & F, Bommasandra Industrial Area, Hebbagodi Village, BANGALORE - 560 099

Phone : 2783 2459 / 2783 2460 / 4165 8088 / 41658089 Fax : 2783 6461

mail : accounts@kplastooind.com / ceo@kplastooind.com

IN NO : U25200KA1971PTC002098

This is certify that Miss. **HEMASHREE T S** bearing Register No **18NCJC679**, B.COM final year student, **THE NATIONAL COLLEGE, AUTONOMOUS**, JAYANAGAR, Bangalore has successfully completed a internship of six weeks (from 01-10-2020 to 14-11-2020) under the guidance of **Mr. SUDHRASAN S., Accounts Officer** of the organization, towards the fulfilment of award of "Bachelor of commerce" during the year 2020-2021.

During the period of her internship she exhibited punctuality and diligence. We wish her every success in life.

Signature

Date: 16-11-2020

Place: Bangalore

For Karnataka Plastoo Industries (P) Ltd.

Authorised Signatory

930130618



*S. Sudh*  
PRINCIPAL  
The National College  
Jayanagar, Bangalore-70.



**prakash**

**Roadlines Private Limited**

Regd. Office : # 108, 3rd Cross, Kalasipalyam New Ext., Bengaluru - 560 002. Phone : 22220293  
Corporate Office : # 3, Dr. M.H. Marigowda Road, Near Lalbagh, Bengaluru - 560 027  
Phone : 22238676, 22232625, 22215123, 22220705 Fax : 080-22236005  
PAN NO - AABCP2953K / CIN - U85110KA1961PTC001423 / GST NO - 29AABCP2953K1Z3  
Email : corporate@prakashroadlines.com

This is to certify that **Ms. JAHNAVI S G** bearing Register Number **18NCJC641**, B.com Final Year student, **The National College, Autonomous, Jayanagar, Bangalore** has successfully completed internship of seven weeks (from **31/12/2020** to **31/01/2021**) under the guidance of **Mrs. NIRMALA C**, Personnel Officer towards the fulfillment of award of "Bachelor of Commerce" during the year 2020-2021.

FOR PRAKASH ROADLINES PRIVATE LIMITED

*Nirmala C*

**NIRMALA C**  
PERSONNEL OFFICER



Date: 31/01/2021  
Place: Bangalore

*D. Sush*

**PRINCIPAL**  
**The National College**  
**Jayanagar, Bangalore-70.**



# DHANUKA ENTERPRISES PRIVATE LIMITED

CIN U14101KA1997PTC083498

GSTN 29AABCK4261B1ZU



This the certify that **Ms Jhansi K** bearing register No. **18NCJC732**, B Com Final Year student, **THE NATIONAL COLLEGE, AUTONOMOUS**, Jayanagar, Bangalore has successfully completed a internship of six weeks (from 13-10-2020 to 03-12-2020) under the guidance of **Mr. Amit Dhanuka**, Director of **Dhanuka Enterprises Pvt Ltd.** at this organization, towards the fulfilment of award of 'Bachelor of Commerce' during the year 2020-2021.

During the period of her internship she exhibited punctuality and diligence. we wish her every success in life.

  
Signature

Date: 03-12-2020

Place: Bangalore



  
PRINCIPAL  
The National College  
Jayanagar, Bangalore-70.

POCO  
SHOT ON POCO F





Date: 03-Dec-2020

## INTERNSHIP COMPLETION CERTIFICATE

This is to certify that **Jithendra R (18NCJC 680)** student Of **National College Jayanagar** has successfully completed her/his Internship In **Accounting and Finance at Mlewzklawz IT Solutions Pvt Ltd.** in our organization period from 19-Oct-2020 to 02-Dec-2020.

Her/His Performance and conduct during this period was good. We wish all the best in future endeavour.

For Mlewzklawz IT Solutions Pvt. Ltd.

Thanks and regards,

Kavita Solanki

7411000877



PRINCIPAL  
The National College  
Jayanagar, Bangalore-70.



**IDEAL CARPETS LIMITED**  
**EXPORT DYEING & SPINNING**

RECOGNIZED EXPORT HOUSE BY GOVERNMENT OF INDIA



**Dated- 20-11-2020**

REGD OFFICE  
RAJNAGAR, G.T. ROAD,  
GOPIGANJ, 221303  
DIST- BHADRAI (U.P.) INDIA  
PHONE: (9414) 23275, 23245  
FAX: (9414) 23175, 23245  
Email: [info@idealcarpets.net](mailto:info@idealcarpets.net)

**TO WHOM SO EVER IT MAY CONCERN**

This is to certify that Ms Jyoti Yadav, Reg No: (18NCJC719) has joined our organization as an intern on 01 st October till 19th November. Her study period was for 50 days.

She has completed her organization studies in 4 divisions of our organization which includes production, spinning, dyeing and managerial department.

During the study period her performance was found to be excellent. We wish all the success in the future endeavours.

For : Ideal Carpet Limited

  
Kudan Arya  
Marketing Head

  
PRINCIPAL  
The National College  
Jayanagar, Bangalore-70.



# FUTURE RETAIL



DATE: 21-JUNE-2021

## CERTIFICATE

This is to certify that Ms. **KARTHIKA.K** the student of 5<sup>th</sup> semester B.COM bearing REG NO : 17NCJC418 studying in THE NATIONAL COLLEGE has done project report on "Organizational Study with Reference to Big Bazaar, Bangalore" in our organization for a period of **One month**

During her tenure with us, we found her to be sincere, diligent and hardworking and her participation in the above program was observed to be satisfactory.

FOR FUTURE RETAIL LIMITED,

**SANJANA S RAO**  
Senior Executive-Human Resource.

**BIG BAZAAR-Gate Way**  
(A Division of Future Value Retail Ltd.)  
Gateway Jayanagar, 45/1  
Marehalli, J.P. Nagar, 2nd Phase  
BANGALORE-560 069

**PRINCIPAL**  
The National College  
Jayanagar, Bangalore-70







# G.M. GROUP OF INDUSTRIES

A UNIT OF PRINTING AND PACKAGING  
Mfrs. Of corrugated boxes, printing cartons, E-Flute cartons

+919844341931

+917353989828

DATE : 5<sup>th</sup> December 2020

## CERTIFICATE

This is to certify that **MS. Aishwarya Melmari (REG NO: 18NCJC602) BCOM** student of **THE NATIONAL COLLEGE JAYANAGARA, BANGLORE** has undergone internship for a period from **27<sup>th</sup> October to 5<sup>th</sup> December 2020** in our GM Group of Industries , Bangalore under guidance of Soumya A J-HR Executive.

During the above period the performance and conduct of **MS Aishwarya Melmari** has been satisfactory.

For Gm Group Of Industries



Narayanaswamy B.G

PROPRIETER

  
PRINCIPAL  
The National College  
Jayanagar, Bangalore-70.





Date: 20-Nov-2020

## INTERNSHIP COMPLETION CERTIFICATE

This is to certify that **Kavya .B(18NCJC682)** student Of **National College Jayanagar** has successfully completed her/his Internship In **Accounting and Finance at Mlewzklawz IT Solutions Pvt Ltd.** in our organization period from 05-Oct-2020 to 20-Nov-2020.

Her/His Performance and conduct during this period was good. We wish all the best in future endeavour.

For Mlewzklawz IT Solutions Pvt. Ltd.

Thanks and regards,

Kavita Solanki

7411000877



PRINCIPAL

The National College  
Jayanagar, Bangalore-70.





**Smitam®**

(A National NGO Registered Under Societies Registration Act of 1960)  
(Registration Year 2018-19, Registration No. JPN-4-00056-2018-19)  
No. 234 Doddakalasangraha, Kanakapura Main Road, Bangalore 560062  
Phone No: +91 6366680903 Email: smitam.ngo@gmail.com

Date: 23/12/2020

This is to certify that **Mrs Keerthana .S** bearing Register NO. **18NCJC708**, B.com final year student , **The National College , Autonomous , Jayanagar , Bengaluru** has successfully completed an internship from 9/11/2020 – 23/11/2020 , under the guidance of **Mrs MANDAARA HEBBAR BV** , Volunteer's management lead at the organization , towards the fulfillment of award of "Bachelor of commerce" during the year 2020-2021 .

During the period of her internship she exhibited punctuality and diligence . We wish her every success in life .

Smitam  
234, Doddakalasangraha  
Kanakapura Main Road  
Bangalore - 560062

Signature with seal

Date: 23/12/2020

Place: Bengaluru

PRINCIPAL  
The National College  
Jayanagar, Bangalore-70.







**DARSHAN  
PIXEL PRINTS**

## CERTIFICATE

This is to certify that **Mr. KIRAN.V.A** bearing Register No. **18NCJC615, B.COM** final year student of "The National College, Autonomous", Jayanagar, Bangalore has successfully completed an internship of six weeks from 23-11-2020 to 06-01-2021 under the guidance of **MURALIDHAR**, CEO of the organisation, towards the fulfillment of award of "Bachelor of Commerce" during the year 2020-2021.

During the period of his internship, he has exhibited punctuality and diligence.

We wish him every success in his future endeavors.

For **DARSHAN PIXEL PRINTS LLP**

For **DARSHAN PIXEL PRINTS LLP**

Authorized Signatory

**AUTHORIZED SIGNATORY**

Date : 18-01-2021

Place : Bangalore

*[Handwritten Signature]*  
**PRINCIPAL**  
**The National College**  
**Jayanagar, Bangalore-70.**



**DARSHAN PIXEL PRINTS LLP**

27/4A2, JIGANI LINK ROAD, BOMMASANDRA INDUSTRIAL AREA, BANGALORE - 562 105  
(T) : 27839064, 27839065 e-mail : darshanpixelprints@gmail.com

## CERTIFICATE

Date: 14/12/2020

This is to certify that **Mr. Kishore Kumar D** ( Reg No – 18NCJC683), B. Com student from The National College has completed his internship named "**ORGANISATION STUDY**" in our establishment from 02/11/2020 to 05/12/2020

During his Internship, **Mr. Kishore Kumar D** spent quality time with all department. He got a broad insight into the company and got introduced top various departments.

We wish his all success in future endeavours

**For HDFC BANK LTD**

**(Ankit Kumar Kashyap)**

**Preferred Manager**



*[Handwritten Signature]*  
**PRINCIPAL**  
**The National College**  
**Jayanagar, Bangalore-70**



This is to certify that **Mr.KISHORE.N** bearing Register No.18NCJC616.com Final Year Student ,  
**THE NATIONAL COLLEGA ,Autonomous ,JayanagarBanglore** has Successfully Completed a  
internship of Seven weeks (from10-11-2020 to 24-12-2020) under the guidance of **Mr.Nithin**  
,Manager –HR at the organization,toward the fulfillment of award of" bachelor of commerce"  
during the year 2020-2021

During the period of his intership he exhibited punctuality and diligen.we wish him every  
success in life.

Date: 24-12-2020

Place:Banglore

*Nithin*  
*24/12/2020*

Signature

Reliance Retail Ltd.  
Sarala Grand Hyper Mart  
CMC Khata No. 1402,  
Bilekahalli Village, Begur Hobli,  
Bannerghatta Main Road,  
BANGALORE - 560 076.

*D. Sush*  
PRINCIPAL  
The National College  
Jayanagar, Bangalore-70.







To,

Kumar Prasad  
3<sup>rd</sup> year student  
National College  
**Bangalore**  
Email: [Kumarprasad123@gmail.com](mailto:Kumarprasad123@gmail.com)

**DATE: 15 March 2021**

**Place: Bangalore**

Dear Mr. Kumar Prasad,

Subject: Offer Letter for Internship

As sited in the above subject, we are pleased to offer you the position of "Intern — Marketing" at ARKA Eduserve Pvt Ltd. Bangalore.

Please find the following confirmations of the specifics of your Internship.

- **Position Title:** Intern-Marketing
- **Start Date:** March 15, 2021
- **End Date:** April 13, 2021
- **Number of working hours :** 30 hours per week
- **Reporting Relationship/Supervisor:** You will be reporting to Mr. Rajiv BV, Head- Operations and Marketing of ARKA Eduserve Pvt LTD, Bangalore.  
Mr. Rajiv may be contacted by phone +919900080647 or  
by email; [Rajiv@jgishools.in](mailto:Rajiv@jgishools.in)



*[Handwritten Signature]*  
PRINCIPAL  
The National College  
Jayanagar, Bangalore-70.



**CERTIFICATE**

This is to certify that **Mr. Lakshmikanth N** bearing Register No. 18NCJC618, B Com Final year student of "The National College, Autonomous", Jayanagar, Bangalore has been Successfully completed an internship of six weeks from 26/10/2020 to 05/12/2020 under the guidance of Mr. Anand T(Manager) at the organization, towards the fulfillment of award of "Bachelor of Commerce" during the year 2020-2021.

During the period of his internship, he has exhibited punctuality and diligence.

We wish him every success in his future endeavors.

For Girias Investment Pvt Ltd  
**GIRIAS INVESTMENT PVT. LTD.**  
No. 178, Kathriguppe Main Road,  
BSK 3rd Stage, Bangalore - 560005

Anand T  
(Manager)

Date: 10/12/2020  
Place: Bangalore

**PRINCIPAL**  
**The National College**  
Jayanagar, Bangalore-70.



Registered Office

# 47, 3rd Floor, 15th Cross, 3rd Main, Margosa Road,  
Malleshwaram, Bangalore - 560 003.

25<sup>th</sup> November 2020

### CERTIFICATE OF INTERNSHIP

This is to Certify that Ms. Lakshmi Priya, bearing Reg No : 18NCJC684, B.com final year student, The National College, Autonomous, Jayanagar, Bangalore has successfully completed her internship of six weeks from 5<sup>th</sup> Oct to 19<sup>th</sup> Nov 2020 under the guidance of Manivannan - Accounts Manager (Accounts & Finance Department) in our organization, towards the fulfillment of award of "Bachelor of Commerce" during the year 2020 – 2021.

During the period of her internship, she has exhibited punctuality and diligence.

We wish her every success in life

Thanks & Regards



M Dhanasekaran  
Director – Admin & Technical



PRINCIPAL  
The National College  
Jayanagar, Bangalore-70.







# Powernet Solutions Pvt Ltd.

No. 788, Jalaram Industrial Estate, Arekere Gate,

Bannergatta Road, Bangalore - 560 076.

Tele : 080-2648 7741 / 2648 7761

CIN : U31909KA1999PTC025040

GST No. : 29AABCP7283Q1Z1

## CERTIFICATE

This is to certify that Ms. LAVANYA.N bearing Register No. 18NCJC619, B.Com final year student, The National College, Autonomous, Jayanagar, Bangalore has successfully completed a internship of six weeks from 12-10-2020 to 21-11-2020 under the guidance of SANDEEP GOWDA Accountant, Accounts Department at this organization, towards the fulfillment of award of "Bachelor of Commerce" during the year 2020 – 2021.

During the period of her internship she has exhibited punctuality and diligence.

We wish her every success in life.

of POWERNET SOLUTIONS PVT. LTD

T. S. Bhageesathi  
DIRECTOR  
Signature

Date: 23-11-2020.  
Place: Bangalore.



T. S. Subh  
PRINCIPAL  
The National College  
Jayanagar, Bangalore-70.





**DARSHAN**  
PIXEL PRINTS

## CERTIFICATE

This is to certify that **Mr.LIKITH B.M** bearing Register No. **18NCJC621, B.COM** final year student of "The National College, Autonomous", Jayanagar, Bangalore has successfully completed an internship of six weeks from 23-11-2020 to 06-01-2021 under the guidance of **MURALIDHAR**, CEO of the organisation, towards the fulfillment of award of "Bachelor of Commerce" during the year 2020-2021.

During the period of his internship, he has exhibited punctuality and diligence.

We wish him every success in his future endeavors.

For **DARSHAN PIXEL PRINTS LLP**

**AUTHORIZED SIGNATORY**

Date : 18-01-2021

Place : Bangalore

**PRINCIPAL**  
**The National College**  
**Jayanagar, Bangalore-70.**



**DARSHAN PIXEL PRINTS LLP**

27/4A2, JIGANI LINK ROAD, BOMMASANDRA INDUSTRIAL AREA, BANGALORE - 562 105

(T) : 27839064, 27839065 e-mail : darshanpixelprints@gmail.com



Ref: GRID / INTERNSHIP/2020

19<sup>th</sup> December, 2020

**TO WHOMSOEVER IT MAY CONCERN**

CERTIFICATE

This is to certify that Likith Gowda, Reg No. 18NCJC685, Bcom final year student of The National College, Jayanagar, Autonomous, Jayanagar, Bangalore has successfully completed an Internship of six weeks from 4th Nov 2020 to 19th Dec 2020 under the guidance of Mrs. Vani S.P, HR Administration at "GRID R&D" BANGALORE towards the fulfilment of " Bachelor of Commerce" during the year 2020 - 2021

We found him punctual, agile and efficient.

We wish him prosperity in the posterity.

for GRID R & D

Vani S.P  
HR Administration

PRINCIPAL  
The National College  
Jayanagar, Bangalore-70.

**GRID R&D**  
1980, 3rd Floor, 26th Cross,  
7th Main, BSK 2nd Stage,  
Bangalore-70





Ref :

Date :

This is to certify that **Mr. H K LOHITH GOWDA** bearing *Register No. 17NCJC483* , B.Com final year student, **The National College, Autonomous, Jayanagar, Bangalore** has successfully completed a internship of six weeks (*from 09/11/2020 to 19/12/2020* ) under the guidance of **Mr. PRASAD, FINANCE MANAGER**, at this organization, towards the fulfillment of award of "Bachelor of Commerce" during the year 2020 – 2021.

During the period of his internship he has exhibited punctuality and diligence.  
We wish him/her every success in life.



Date:  
Place:

**KALPATARU AGRO SUPPLIES**  
No,112/7, Ground Floor,  
Panthara Palya, R.R. Nagar,  
Bengaluru - 560 039.

Signature and Seal of the company authorized person or head



  
PRINCIPAL  
The National College  
Jayanagar, Bangalore-70.

Date: 19.12.2020

Place: Bangalore

**TO WHOM SO EVER IT MAY CONCERN**

This is to certify that Mr./Ms. R L Madhusudhan Reddy bearing Register No.18NCJC722, B.Com final year student, The National College, Autonomous, Jayanagar, Bangalore has successfully completed a internship under the Guidance of "Integra Office Solutions "at this organization, towards the fulfillment of award Of "Bachelor of Commerce" during the year 2020 – 2021.

During the period of his internship he has exhibited punctuality and diligence.

We wish him/her every success in life.

For Integra Office Solutions



  
PRINCIPAL  
The National College  
Jayanagar, Bangalore-70.





# SLV ENTERPRISES PVT. LTD.

**SLV AQUA KING™**  
(Packing Drinking Water)



# 9, Prathibha Industrial Estate, Yelachenahalli, Kanakapura Main Road, Bangalore - 560 078.  
E-mail : slvaquaking@gmail.com / slvbiotuel@gmail.com • Website : www.slvgroups.in  
Phone : 080 26666612, Mob. : 9986013879

This is to certify that **Ms.MANASA L** bearing *Register No. 18NCJC622*,  
B. Com final year student, **The National College, Autonomous, Jayanagar,**  
Bangalore has successfully completed a internship of six weeks (*from*  
*11/11/2020 to 25/12/2020*) under the guidance of **T. T NAGESH,**  
**COMPANY DIRECTOR** at this organization, towards the fulfillment of  
award of "Bachelor of Commerce" during the year 2020 – 2021.

During the period of her internship she has exhibited punctuality and  
diligence. We wish her every success in life.

FOR SLV ENTERPRISES PVT LTD

Date : 12/03/2021

Place : Bangalore

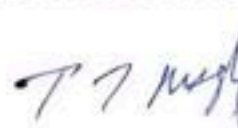
  
T.T NAGESH  
(DIRECTOR)



  
PRINCIPAL  
The National College  
Jayanagar, Bangalore-70.



**SLV Aqua King™**  
Package Drinking Water

**SLV Biom Surya**  
Stove & Pellets

**SLV Land Developers**  
& Builders

**SLV Water Tanker**  
Supply

**SLV Commercial**  
Gas Distributer



This is to certify that Mr. **MANOJ.S** bearing Register No. **18NCJC687**, B.Com final year student, **The National college, Autonomous**, Jayanagar, Bangalore has successfully completed a internship of seven weeks (from 19-10-2020 to 03-12-2020) under the guidance of **Mr. M N SHIVARAMAKRISHNAN**, Accounts and Admin manager at the organization, towards the fulfillment of award of "Bachelor of commerce" during the year 2020-2021.

During the period of his internship he exhibited punctuality and diligence. We wish him every success in life.

Signature

Date: 03-12-2020

Place: Bangalore



*[Handwritten Signature]*  
PRINCIPAL  
The National College  
Jayanagar, Bangalore-70.



18.11.2020

## CERTIFICATE

This is to certify that **Mr. Manu N M.** (Reg No-18NCJC624), B. Com student from The National College has completed his internship named "**Organisational Study**" in our establishment from 20.10.2020 to 12.11.2020.

During his Internship, **Mr. Manu N M** spent quality time with All department. He got a broad insight into the company and got introduced to various departments.

We wish him all success in future endeavors.

FOR SANSERA ENGINEERING LTD.,



(MANOJ KUMAR B M)  
ASST. MANAGER – HR



PRINCIPAL  
The National College  
Jayanagar, Bangalore-70.



**SANSERA ENGINEERING LIMITED**

(Formerly Sansera Engineering Pvt Ltd)

This is to certify that **Mr. Nanjunde Gowda M** bearing Register No **18NCJC725**, B.Com final year student. **The National College Autonomous Jayanagar**, Bangalore has successfully completed a internship of six weeks (from **25/07/2020** to **07/09/2020**) under the guidance of **Mr. Aravinda B**, **Managing director** at this organization towards the fulfillment of award of "Bachelor of Commerce during the year 2020 - 2021.

During the period of his internship, he has exhibited punctuality and diligence. We wish him every success in life.

**For Xtreme Media solutions Pvt. Ltd.**



Authorized Signatory

**Aravinda B**

**Managing director**

**PRINCIPAL**  
**The National College**  
**Jayanagar, Bangalore-70.**

Date: 07/09/2020

Place: Bengaluru



---

**Xstream Media Solutions Pvt. Ltd.**

2<sup>nd</sup> Floor, 8<sup>th</sup> F Main Rd, Jayanagar East, Jaya Nagara 1<sup>st</sup> Block, Jayanagar,  
Bengaluru, Karnataka 560011 aravidna@xstream biz 8971519734



### CERTIFICATE

This is to certify that Mr. Naveen Kumar R bearing Register No. 18NCJC626, B.Com final year student of "The National College, Autonomous", Jayanagar, Bangalore has successfully completed an internship of six weeks from 01-10-2020 to 15-11-2020 under the guidance of Antony Thomas, Director of Finance, at the organization, towards the fulfillment of award of "Bachelor of Commerce" during the year 2020-2021.

During the period of his internship, he has exhibited punctuality and diligence.

We wish him every success in his future endeavors.

For Android Motors Private Limited



**Antony Thomas**  
Director(Finance)

Date : 13.01.2021

Place: Bangalore



**PRINCIPAL**  
The National College  
Jayanagar, Bangalore-70.



**Registered Office :**

"Kantha Court", 2nd Floor, No. 132/9/10,  
Lalbagh Road, Bangalore - 560 027  
tel : +91 - 80 - 4114 6403, 4114 6404  
2222 2263, 2222 0056  
fax : +91 - 80 - 2229 0213  
email : info@androidmotors.com

**Service Centre :**

# 53/2, 53/3,  
9th K. M. Hosur Road,  
M.B.T. Compound,  
Bommanahalli, Bangalore - 58.  
tel : +91 - 80 - 4110 8287

Survey No. 27/2,  
Next to Kailash Body Builders,  
Balagaranahalli, Hosur Road,  
Attibele, Bangalore - 107.  
tel : +91 - 80 - 2782 0279

Bangalore Bypass,  
NH-75, Madanahalli Post  
Kondarajannahalli Gate,  
Kolar - 563101.  
tel : +91 - 80 - 52295999

Shop No-1, Kurubaspet Road  
Near Reliance Petrol Bunk,  
Hoskote, Bangalore  
Rural Dist - 562 114  
tel : +91 7406544545  
+91 9972656795

18.11.2020

CERTIFICATE

This is to certify that **Mr. Nithin J.** (Reg No-18NCJC627), B. Com student from The National College has completed his internship named "**Organisational Study**" in our establishment from 20.10.2020 to 12.11.2020.

During his Internship, **Mr. Nithin J** spent quality time with All department. He got a broad insight into the company and got introduced to various departments.

We wish him all success in future endeavors.

FOR SANSERA ENGINEERING LTD.,



(MANOJ KUMAR B M)  
ASST. MANAGER – HR



PRINCIPAL  
The National College  
Jayanagar, Bangalore-70.





# SLV ENTERPRISES PVT. LTD.

SLV AQUA KING™  
(Packing Drinking Water)



# 9, Prathibha Industrial Estate, Yelachenahalli, Kanakapura Main Road, Bangalore - 560 078.  
E-mail : slvaquaking@gmail.com / slvbiofuel@gmail.com • Website : www.slvgroups.in  
Phone : 080 26666612, Mob. : 9986013879

This is to certify that **Ms. .NIVIDITHA K** bearing *Register No. 18NCJC628*, B. Com final year student, **The National College, Autonomous, Jayanagar, Bangalore** has successfully completed a internship of six weeks (*from 11/11/2020 to 25/12/2020*) under the guidance of **T . T NAGESH , COMPANY DIRECTOR** at this organization, towards the fulfillment of award of "Bachelor of Commerce" during the year 2020 – 2021.

During the period of her internship she has exhibited punctuality and diligence. We wish her every success in life.

FOR SLV ENTERPRISES PVT LTD

Date: 12/03/2021

Place: Bangalore

T.T NAGESH

( DIRECTOR )



*T. T. Nagesh*  
PRINCIPAL  
The National College  
Jayanagar, Bangalore-70.

SLV Aqua King™  
Package Drinking Water

SLV Biom Surya  
Stove & Pellets

SLV Land Developers  
& Builders

SLV Water Tanker  
Supply

SLV Commercial  
Gas Distributer



# BRAHMA BREW WORKS

# 35/38, 24<sup>th</sup> Main Road, Puttenhalli, JP Nagar 7<sup>th</sup> Phase,

Bengaluru - 560078. Enquiry : 7483197213

GSTIN : 29AMKPR9019A2ZT | PAN: AMKPR9019A



Date: November 15, 2020

## Sub : Certificate of completion

This is to certify that Ms . Pallavi SR Regd. No. 18NCJC690 student of B. Com. 5<sup>th</sup> Semester at National College Jayanagar, Bengaluru has successfully completed her project work on the topic "Organizational Study" during the period of October 1, 2020 to November 15, 2020 in our organization under the guidance of Mr. Raghab Joshi (Operations Manager).

She has shown extensive interest in the project work that was worth appreciating. We wish her a bright future.



  
PRINCIPAL  
The National College  
Jayanagar, Bangalore-70.





This is to certify that **Mr. Pavan Kumar .N** bearing Register No. 18NCJC631

B.Com final year student , **The National College, Autonomous , Jayanagar**

Bangalore has successfully completed a internship of six weeks from

19.10.2020 to 01.12.2020 under the guidance of **Shivu Accounts Manager** at

The organization , towards the fulfilment of award of "Bachelor of Commerce"

During The year 2020-2021 .

During the period of his internship he has exhibited punctuality and diligence.

We wish him every success in life.

Arvee Hydraulics  
For ARVEE HYDRAULICS

Authorized Signatory

Date : 12.12.2020

Place : Bangalore



*[Handwritten Signature]*

PRINCIPAL

The National College  
Jayanagar, Bangalore-70.

## CERTIFICATE

Date: 14/12/2020

This is to certify that **Miss. Pavithra C** ( Reg No – 18NCJC632), B.COM STUDENT from the National College has completed her Internship name "**ORGANISATION STUDY**" in our establishment from 02/11/2020 to 05/12/2020.

During her Internship, **Miss. Pavithra C** spent quality time with all department. He got a broad insight into the company and got introduce to various departments.

We wish her all success in future endeavours.

For HDFC BANK LTD



Ankit Kashyap  
Preferred Manager

  
PRINCIPAL  
The National College  
Jayanagar, Bangalore-70.







This is to certify that **Mr./Ms. POOJA KASHYAP S** bearing *Register No. 18NCJC710*, B.Com final year student, **The National College, Autonomous, Jayanagar, Bangalore** has successfully completed a internship of six weeks (*from 27<sup>TH</sup> OCT to 10<sup>TH</sup> DEC 2020*) under the guidance of **MS. POOJASHREE R (COO)** at this organization, towards the fulfillment of award of "Bachelor of Commerce" during the year 2020 – 2021.

During the period of his internship, she has exhibited punctuality and diligence. We wish him/her every success in life.

Signature of the company authorized person  
(Chief operating officer)

Date: 10/12/2020  
Place: Bangalore.



PRINCIPAL  
The National College  
Jayanagar, Bangalore-70.

## CERTIFICATE

Date: 14/12/2020

This is to certify that **Miss. Pavithra C** ( Reg No – 18NCJC632), B.COM STUDENT from the National College has completed her Internship name "**ORGANISATION STUDY**" in our establishment from 02/11/2020 to 05/12/2020.

During her Internship, **Miss. Pavithra C** spent quality time with all department. He got a broad insight into the company and got introduce to various departments.

We wish her all success in future endeavours.

For HDFC BANK LTD



Ankit Kashyap  
Preferred Manager



PRINCIPAL  
The National College  
Jayanagar, Bangalore-70.





# Findx Pro

Redefine yourself

#569, 1st Floor, 30th main, Banagiri nagar, BSK 3rd stage, Bengaluru-85

Ref:

Date: 05/03/2021

To,  
Mr. Arun Kumar  
HOD-Dept.of Commerce,  
National Degree College,  
7th Block, Jayanagar,  
Bengaluru-560070

Sub: Rotational Internship Letter- Mr. Prajwal U (Reg No.16NCJC536)

This is to certify that Mr. Prajwal U Reg No.16NCJC536 has joined our Organisation on 8 March 2021 and he will be working as internship trainee in **Production, Sales and Accounts** Department in our **FINDX PRO** for the period of 28-30days.

FINDX PRO

*Arun Kumar*

*Sudha*  
PRINCIPAL  
The National College  
Jayanagar, Bangalore-70.





# Sneha Clothing

# 5, Shamanna Garden, Jayanahalli,  
Chunchagatta Main Road, J.P. Nagar - post,  
Bangalore - 560 078 Phone: 080 2653 0157  
Email: snehacreation.bottoms@gmail.com  
GST: 29ACEFS8387C120

This is to certify that Mr. PRAMODKUMAR.S bearing Register No.18NCJC634 B.Com final year student, The National College, Autonomous, Jayanagar, Bangalore has successfully completed a internship of six weeks (from 24<sup>th</sup> Oct.2020 to 7<sup>th</sup> Dec.2020) under the guidance of Nataraja M – Accounts Manager at this organization, towards the fulfilment of award of "Bachelor of Commerce" during the year 2020 – 2021.

During the period of his internship he has exhibited punctuality and diligence. We wish him every success in life.

  
(Nataraja M – Accounts Manager)

Date: 22/12/2020  
Place: Bangalore

  
PRINCIPAL  
The National College  
Jayanagar, Bangalore-70.



This is certify that Miss. **PRATHIBHA R** bearing Register No. **18NCJC692**, B.Com final year student, **THE NATIONAL COLLEGE, AUTONOMOUS**, Jayanagar, Bangalore has successfully completed a internship of six weeks (from 14-10-2020 to 28-11-2020) under the guidance of **Mr. FIROZE**, Business Head at the organization, towards the fulfillment of award of "Bachelor of commerce" during the year 2020-2021.

During the period of her internship she exhibited punctuality and diligence. We wish her every success in life.

  
Signature

Date: 28-11-2020

Place: Bangalore

  
PRINCIPAL  
The National College  
Jayanagar, Bangalore-70.





**MARKETONIX**  
YOUR VISION IS OUR MISSION

Ref No: MSPL16052021

Date: 16/05/2021

TO WHOM IT MAY CONCERN

To,  
**MS. PREETHI J**  
(Interns)

**Sub: Experience Letter**

It is to certify that **MS.Preethi.J** was working as Interns with us as interns from period **08<sup>th</sup> March, 2021** to **07<sup>th</sup> April 2021** as per the **Marketonix's** employment record.

During her employment, **MS.Preethi.J** has perused knowledge & experience in our organization.

During her period, we found her to be Professional, knowledgeable and result oriented with theoretical & practical understanding of work requirements.

Overall she performed her duties and responsibilities cheerfully with attention to detail at all times. With her enthusiasm to work, learn and progress, I am certain that she would make a great employee to any enterprise.

For, Marketonix Services Private Limited.

Yours Sincerely,

HR TEAM  
**MARKETONIX SERVICES PRIVATE LIMITED**



*[Handwritten Signature]*

**PRINCIPAL**  
**The National College**  
Jayanagar, Bangalore-70.







**Bengaluru Urban, Bengaluru Rural & Ramanagara  
District Co-operative Milk Producers' Societies Union Ltd., Bengaluru-29**

No.Bamul/Admn-10/cert/N-38/2020-21

Date:05.02.2021

**CERTIFICATE**

This is to certify that **Ms.Priya.H.R**, Reg.No.18NCJC636,  
Student of The National College Studies B.com part of  
Curriculum has undertaken project entitled as "**Organisation  
Study**" at Bengaluru Urban, Bengaluru Rural and Ramanagara  
District Co-operative milk producer's Societies Union Ltd., during  
10.11.2020 to 10.12.2020.

  
General Manager(Admn)

Bengaluru Co-op Milk Union Ltd.,



PRINCIPAL

The National College  
Jayanagar, Bangalore-70.





**Bengaluru Urban, Bengaluru Rural & Ramanagara  
District Co-operative Milk Producers' Societies Union Ltd., Bengaluru-29**

No.Bamul/Admn-10/cert/N-38/2020-21

Date:05.02.2021

**CERTIFICATE**

This is to certify that **Ms.Priya.H.R**, Reg.No.18NCJC636,  
Student of The National College Studies B.com part of  
Curriculum has undertaken project entitled as "**Organisation  
Study**" at Bengaluru Urban, Bengaluru Rural and Ramanagara  
District Co-operative milk producer's Societies Union Ltd., during  
10.11.2020 to 10.12.2020.

**General Manager(Admn)**  
**Bengaluru Co-op Milk Union Ltd.,**

**PRINCIPAL**  
**The National College**  
**Jayanagar, Bangalore-70.**



# FUTURE RETAIL

DATE: 16-DECEMBER-2020

## CERTIFICATE

This is to certify that Ms. PRIYANKA D the student of 5<sup>th</sup> semester B.COM bearing USN NO : 18NCJC638 studying in The National College has done project report on "Organizational Study with reference to Big Bazaar " for a period of six weeks During her tenure with us, we found her to be sincere, diligent and hardworking and her participation in the above program was observed to be satisfactory.

FOR FUTURE RETAIL LIMITED,

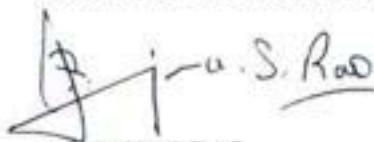

**SANJANA S RAO**  
Human Resource.  
People Office



**PRINCIPAL**  
The National College  
Jayanagar, Bangalore-70.

**BIG BAZAAR**  
Kothanur Village, J.P. Nagar, Puttenahalli  
Pattenahalli, RBI Layout, J.P. Nagar  
BANGALORE-560078



### Future Retail Limited

1. Store Address : RBI Layout, Puttenahalli, J.P. Nagar, Kothanur Village, Utharahalli Hobli, Bangalore-560078.
2. Zonal Office : 1st Floor Pasadena, 18/1, 10th Main, Ashoka Pillar Road, Jayanagar 1st Block, Bangalore - 560 011. India T : +91 80 433040000 F : +91 80 26577530
3. Regd Off: Knowledge House, Shyam Nagar, Off Jogeshwari-Vikhroli Link Road, Jogeshwari (East), Mumbai 400 060. T: +91 22 30841300 F: +91 22 66442201





This is to certify that **Mr./Ms. PUNITHA R** bearing *Register No. 18NCJC711*, B.Com final year student, **The National College, Autonomous, Jayanagar, Bangalore** has successfully completed a internship of six weeks (*from 27<sup>TH</sup> OCT to 10<sup>TH</sup> DEC 2020*) under the guidance of **MS. POOJASHREE R (COO)** at this organization, towards the fulfillment of award of "Bachelor of Commerce" during the year 2020 – 2021.

During the period of his internship, she has exhibited punctuality and diligence. We wish him/her every success in life.

Signature of the company authorized person  
(Chief operating officer)

Date: 10/12/2020  
Place: Bangalore.

PRINCIPAL  
The National College  
Jayanagar, Bangalore-70.



This is to certify that **Mr.RAJU.K** bearing Register No.**18NCJC641**.com Final Year Student , **THE NATIONAL COLLEGA ,Autonomous ,JayanagarBanglore** has Successfully Completed a internship of Seven weeks (from10-11-2020 to 24-12-2020) under the guidance of **Mr.Nithin ,Manager –HR** at the organization,toward the fulfillment of award of" bachelor of commerce" during the year 2020-2021

During the period of his intership he exhibited punctuality and diligen.we wish him every success in life.

Date: 24-12-2020

Place:Banglore

*Nithin*  
24/12/2020

Signature

Reliance Retail Ltd.  
Sarala Grand Hyper Mart  
CMC Khata No. 1402,  
Bilekahalli Village, Begur Hobli,  
Bannerghatta Main Road,  
BANGALORE - 560 076.

*S. Sush*

PRINCIPAL

The National College  
Jayanagar, Bangalore-70.





**Smitam®**

(A National NGO Registered Under Societies Registration Act of 1960)  
(Registration Year 2018-19, Registration No. JPN-4-00056-2018-19)  
No. 234 Doddakalasangra, Kanakapura Main Road, Bangalore 560062  
Phone No: +91 6366680903 Email: smitam.ngo@gmail.com

---

Date: 23/12/2020

This is to certify that **Mrs Raksha .R** bearing Register NO. **18NCJC712**, B.com final year student , **The National College , Autonomous , Jayanagar , Bengaluru** has successfully completed an internship from 9/11/2020 – 23/11/2020 , under the guidance of **Mrs MANDAARA HEBBAR BV** , Volunteer's management lead at the organization , towards the fulfillment of award of "Bachelor of commerce" during the year 2020-2021 .

During the period of her internship she exhibited punctuality and diligence . We wish her every success in life .

SMITAM  
No. 234, 50  
Kanakapura Main Rd  
BANGALORE - 560

Signature with seal

PRINCIPAL  
The National College  
Jayanagar, Bangalore-70.

Date: 23/12/2020

Place: Bengaluru





**CERTIFICATE**

This is to certify that **Mr. Rakshith M** bearing Register No. 18NCJC643, B Com Final year student of "The National College, Autonomous", Jayanagar, Bangalore has been Successfully completed an internship of six weeks from 26/10/2020 to 05/12/2020 under the guidance of Mr. Anand T(Manager) at the organization, towards the fulfillment of award of "Bachelor of Commerce" during the year 2020-2021.

During the period of his internship, he has exhibited punctuality and diligence.

We wish him every success in his future endeavors.

For Girias Investment Pvt Ltd

GIRIAS INVESTMENT PVT. LTD.  
No. 78, Kothriguppe Main Road,  
BCK 3rd Stage, Bangalore - 560085

Anand T  
(Manager)

Date: 10/12/2020  
Place: Bangalore

  
PRINCIPAL  
The National College  
Jayanagar, Bangalore-70.





**Sigma Networks**

*Technology Forcives*

# 362, 5th Main, Hampinagar, R.P.C. Layout  
Vijayanagar, Bangalore - 560 040.  
Ph : 080-23388652, 9620351959  
E-mail : accounts@sigmanetworks.co.in

This is to certify that **Mr. RANJAN T S** bearing Register No. **18NCJC645** ,  
B.Com final year student, **The National College, Autonomous**, Jayanagar,  
Bangalore has successfully completed a internship of seven weeks (from 12-  
10-2020 to 27-11-2020) under the guidance of **Mr. ANIL KUMAR**,  
MANAGER - HR at the organization, towards the fulfillment of award of  
"Bachelor of commerce" during the year 2020-2021.

During the period of his internship he exhibited punctuality and diligence. We  
wish him every success in life.

  
Signature

Date: 27-11-2020  
Place: Bangalore

  
PRINCIPAL  
The National College  
Jayanagar, Bangalore-70.



**TO WHOM SO EVER IT MAY CONCERN**

**22<sup>th</sup> December 2020**

This is to certify that **Ms. Roopa N**, bearing **Register No.18NCJC649**, **B.com final year student, The National College, Autonomous, Jayanagar, Bangalore** has successfully completed a internship of six weeks (from 07.11.2020 to 22.12.2020) under the guidance of **Nagaraj B N - Executive HR** at this organization, towards the fulfillment of award of "Bachelor of Commerce" during the Year 2020.

During the Period of her internship she has exhibited punctuality and diligence.

We wish her every success in life.

**For Metro cash and carry India Pvt. Ltd,**

  
**Udaya Kumar V**

**Department Manager- HR**



  
**PRINCIPAL**  
**The National College**  
**Jayanagar, Bangalore-70.**



**METRO**

Cash & Carry India

**YOUR SUCCESS IS OUR BUSINESS**



Ref: GRID / INTERNSHIP/2020

11<sup>th</sup> December, 2020

TO WHOMSOEVER IT MAY CONCERN

### CERTIFICATE

This is to certify that **R.Sheshadhari**, Reg No. 18NCJC655, Bcom final year student of The National College, Jayanagar, Autonomous, Jayanagar, Bangalore has successfully completed an Internship of six weeks from 28th Oct 2020 to 11th Dec 2020 under the guidance of Mrs. Vani S.P, HR Administration at "GRID R&D" BANGALORE towards the fulfilment of " Bachelor of Commerce" during the year 2020 - 2021

We found him punctual, agile and efficient.

We wish him prosperity in the posterity.

for GRID R & D

Vani S.P  
HR Administration

PRINCIPAL  
The National College  
Jayanagar, Bangalore-70.





**TEACHER TRAINING INSTITUTE OF INDIA**

**भारतीय शिक्षक प्रशिक्षण संस्थान**

( An ISO 9001:2008 Certified Institution, Recognized By Govt. of India )

Ref : .....

Date : 12/1/2021

Date: 12-1-2021

**TO WHOM IT MAY CONCERN**

This is to certify that **Mr Ruthvik L** Reg No:18NCJ650 a student of BCOM, National College Bangalore has successfully completed 45 days internship programme at Teacher's training institute of India. During the period of his internship programme with us he was found punctual, hardworking and inquisitive.

We wish him every success in life,



PRINCIPAL

The National College  
Jayanagar, Bangalore-70.



For Teacher Training Institute of India  
  
Authorized Signatory

**SIENNA ECAD Technologies Private Ltd.**

**CIN : U30007KA1997PTC022754**

# 775/A, 1<sup>st</sup> & 3<sup>rd</sup> Floor, 100 Feet Ring Road  
Banashankari 3<sup>rd</sup> Stage, Bangalore - 560 085, INDIA  
Tel: + 91-80-68190700, Fax: + 91-80-26426462

**4<sup>th</sup> December 2020**

## **CERTIFICATE OF INTERNSHIP**

This is to certify that **Mr. RUTHWIK RAMAKUMAR** bearing **Register No. 18NCJC713**, B.Com final year student, **The National College**, Autonomous, Jayanagar, Bangalore has successfully completed a internship of six weeks (from 5<sup>th</sup> October to 4<sup>th</sup> December 2020) under the guidance of **Mr. Mallesh**, Deputy Manager – Finance at this organization, towards the fulfillment of award of "Bachelor of Commerce" during the year 2020 — 2021.

During the period of his internship he has exhibited punctuality and diligence.

We wish him/her every success in life.

**For Sienna Ecad Technologies Pvt Ltd**

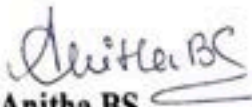
  
**Anitha BS**  
Deputy Manager - HR



  
**PRINCIPAL**  
**The National College**  
Jayanagar, Bangalore-70.







To,

Sachin Kumar K  
3<sup>rd</sup> year student  
National College  
**Bangalore**  
Email: [sachinkumar\\_123@gmail.com](mailto:sachinkumar_123@gmail.com)

DATE: 15 March 2021

Place: Bangalore

Dear Mr. Sachin Kumar K,

Subject: Offer Letter for Internship

As sited in the above subject, we are pleased to offer you the position of "Intern — Marketing" at ARKA Eduserve Pvt Ltd. Bangalore.

Please find the following confirmations of the specifics of your Internship.

- **Position Title:** Intern-Marketing
- **Start Date:** March 15, 2021
- **End Date:** April 13, 2021
- **Number of working hours :** 30 hours per week
- **Reporting Relationship/Supervisor:** You will be reporting to Mr. Rajiv BV, Head- Operations and Marketing of ARKA Eduserve Pvt LTD, Bangalore.  
Mr. Rajiv may be contacted by phone +919900080647 or by email; [Rajiv@jgischools.in](mailto:Rajiv@jgischools.in)

  
PRINCIPAL  
The National College  
Jayanagar, Bangalore-70.



ಸಂಸ್ಥೆ ಸಂವಹನ



ಬೆಂಗಳೂರು ನಗರ, ಬೆಂಗಳೂರು ಗ್ರಾಮಾಂತರ ಹಾಗೂ ರಾಮನಗರ  
ಜಿಲ್ಲಾ ಸಹಕಾರಿ ಹಾಲು ಉತ್ಪಾದಕ ಸಂಘಗಳ ಒಕ್ಕೂಟ ನಿಯಮಿತ, ಬೆಂಗಳೂರು-29



**Bengaluru Urban, Bengaluru Rural & Ramanagara  
District Co-operative Milk Producers' Societies Union Ltd., Bengaluru-29**

No.Bamul/Admn-10/cert/N-38/2020-21

Date:05.02.2021

**CERTIFICATE**

This is to certify that Ms.Sai Shree.M.R, Reg.No.18NCJC652,  
Student of The National College Studies B.com part of  
Curriculum has undertaken project entitled as "Organisation  
Study" at Bengaluru Urban, Bengaluru Rural and Ramanagara  
District Co-operative milk producer's Societies Union Ltd., during  
10.11.2020 to 10.12.2020.

  
General Manager(Admn)  
Bengaluru Co-op Milk Union Ltd.,

  
PRINCIPAL  
The National College  
Jayanagar, Bangalore-70.





25/02/2021

# TIAN E DIE CASTING & ENGINEERING

TO WHOMSOEVER IT MAY CONCERN

TO: Mr. Sandeep A. (15/12/2020) TIAN E. ALP

This is to certify that **Mr. Sandeep A.** a student of B.Com National Degree collage Jayanagar has successfully completed 45 Days (from 15<sup>th</sup> Dec 2020 to 29<sup>th</sup> January 2021) internship program at this company

During his employment with us we have found him to be sincere and hardworking with good integrity

We wish him all the best for his future endeavors.

Thanking you

Yours sincerely  
For TIAN E DIE-CASTING AND ENGINEERING

  
Gopinath B.N  
Human Resource

  
PRINCIPAL  
The National College  
Jayanagar, Bangalore-70.





ZERO MICROFINANCE & SAVINGS SUPPORT Pvt Ltd .  
STATE HEAD OFFICE  
#17, GROUND FLOUR , SHIVASHAKTHI NAGAR, CHUNCHAGATTA MAIN  
ROAD, NEAR GREEN VALLEY SCHOOL, BANGLORE-560062  
Mobile no : 9448487705



DATE : 03-03-2020

To.  
**Head of Department**  
NATIONAL DEGREE COLLEGE  
JAYANAGAR, BANGLORE – 560070

Dear Sir/Madam

SUBJECT : Internship letter of Mr. **SANJAY . B (18NCJC693)**

This is to certify that **SANJAY. B (18NCJC693)** has joined our Organization on 03 March 2021 and will be working as internship trainee in Accounts and Finance department in our Zero Micro Finance & Savings Support Pvt. Ltd for the period of 30 days.

Zero Micro Finance & Savings Support Pvt. Ltd .

  
Bangalore Area Manager

  
PRINCIPAL  
The National College  
Jayanagar, Bangalore-70.





ITC Limited  
INDIA TOBACCO DIVISION  
Meenakunte Village  
Jala Hobli  
Bengaluru (North) - 562 157  
INDIA  
Tel : 0091 - 80-28467709/10/11/13/14/15  
Fax : 0091 - 80-28467707

December 18, 2020

**TO WHOMSOEVER IT MAY CONCERN**

This is to certify that Mr. Sanjay B.G, of The National College, Bengaluru bearing Reg. No. 18NCJC731 has successfully completed an "Organisation Study" at ITC Limited, Bengaluru Factory from 21<sup>st</sup> October, 2020 to 04<sup>th</sup> December, 2020.

He has done this Study under the guidance of Ms. Sruthi Sainath of HR Department.

He has completed this Study to the satisfaction of all concerned.

We wish him all the best in his future endeavours.

ITC LIMITED

**HUMAN RESOURCES MANAGER**



PRINCIPAL  
The National College  
Jayanagar, Bangalore-70.



Dated: 12<sup>th</sup> March 2021

## To whomsoever it may concern

This is to certify that **Mr. Shashank B S** bearing register no. **18NCJC694** B.Com final year student, The National College, Autonomous, Jayanagar, Bangalore has successfully completed an internship of six weeks (from **12.10.2020** to **04.12.2020**) under the guidance of **Mr Pawan Khemka** at our organization, towards the fulfillment of award of "Bachelor of Commerce" during the year 2020-2021.

The topic of his internship was "**Accounting, Financial Consulting and Audit**"

During the period of his internship he has exhibited punctuality and diligence. We wish him every success in life.

For, Choice Consultancy Services Private Limited



Neha Jain

Authorized Signatory

  
PRINCIPAL  
The National College  
Jayanagar, Bangalore-70.



### **Choice Consultancy Services Private Limited**

Choice House, Shree Shakambhari Corporate Park, Plot No 156-158, J.B. Nagar, Andheri (East), Mumbai - 400 099. CIN No. U72900MH2010PTC196603  
Tel.: +91-22-6707 9999 Telefax.: +91-22-6707 9859 E-mail Id.: info@choiceindia.com Website.: www.choiceindia.com



**CERTIFICATE**  
**TO WHOM SO EVER IT MAY CONCERN**

This is to certify that **Mr. SHASHANK. M** (REG: 18NCJC695) from NATIONAL COLLEGE ,JAYANAGAR BANGLORE, he has successfully completed his Internship/Project training starting from **05-10-2020 to 25-11-2020[ 45 days]** the project titled **“STUDY ON CASHFLOW STATEMENT AT PRABHUDAS LILLADHER PVT LTD, Bangalore”**.

On completion of the project, he has submitted a report of the above studies.

We wish all the best for his future Endeavour's.

DATE: 28-11-2020

PLACE: BANGALORE

  
SIGNATURE



  
PRINCIPAL  
The National College  
Jayanagar, Bangalore-70.

**Prabhudas Lilladher Pvt. Ltd.**

Regd. Office: 3rd Floor, Sadhana House, 570, P.B.Marg, Worli, Mumbai - 400 018. Tel: + 91 22 6632 2222 | Fax: + 91 22 6632 2229  
CIN: U67190MH1983PTC028670 Compliance Officer: **Mr. A. Subrahmanian** | Email: asubrahmanian@plindia.com

SEBI REGN No. BSE (Cash/F&O) INB/F 010502855, NSE (Cash/F&O/Currency Derivatives) INB/F/E 230597738  
CDSL IN DP-CDSL 14 99, DP ID 12011300 NSDL IN DP-NSDL 329 2010, DP ID IN303868, PMS INP000001231, AMFI ARN 3276

This is certify that Miss. **SHILPA S** bearing Register No. **18NCJC696**, B.Com final year student, **THE NATIONAL COLLEGE, AUTONOMOUS**, Jayanagar, Bangalore has successfully completed a internship of six weeks (from 14-10-2020 to 28-11-2020) under the guidance of **Mr. MANJUNATH CHARY, Accounts Manager** at the organization, towards the fulfillment of award of "Bachelor of commerce" during the year 2020-2021.

During the period of her internship she exhibited punctuality and diligence. We wish her every success in life.



Date: 28-11-2020

Place: Bangalore



  
PRINCIPAL  
The National College  
Jayanagar, Bangalore-70.

ಬೆಂಗಳೂರು ನಗರ, ಬೆಂಗಳೂರು ಗ್ರಾಮಾಂತರ ಹಾಗೂ ರಾಮನಗರ ಜಿಲ್ಲಾ ಸರ್ಕಾರ  
ಹಾಲು ಉತ್ಪಾದಕರ ಸಂಘಗಳ ಒಕ್ಕೂಟ ನಿಯಮಿತ, ಬೆಂಗಳೂರು ಡೇರಿ ಪ್ರಾಂಗಣ,  
ಡಾ ಎಂ.ಹೆಚ್.ಮರೀಗೌಡ ರಸ್ತೆ ಡಿ.ಆರ್.ಕಾಲೇಜ್ ಅಂಚೆ, ಬೆಂಗಳೂರು-560029.

ಟಿಪ್ಪಣಿ:-

ದಿನಾಂಕ:- 13/03/2021

ವಿಷಯ:- PROJECT WORK ಮಾಡಿರುವ ವಿದ್ಯಾರ್ಥಿಯ ಹಾಜರಾತಿ ದೃಢೀಕರಣ ನೀಡುವ ಬಗ್ಗೆ.

ಉಲ್ಲೇಖ:-

ಈ ಮೇಲ್ಕಂಡ ವಿಷಯಕ್ಕೆ ಸಂಬಂಧಿಸಿದಂತೆ Shiva Poasad. R.

ಇವರು ದಿನಾಂಕ:- 13/11/2020 ರಿಂದ 13/12/2020 ರ ವರೆಗೆ PROJECT WORK

ಮಾಡಲು ಅನುಮತಿ ಪಡೆದು ಈ ಅವಧಿಯಲ್ಲಿ ಒಟ್ಟು 20 days

ದಿನಗಳು ಹಾಜರಾಗಿ ಭದ್ರತಾ ದಾಖಲಾತಿಯಲ್ಲಿ ಸಹಿಯನ್ನು ಮಾಡಿರುತ್ತಾರೆ. ಈ ಮಾಹಿತಿಯನ್ನು ತಮ್ಮ ಗಮನಕ್ಕೆ ತಂದು ಮುಂದಿನ ಕ್ರಮಕ್ಕಾಗಿ ಒಪ್ಪಿಸಿದೆ.

  
PRINCIPAL  
The National College  
Jayanagar, Bangalore-70.



  
ಮಹಾ ಮೈಲ್ಕುಪ್ಪುರಸ್ಕರಣಾಧಿಕಾರಿಗಳು  
ಬೆಂಗಳೂರು ಹಾಲು ಉತ್ಪಾದಕರ  
ಸಂಘದವರು-560 029



# Karnataka Plastoo Industries (P) Ltd.

ADMN. OFF. & FACTORY :

# 110/E & F, Bommasandra Industrial Area, Hebbagodi Village, BANGALORE - 560 099

Phone : 2783 2459 / 2783 2460 / 4165 8088 / 41658089 Fax : 2783 6461

Email : accounts@kplastooind.com / ceo@kplastooind.com

CIN NO. : U25200KA1971PTC002098



This is certify that Miss. **SINDHU K** bearing Register No. **18NCJC698**, B.COM final year student, **THE NATIONAL COLLEGE, AUTONOMOUS, JAYANAGAR**, Bangalore has successfully completed a internship of six weeks (from 01-10-2020 to 14-11-2020) under the guidance of **Mr. SUDHRASAN S., Accounts Officer** of the organization, towards the fulfilment of award of "Bachelor of commerce" during the year 2020-2021.

During the period of her internship she exhibited punctuality and diligence. We wish her every success in life.

Signature

Date: 16-11-2020

Place: Bangalore

For Karnataka Plastoo Industries (P) Ltd

Authorized Signatory

9/24/30/16/18



*S. Sudy*  
PRINCIPAL  
The National College  
Jayanagar, Bangalore-70.



Regd. Off : Rajanna Lane, Ganigarpel, Nagarthpet Cross, Bangalore - 560 002

H.O # 270, Bommanahalli, Bangalore - 560 068

Phone : 25732440 41316028, Fax : 25732610 email : bommanahalli@kplastooind.com

# VSS VSS INNOVATIVE TECHNOLOGIES

For enquiry Call : 77958 51053 / 88928 49980

## TO WHOM IT MAY CONCERN

This is to certify that Ms. SNEHA R bearing Register No. 18NCJC699 student of B.com Final Year, The National College (Autonomous), Jayanagar, Bangalore worked as an intern at VSS Innovative Technologies, Bangalore from 12 October 2020 to 27 November 2020 on the internship program titled **Bachelor of Commerce**. During the tenure here, she worked hard and delivered the assigned work at the stipulated time. VSS Innovative Technologies wishes all success in her career.

VSS Innovative Technologies

  
27/11/20



Authorized Signatory

  
PRINCIPAL  
The National College  
Jayanagar, Bangalore-70.





This is to certify that **Mr./Ms. SPURTHI K G BHAT** bearing *Register No. 18NCJC729*, B.Com final year student, **The National College, Autonomous**, Jayanagar, Bangalore has successfully completed a internship of six weeks (*from 9<sup>TH</sup> NOV 2020 to 26<sup>TH</sup> DEC 2020*) under the guidance of **MS. POOJASHREE R (COO)** at this organization, towards the fulfillment of award of "Bachelor of Commerce" during the year 2020 – 2021.

During the period of his internship, she has exhibited punctuality and diligence. We wish him/her every success in life.

Signature of the company authorized person  
(Chief operating officer)

Date: 26/12/2020

Place: Bangalore.

PRINCIPAL

The National College  
Jayanagar, Bangalore-70.







This is to certify that **Mr./Ms. SPURTHI K G BHAT** bearing *Register No. 18NCJC729*, B.Com final year student, **The National College, Autonomous**, Jayanagar, Bangalore has successfully completed a internship of six weeks (*from 9<sup>TH</sup> NOV 2020 to 26<sup>TH</sup> DEC 2020*) under the guidance of **MS. POOJASHREE R (COO)** at this organization, towards the fulfillment of award of "Bachelor of Commerce" during the year 2020 – 2021.

During the period of his internship, she has exhibited punctuality and diligence. We wish him/her every success in life.

Signature of the company authorized person  
(Chief operating officer)

Date: 26/12/2020

Place: Bangalore.

PRINCIPAL

The National College  
Jayanagar, Bangalore-70.



# ROYAL INDRAPRASTHA RESTAURANT

---

Date : 12-03-2021

## CERTIFICATE

This Is To Certify That Mr Srinivasa V Reg No. 18ncjc657,  
Student Of The National Collage Studies B.com Part Of  
Curriculum Has Undertaken Project Entitled As "organisation Study"  
At Royal Indraprastha Restaurant 06/11/2020 To 21/12/2020.

  
PRINCIPAL  
The National College  
Jayanagar, Bangalore-70.



ROYAL INDRAPRASTHA RESTAURANT

  
Authorized Signatory

# ROYAL INDRAPRASTHA RESTAURANT

Date : 12-03-2021

## CERTIFICATE

This Is To Certify That Mr Sunil Kumar C Reg No. 18ncjc658,  
Student Of The National Collage Studies B.com Part Of  
Curriculum Has Undertaken Project Entitled As "organisation Study"  
At Royal Indraprastha Restaurant 06/11/2020 To 21/12/2020.

  
PRINCIPAL  
The National College  
Jayanagar, Bangalore-70.



ROYAL INDRAPRASTHA RESTAURANT

  
Authorized Signatory



17<sup>th</sup> April, 2021

TO WHOMSOEVER IT MAY CONCERN

CERTIFICATE

This is to certify that Ms. Sushmitha B.S student of National College, Jayanagar Autonomous has successfully completed Internship in the department of Human Resources from 17 March 2021 to 16 April 2021. During her period of stay with us, we found her to be dedicated, hardworking, loyal and sincere.

We wish her all the best for her future endeavors.

  
PRINCIPAL  
The National College  
Jayanagar, Bangalore-70.

For Apollo Hospitals, Bangalore

(A unit of Apollo enterprise Limited)

  
17/4/21

Ms Ramya Rai

Senior Manager - Human Resources





# Sigma Networks

*Technology Forever*

# 362, 5th Main, Hampinagar, R.P.C. Layout  
Vijayanagar, Bangalore - 560 040.  
Ph : 080-23388652, 9620351959  
E-mail : accounts@sigmanetworks.co.in

This is to certify that **Mr. THEJUS.P** bearing Register No. **18NCJC702** ,  
B.Com final year student, **The National College, Autonomous**, Jayanagar,  
Bangalore has successfully completed a internship of seven weeks (from 12-  
10-2020 to 27-11-2020) under the guidance of **Mr. ANIL KUMAR**,  
MANAGER - HR at the organization, towards the fulfillment of award of  
"Bachelor of commerce" during the year 2020-2021.

During the period of his internship he exhibited punctuality and diligence. We  
wish him every success in life.



Signature

Date: 27-11-2020  
Place: Bangalore



PRINCIPAL  
The National College  
Jayanagar, Bangalore-70.





# ಕರ್ನಾಟಕ ಸಾಬೂನು ಮತ್ತು ಮಾರ್ಜರ್ ನಿಯಮಿತ

(ಕರ್ನಾಟಕ ಸರ್ಕಾರದ ಸ್ವಾಮ್ಯಕ್ಕೆ ಒಳಪಟ್ಟಿದೆ)

## Karnataka Soaps & Detergents Limited

(A Government of Karnataka Undertaking)



KSDL/HRD/59[C]-A/20-21/ /

Date: 31.12.2020

### CERTIFICATE

This is to certify that **Ms.Vachana Sunderraj**, Reg No. 18NCJC662 Student of B.com. The National College, Autonomous, Jayanar, Bengaluru-560070. Has done Internship on "**Organizational Study**" at Karnataka Soaps & Detergents Limited, Bengaluru-560055, from: 09.11.2020 to 23.12.2020.

During her Internship in our Company, her performance & Conduct is good.

We wish her success in Life and Career.

  
**PRINCIPAL**  
 The National College  
 Jayanagar, Bangalore-70.



  
**ASST.GENERAL MANAGER**  
 [Human Resource & Development]

Karnataka Soaps & Detergents Limited  
 # 27, Industrial Suburb,  
 Bengaluru-Pune Highway,  
 Rajajinagar, Bengaluru-560 055



This is to certify that **Mr. Vaibhav Puranik** bearing Register **No.18NCJC730**, B.Com final year student, **The National College, Autonomous**, Jayanagar, Bangalore has successfully completed a internship of six weeks (from 02/11/2020.to 16/12/2020) under the guidance of **Mr. Nagaraja & Assistant Manager- Accounts** at this organization, towards the fulfillment of award of "Bachelor of Commerce" during the year 2020 – 2021.

During the period of his internship, he has exhibited punctuality and diligence. We wish him/her every success in life.

For **DynPro India Pvt Ltd**



Authorized Signatory

Nagaraja

Assistant Manager-Accounts

Date: 16/12/2020

  
PRINCIPAL  
The National College  
Jayanagar, Bangalore-70.

10th January 2021

To whomsoever it may concern

This is to certify that Mr.Vaibhav.V bearing Register No.18NCJC715, B.Com final year student, The National College, Autonomous, Jayanagar, Bangalore has successfully completed a internship of Six weeks from 16th November 2020 to 6th January 2021 under the guidance of Mrs. Leelavathi.N HR at this organization, towards the fulfillment of award of "Bachelor of Commerce" during the year 2020-2021.

During the period of his internship he has exhibited punctuality and diligence. We wish him every success in his life.

Thanking you,

Yours truly,

  
Leelavathi.N  
HR Manager

  
PRINCIPAL

The National College  
Jayanagar, Bangalore-70.



Ref No: MSPL15052021

Date: 15/05/2021

**TO WHOM IT MAY CONCERN**

To,  
**MS. VANISHREE.M**  
(Interns)

**Sub: Experience Letter**

It is to certify that **MS.Vanishree.M** was working as Interns with us as interns from period **08<sup>th</sup> March, 2021 to 07<sup>th</sup> April 2021** as per the **Marketonix's** employment record.

During her employment **MS.Vanishree.M** has perused knowledge & experience in our organization.

During her period, we found her to be Professional, knowledgeable and result oriented with theoretical & practical understanding of work requirements.

Overall she performed her duties and responsibilities cheerfully with attention to detail at all times. With her enthusiasm to work, learn and progress, I am certain that she would make a great employee to any enterprise.

For, **Marketonix Services Private Limited.**

Yours Sincerely,

HR TEAM  
**MARKETONIX SERVICES PRIVATE LIMITED**



*[Handwritten Signature]*  
PRINCIPAL  
**The National College**  
Jayanagar, Bangalore-70.





# SHRI VISHKARMA INTERIOR

We undertake *turn key* project of Interiors

Mob : 9008133225

: 9448089049

30, (S.82/1), Jai Hanuman Nagar, Near Divya Jyothi School, Arekere Village, Bannerghatta Road, Bangalore - 560076

## INTERNSHIP CERTIFICATE

This is to certify that **Mr. VENKATESH T** bearing **Register No.18NCJC716**, B.Com final year student, **The National College, Autonomous**, Jayanagar, Bangalore has successfully completed an internship of six weeks (from 04/11/2020 to 18/12/2020) under the guidance of **Mr. UKMARAM – Finance Manager** at this organization, towards the fulfillment of award of “Bachelor of Commerce” during the year 2020 – 2021.

During the period of his internship he has exhibited punctuality and diligence. We wish him every success in life.

For SHRI VISHKARMA INTERIOR

  
Proprietor/Authorized Signature

Signature and Seal of the company authorized person or head

Date: 21/12/2020

Place: Bengaluru



  
PRINCIPAL  
The National College  
Jayanagar, Bangalore-70.



**Youth for seva™**  
experience the joy of giving



# Certificate of Internship

Dear Vijay Kumar V

from The National College Jayanagar

Youth for Seva congratulates you for your endearing and committed service as an Intern.

For Projects Employability Skills Mentorship Program

Duration 08/11/2020 to 23/12/2020

Happy Volunteering!

*[Signature]*  
PRINCIPAL  
The National College  
Jayanagar, Bangalore-70.



DATE : December 2020

*[Signature]*  
FOUNDER & EXECUTIVE DIRECTOR

This is certify that Mr. **VINOD KUMAR S** bearing Register No. **18NCJC703**, B.Com final year student, **THE NATIONAL COLLEGE, AUTONOMOUS**, Jayanagar, Bangalore has successfully completed a internship of six weeks (from 14-10-2020 to 28-11-2020) under the guidance of **Mr. GANGA BABU**, Operational Manager at the organization, towards the fulfillment of award of "Bachelor of commerce" during the year 2020-2021.

During the period of him internship he exhibited punctuality and diligence. We wish him every success in life.



Date: 28-11-2020

Place: Bangalore



  
PRINCIPAL  
The National College  
Jayanagar, Bangalore-70.



This is to certify that Mr. VINYAS. B. S bearing Register No. 18NCJC704, B.Com final year student, The National College, Autonomous, Jayanagar, Bangalore has successfully completed a internship of six weeks from 26<sup>th</sup> November 2020 to 28<sup>th</sup> December 2020 under the guidance of Mr. Shridhar – Sole proprietor at this organization, towards the fulfillment of award of "bachelor of commerce" during the year 2020 – 2021.

During the period of his internship, he has exhibited punctuality and diligence.

We wish him every success in life.



Date: 21/01/2021

Place: Bangalore

*Dr. Sridhar*  
PRINCIPAL  
The National College  
Jayanagar, Bangalore-70.



Ref: GRID / INTERNSHIP/2020

11<sup>th</sup> December, 2020

**TO WHOMSOEVER IT MAY CONCERN**

CERTIFICATE

This is to certify that **A. Vishnu**, Reg No. 18NCJC666, Bcom final year student of The National College, Jayanagar, Autonomous, Jayanagar, Bangalore has successfully completed an Internship of six weeks from 28th Oct 2020 to 11th Dec 2020 under the guidance of Mrs. Vani S.P, HR Administration at "GRID R&D" BANGALORE towards the fulfillment of " Bachelor of Commerce" during the year 2020 - 2021

We found him punctual, agile and efficient.

We wish him prosperity in the posterity.

for GRID R & D

Vani S.P  
HR Administration

PRINCIPAL  
The National College  
Jayanagar, Bangalore-70.





## INTERNSHIP OFFER LETTER

March 10, 2021

Mr. Adithya Parashar K C  
Department of Computer Science,  
National College (Autonomous),  
7<sup>th</sup> Block, Jayanagar, Bengaluru - 70

Dear Adithya Parashar K C,

We would like to congratulate you on being selected for the **Trainee Software Engineer** Internship position with **Renalyx Health Systems Pvt. Ltd, Bengaluru**, effective from March 10, 2021. This internship will be duration of 4 months.

As we discussed during the interview process, this is a non-paid internship.

This internship is viewed by the organization as being an opportunity for you to learn and explore yourself as academic project, rather than a part-time job. As such, your internship will include training/orientation and focus primarily on learning and developing new skills and gaining a deeper understanding of concepts through hands-on application of the knowledge you learned already.

During the internship period you will be accessible for the confidential resources or the documents of the organization. By accepting this offer, you should adhere to the policies and confidentiality of the organization. You are not supposed to disclose any of this confidential resources with the outside world.

You will be working for a project entitled "**Patient disease management system**" and place of work will be in the Bengaluru location. You will be reporting to the head of software team.

You will be issued letter after successful completion of internship. But this letter will not guarantee any employment in Renalyx.

Again, congratulations and we look forward to working with you.

With Best Wishes

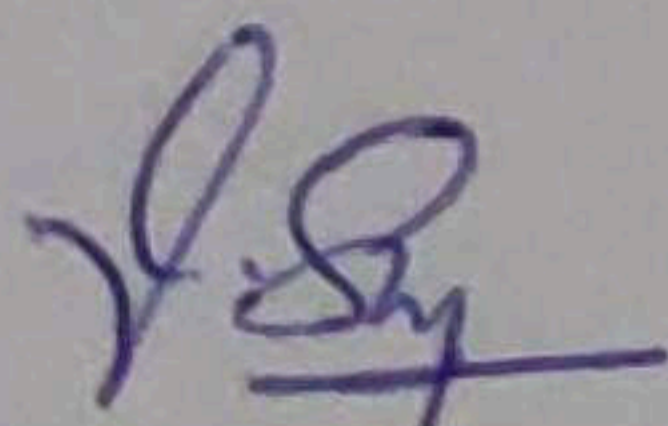

Dr. Shyam Vasudevarao

Director

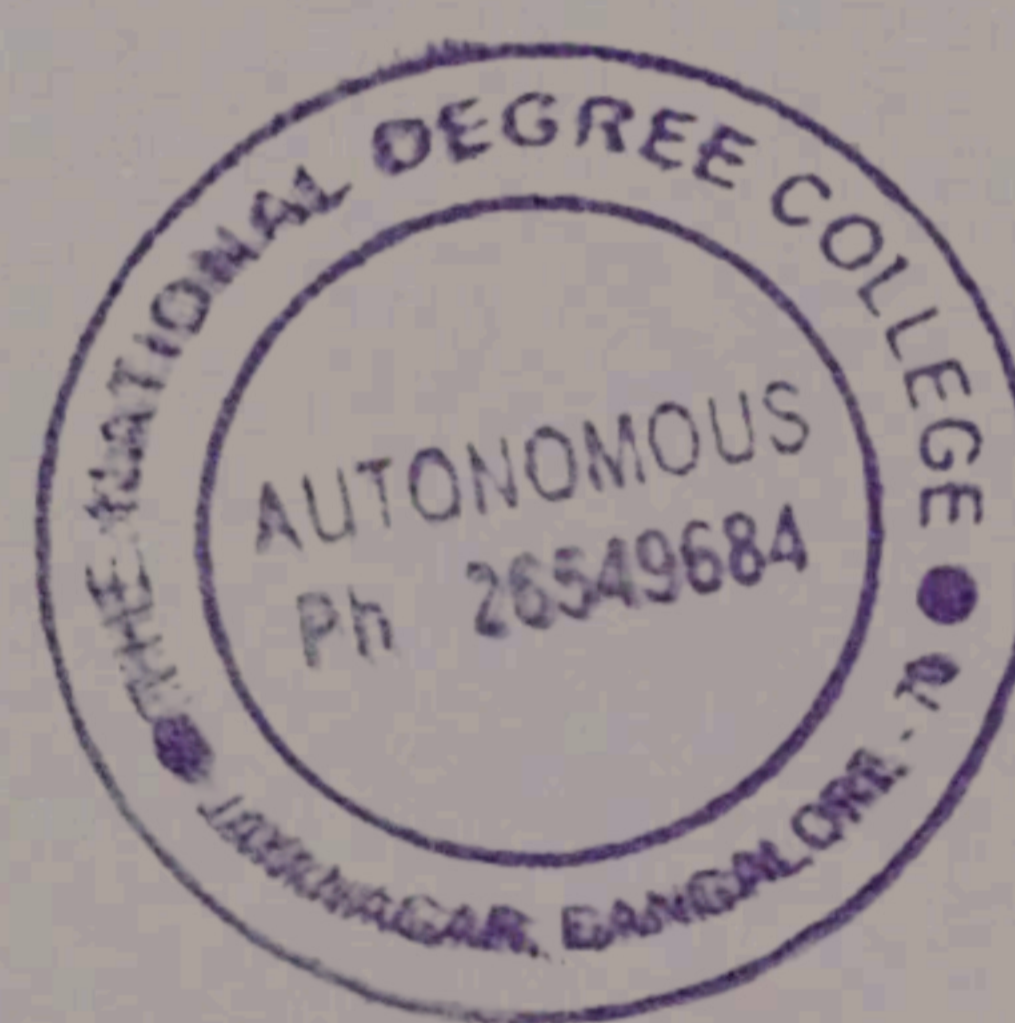

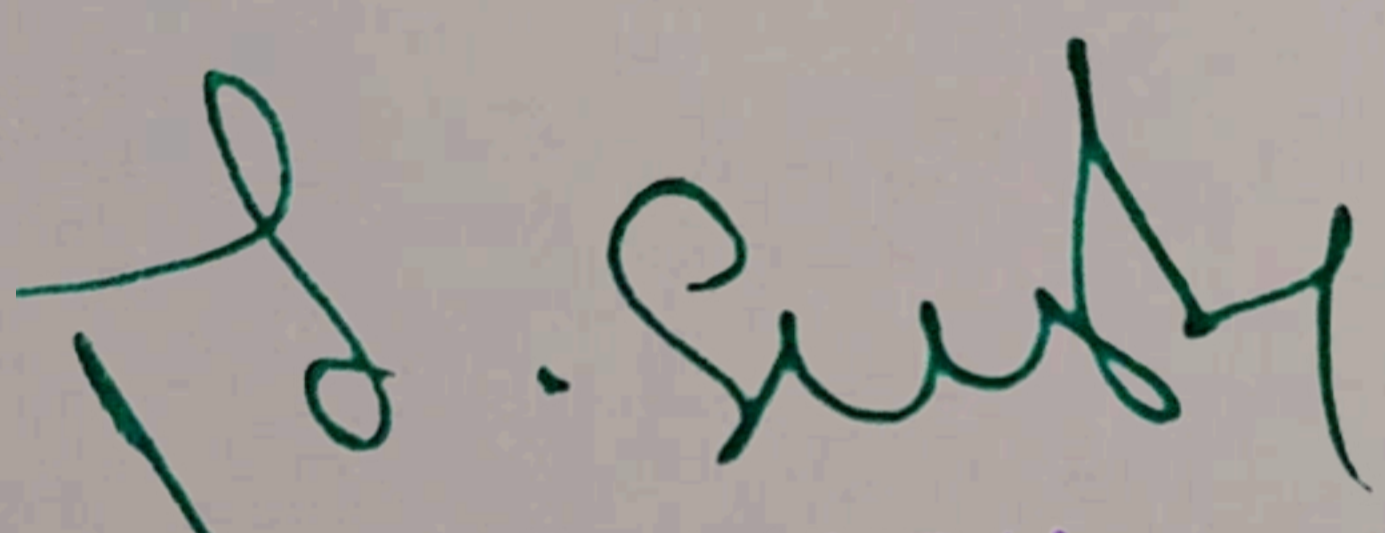
  
PRINCIPAL  
The National College  
Jayanagar, Bangalore-70

**Renalyx Health Systems Private Limited.,**



## INTERNSHIP OFFER LETTER

March 10, 2021

Mr. Karthik  
Department of Computer Science,  
National College (Autonomous),  
7<sup>th</sup> Block, Jayanagar, Bengaluru - 70

Dear Karthik,

We would like to congratulate you on being selected for the **Trainee Software Engineer** Internship position with **Renalyx Health Systems Pvt. Ltd, Bengaluru**, effective from March 10, 2021. This internship will be duration of 4 months.

As we discussed during the interview process, this is a non-paid internship.

This internship is viewed by the organization as being an opportunity for you to learn and explore yourself as academic project, rather than a part-time job. As such, your internship will include training/orientation and focus primarily on learning and developing new skills and gaining a deeper understanding of concepts through hands-on application of the knowledge you learned already.

During the internship period you will be accessible for the confidential resources or the documents of the organization. By accepting this offer, you should adhere to the policies and confidentiality of the organization. You are not supposed to disclose any of this confidential resources with the outside world.

You will be working for a project entitled "**Patient disease management system**" and place of work will be in the Bengaluru location. You will be reporting to the head of software team.

You will be issued letter after successful completion of internship. But this letter will not guarantee any employment in Renalyx.

Again, congratulations and we look forward to working with you.

With Best Wishes

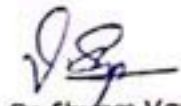

Dr. Shyam Vasudevarao

Director



  
PRINCIPAL  
The National College  
Jayanagar, Bangalore-70.

**Renalyx Health Systems Private Limited.,**

CIN: U74140KA2012PTC066472 | Phone: +91 9380345062. <http://www.renalyx.com>  
No.19, 2<sup>nd</sup> Floor, South End road, Basavanagudi, Bengaluru - 560004 India.

## INTERNSHIP OFFER LETTER

March 10, 2021

Ms. Neha V  
Department of Computer Science,  
National College (Autonomous),  
7th Block, Jayanagar, Bengaluru - 70

Dear Neha V,

We would like to congratulate you on being selected for the **Trainee Software Engineer** Internship position with **Renalyx Health Systems Pvt. Ltd, Bengaluru**, effective from March 10, 2021. This internship will be duration of 4 months.

As we discussed during the interview process, this is a non-paid internship.

This internship is viewed by the organization as being an opportunity for you to learn and explore yourself as academic project, rather than a part-time job. As such, your internship will include training/orientation and focus primarily on learning and developing new skills and gaining a deeper understanding of concepts through hands-on application of the knowledge you learned already.

During the internship period you will be accessible for the confidential resources or the documents of the organization. By accepting this offer, you should adhere to the policies and confidentiality of the organization. You are not supposed to disclose any of this confidential resources with the outside world.

You will be working for a project entitled "**Patient disease management system**" and place of work will be in the Bengaluru location. You will be reporting to the head of software team.

You will be issued letter after successful completion of internship. But this letter will not guarantee any employment in Renalyx.

Again, congratulations and we look forward to working with you.

With Best Wishes



Dr. Shyam Vasudevarao

Director



  
PRINCIPAL  
The National College  
Jayanagar, Bangalore-70.



**Renalyx Health Systems Private Limited.,**



## INTERNSHIP OFFER LETTER

March 10, 2021

Mr. Praneeth M S  
Department of Computer Science,  
National College (Autonomous),  
7<sup>th</sup> Block, Jayanagar, Bengaluru - 70

Dear Praneeth M s,

We would like to congratulate you on being selected for the **Trainee Software Engineer** Internship position with **Renalyx Health Systems Pvt. Ltd, Bengaluru**, effective from March 10, 2021. This internship will be duration of 4 months.

As we discussed during the interview process, this is a non-paid internship.

This internship is viewed by the organization as being an opportunity for you to learn and explore yourself as academic project, rather than a part-time job. As such, your internship will include training/orientation and focus primarily on learning and developing new skills and gaining a deeper understanding of concepts through hands-on application of the knowledge you learned already.

During the internship period you will be accessible for the confidential resources or the documents of the organization. By accepting this offer, you should adhere to the policies and confidentiality of the organization. You are not supposed to disclose any of this confidential resources with the outside world.

You will be working for a project entitled "**Patient disease management system**" and place of work will be in the Bengaluru location. You will be reporting to the head of software team.

You will be issued letter after successful completion of internship. But this letter will not guarantee any employment in Renalyx.

Again, congratulations and we look forward to working with you.

With Best Wishes



Dr. Shyam Vasudevarao

Director



  
PRINCIPAL  
The National College  
Jayanagar, Bangalore-70.



**Renalyx Health Systems Private Limited.,**



## INTERNSHIP OFFER LETTER

March 10, 2021

Ms. Rakshitha M  
Department of Computer Science,  
National College (Autonomous),  
7<sup>th</sup> Block, Jayanagar, Bengaluru - 70

Dear Rakshitha M,

We would like to congratulate you on being selected for the **Trainee Software Engineer** Internship position with **Renalyx Health Systems Pvt. Ltd, Bengaluru**, effective from March 10, 2021. This internship will be duration of 4 months.

As we discussed during the interview process, this is a non-paid internship.

This internship is viewed by the organization as being an opportunity for you to learn and explore yourself as academic project, rather than a part-time job. As such, your internship will include training/orientation and focus primarily on learning and developing new skills and gaining a deeper understanding of concepts through hands-on application of the knowledge you learned already.

During the internship period you will be accessible for the confidential resources or the documents of the organization. By accepting this offer, you should adhere to the policies and confidentiality of the organization. You are not supposed to disclose any of this confidential resources with the outside world.

You will be working for a project entitled "**Patient disease management system**" and place of work will be in the Bengaluru location. You will be reporting to the head of software team.

You will be issued letter after successful completion of internship. But this letter will not guarantee any employment in Renalyx.

Again, congratulations and we look forward to working with you.

With Best Wishes

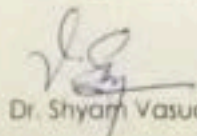

Dr. Shyam Vasudevarao

Director



  
PRINCIPAL  
The National College  
Jayanagar, Bangalore-70.



Renalyx Health Systems Private Limited.

## INTERNSHIP OFFER LETTER

March 10, 2021

Ms Sainirupama  
Department of Computer Science,  
National College (Autonomous),  
7<sup>th</sup> Block, Jayanagar, Bengaluru - 70

Dear Sainirupama,

We would like to congratulate you on being selected for the **Trainee Software Engineer** Internship position with **Renalyx Health Systems Pvt. Ltd, Bengaluru**, effective from March 10, 2021. This internship will be duration of 4 months.

As we discussed during the interview process, this is a non-paid internship.

This internship is viewed by the organization as being an opportunity for you to learn and explore yourself as academic project, rather than a part-time job. As such, your internship will include training/orientation and focus primarily on learning and developing new skills and gaining a deeper understanding of concepts through hands-on application of the knowledge you learned already.

During the internship period you will be accessible for the confidential resources or the documents of the organization. By accepting this offer, you should adhere to the policies and confidentiality of the organization. You are not supposed to disclose any of this confidential resources with the outside world.

You will be working for a project entitled "**Patient disease management system**" and place of work will be in the Bengaluru location. You will be reporting to the head of software team.

You will be issued letter after successful completion of internship. But this letter will not guarantee any employment in Renalyx.

Again, congratulations and we look forward to working with you.

With Best Wishes



Dr. Shyam Vasudevarao

Director



  
PRINCIPAL  
The National College  
Jayanagar, Bangalore-70.



**Renalyx Health Systems Private Limited.,**



# SAPNE

Secure The Childs Future



Date: 09/08/2020

This certificate is presented to: GurunagaNandan. N

For your dedication to your profession in the department  
and for being the "BEST INTERN".

MASS COMMUNICATION

CERTIFICATE  
OF  
APPRECIATION

  
Signature

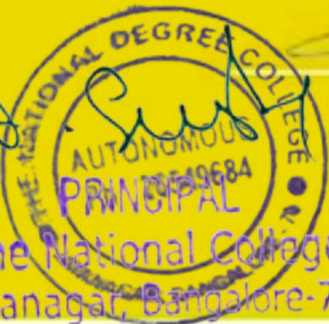

The National College  
Jayanagar, Bangalore-70





Jayant Murthy  
The Indian Institute of Astrophysics  
Koramangala  
Bangalore 560034  
India

E-mail: [jmurthy@yahoo.com](mailto:jmurthy@yahoo.com)  
Mobile: (91)9844044228  
Off: (91)(80)25539250x263  
FAX: (91) (80) 25534043  
<http://www.iia.res.in/personnel/murthy/index.htm>

PG coordinator,  
Department of Postgraduate  
studies and research in Physics

Jul 11, 2018

I am pleased to offer a project entitled "Analysis of the ultraviolet sky from spacecraft data" to:

- 1) Mounica K.
- 2) Abishek P.
- 3) Shankar SA

I look forward to working with the students in this exciting project.

Sincerely

*Jayant Murthy*

Jayant Murthy  
Senior Professor

*D. Suresh*

PRINCIPAL  
The National College  
Jayanagar, Bangalore-70.



ಇ/ಮಾ.ಸಂ./ಪರಿಯೋಜನೆ/2018/ E/HR/Project/2018

25-08-2018

The National College  
BENGALURU.

ಮಹೋದಯ/Dear Sir/ಮಹೋದಯ/Madam,

**ವಿಷಯ : ವೇತನ ರಹಿತ ನಿ:ಶುಲ್ಕ ಕೆ ಆಧಾರ ಪರ ಪ್ರಶಿಕೃತಾ ।**

**Sub: Internship on No-Pay-No-Fee-Basis.**

ಉಪಯುಕ್ತ ವಿಷಯ ಪರ ವೇತನ ರಹಿತ ನಿ:ಶುಲ್ಕ ಕೆ ಆಧಾರ ಪರ M.Sc ( Physis) ಕೆ ವಿದ್ಯಾರ್ಥಿ ಕೆ ಲಿಪಿ ಪ್ರಶಿಕೃತಾ ಹೆತು ಅನುರೂಪ ಕರತೆ ಹು ಆಪಕೆ ದ್ವಾರಾ ಖೇಜಾ ಗಯಾ ಪತ್ರ ಕಾ ಕೃಪಯಾ ಸಂದರ್ಭ ಲೆ ।

Reference is made to your letter on the above subject, requesting for Internship to the student/s of M.Sc (Physis) on No-Pay-No-Fee-Basis in our organization.

2. ನಿಮ್ನಾಕಿತ್ ವಿದ್ಯಾರ್ಥಿ ಕೆ ಪ್ರಯೋಗಶಾಲಾ, ಇಂಜಿನ್ ಭಾಗ, ಏಫಏಐಐ (ಬಿ.ಸಿ), ಬೆಂಗಳೂರು-93 ಮೆ ದಿನಾಂಕ 03-09-2018 ಸೆ 01-10-2018 ತಕ ಪ್ರಶಿಕೃತಾ ಹೆತು ಸ್ವೀಕೃತಿ ಪ್ರದಾನ ಕಿ ಜಾತಿ ಹೆ, ಷರತ್ ನಿಮ್ನಾನುಸಾರ ಹೆ.

We are pleased to accept the following student/s for Internship in Laboratory, Engine Division, HAL (BC), Bangalore-93 from 03-09-2018 ಸೆ 01-10-2018 subject to the Terms & Conditions mentioned below:-

ಕ್ರ.ಸಂ.	ವಿದ್ಯಾರ್ಥಿ ಕಾ ನಾಮ
Sl No	Name of the student/s (M/s)
1.	Bharathi V
2.	Deepa N

—ನೋಡೆ ಖೆ ಸ್ಥಿತಿ ಮೆ ಪರಿಯೋಜನೆ ಕಾರ್ಯ/ಇನ್-ಪ್ಲಾಂಟ್ ಪ್ರಶಿಕೃತಾ/ವೇತನ ರಹಿತ ನಿ:ಶುಲ್ಕ ಕೆ ಆಧಾರ ಪರ ಪ್ರಶಿಕೃತಾ ಕಿ ಅವಧಿ ಮೆ ಬದಲೆತರಿ ಯಾ ತಿಥಿ ಮೆ ಬದಲಾವ ಪರ ವಿಚಾರ ನೆಹಿ ಕಿಯಾ ಜಾಏಗಾ ।

Request or further extension of tenure / Change of dates for Project Work / In-plant-training/ Internship on No - Pay No Fee - basis will not be considered under any circumstances.

**ನಿಬಂಧ ಏವ್ ಷರತ್ / Terms and Conditions :-**

- ಪ್ರಶಿಕೃತಾ ಖಾಸಕರ್ ವೇತನ ರಹಿತ ನಿ:ಶುಲ್ಕ ಕೆ ಆಧಾರ ಪರ ಹೂಗಾ;  
The training is purely on No-Pay-No-Fee-Basis;
- ಸಂಸ್ಥಾನ ಕೆ ಪ್ರಾಮಾಣಿಕ ವಿದ್ಯಾರ್ಥಿ/ವಿದ್ಯಾರ್ಥಿ ಕೆ ಸಿಫಾರಿಶ ಕರನಾ ಚಾಹಿಏ;  
Only Bonafide student(s) of the institution should be sponsored;
- ವಿದ್ಯಾರ್ಥಿ/ವಿದ್ಯಾರ್ಥಿ ಕೆ ಅಧ್ಯಯನ ಕೆ ಅತಿಮ ವರ್ಷ ಕೆ ಪೂರ್ವ ವರ್ಷ / ಅತಿಮ ವರ್ಷ ಮೆ ಹೂನಾ ಚಾಹಿಏ;  
The student(s) should be in their pre-final / final year of studies;
- ವಿದ್ಯಾರ್ಥಿ/ವಿದ್ಯಾರ್ಥಿ ಕೆ ಭಾರತ ಕೆ ನಾಗರಿಕ ಹೂನಾ ಚಾಹಿಏ;  
The student(s) should be of Indian Nationality;
- ವಿದ್ಯಾರ್ಥಿ/ವಿದ್ಯಾರ್ಥಿ ಕೆ ಕಂಪನಿ ಕೆ ನಿಯಮ-ವಿನಿಯಮ ಕೆ ಸಖ್ತಿಯೆ ಪಾಲನ ಕರನಾ ಚಾಹಿಏ;  
The student(s) will strictly abide by the rules & regulations of the Company;

*[Signature]*  
PRINCIPAL  
The National College  
Javanagar, Bangalore-70



*[Signature]*



ಇ/ಮಾ.ಸಂ./ಪರಿಯोजना/2018/ E/HR/Project/2018

25-08-2018

The National College  
BENGALURU.

ಮಹೋದಯ/Dear Sir/ಮಹೋದಯ/Madam,

**ವಿಷಯ : ವೇತನ ರಹಿತ ನಿ:ಶುಲ್ಕ ಕೆ ಆಧಾರ ಪರ ಪ್ರಶಿಕ್ಷುತಾ ।**

**Sub: Internship on No-Pay-No-Fee-Basis.**

उपर्युक्त विषय पर वेंतन रहित नि:शुल्क के आधार पर M.Sc ( Physis) के विद्यार्थी के लिए प्रशिक्षुता हेतु अनुरोध करते हुए आपके द्वारा भेजा गया पत्र का कृपया संदर्भ लें ।

Reference is made to your letter on the above subject, requesting for Internship to the student/s of M.Sc (Physis) on No-Pay-No-Fee-Basis in our organization.

2. निम्नांकित विद्यार्थियों को प्रयोगशाला, इंजन प्रभाग, एचएएन (बीसी), बेंगलूरु-93 में दिनांक 03-09-2018 से 01-10-2018 तक प्रशिक्षुता हेतु स्वीकृति प्रदान की जाती है, बशर्त निम्नानुसार ही.

We are pleased to accept the following student/s for Internship in Laboratory, Engine Division, HAL (BC), Bangalore-93 from 03-09-2018 से 01-10-2018 subject to the Terms & Conditions mentioned below:-

क्र.सं. Sl No	विद्यार्थी का नाम Name of the student/s (M/s)
1	Bharathi V
2	Deepa N

कोई भी स्थिति में परियोजना कार्य/इनप्लांट प्रशिक्षण/वेंतन रहित नि:शुल्क के आधार पर प्रशिक्षुता की अवधि में बढ़ोतरी या तिथि में बदलाव पर विचार नहीं किया जाएगा ।

Request or further extension of tenure / Change of dates for Project Work / In-plant-training/ Internship on No - Pay No Fee - basis will not be considered under any circumstances.

**निबंध एवं शर्त / Terms and Conditions :-**

- प्रशिक्षण खासकर वेंतन रहित नि:शुल्क के आधार पर होगा;  
The training is purely on No-Pay-No-Fee-Basis;
- संस्थान के प्रामाणिक विद्यार्थी/विद्यार्थियों को सिफारिश करना चाहिए;  
Only Bonafide student(s) of the institution should be sponsored;
- विद्यार्थी/विद्यार्थियों अध्ययन के अंतिम वर्ष के पूर्व वर्ष / अंतिम वर्ष में होना चाहिए;  
The student(s) should be in their pre-final / final year of studies;
- विद्यार्थी/विद्यार्थियों भारत के नागरिक होना चाहिए;  
The student(s) should be of Indian Nationality;
- विद्यार्थी/विद्यार्थियों, कंपनी के नियम-विनियमों को सख्ती से पालन करना चाहिए;  
The student(s) will strictly abide by the rules & regulations of the Company;

  
PRINCIPAL  
The National College  
Javanagal, Bangalore-70





Page 1 - 3

ಹೆಚ್ಚಿನ ಮಾಹಿತಿಗಾಗಿ : 08/0, ಕಬ್ಬನ ರೋಡ್, ಬೆಂಗಳೂರು - 560 001, ಭಾರತ

पंजीकृत कार्यालय : 15/1, कब्यन रोड, बेंगलूरु - 560 001, भारत

Registered Office : 15/1, Cubbon Road, Bengaluru - 560 001, India

CIN : U35301KA1963GO1001622





**JAWAHARLAL NEHRU PLANETARIUM**  
**BANGALORE ASSOCIATION FOR SCIENCE EDUCATION**  
(A Registered Society of the Government of Karnataka)

Date: 13<sup>th</sup> November 2019

To,  
The Coordinator  
Department of Physics (P.G)  
National College (Autonomous)  
Jayanagar, Bengaluru-70.

Sir,

**Subject:** Acceptance to supervise M.Sc. (physics) project

As you may know that the students listed below approached me and requested to suggest and supervise a project in Astronomy. As per the discussion with students I have agreed to supervise their project "Scope and relevance of UV telescopes".

List of students

- 1) Ms. Sushmitha N S
- 2) Ms. Sushmitha S
- 3) Mr. Manju Vasanth Maladkar
- 4) Mr. Sharath Kumar T.S.

Thanking you

*[Handwritten Signature]*  
PRINCIPAL

The National College  
Jayanagar, Bangalore-70

Yours Sincerely

*[Handwritten Signature]*





Jayant Murthy  
The Indian Institute of Astrophysics  
Koramangala  
Bangalore 560034  
India

E-mail: [jmurthy@yahoo.com](mailto:jmurthy@yahoo.com)  
Mobile: (91)9844044228  
Off: (91)(80)25539250x263  
FAX: (91) (80) 25534043  
<http://www.iia.res.in/personnel/murthy/index.htm>

PG coordinator,  
Department of Postgraduate  
studies and research in Physics

Jul 11, 2018

I am pleased to offer a project entitled "Analysis of the ultraviolet sky from spacecraft data" to:

- 1) Mounica K.
- 2) Abishek P.
- 3) Shankar SA

I look forward to working with the students in this exciting project.

Sincerely

*Jayant Murthy*

Jayant Murthy  
Senior Professor

*D. Sudh*

PRINCIPAL  
The National College  
Jayanagar, Bangalore-70.





ಶಿಕ್ಷಣದ ಮೂಲಕ ಸಂಪನ್ಮೂಲ

## Declaration

I NAGENDRA PRASAD B.K [17NCJPP017] declare that, to the best of my conscience the project entitled "Fabrication and Performance Evaluation of Thin film Inductor" was performed by me, under the guidance of Dr. K R Gunasekhar, Principal Research Scientist, Department of Instrumentation and Applied Physics, Indian Institute of Science, Bengaluru - 560012. The work has not been submitted in substance before for any degree.

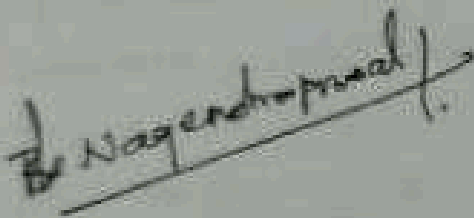

NAGENDRA PRASAD B.K

[17NCJPP017]

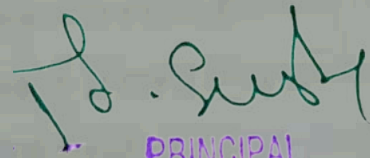

PRINCIPAL

The National College  
Jayanagar, Bangalore-70.





Dr. K. R. Gunasekhar

Principal Research Scientist

Department of Instrumentation and Applied Physics

Indian Institute of Science, Bengaluru

Dr. K.R. GUNASEKHAR  
Principal Research Scientist  
Dept. Of Instrumentation & Applied Physics  
Indian Institute of Science  
Bangalore - 560 012, India.  
Ph : 080-22933194, E-mail : krguna@iisc.ac.in





Jayant Murthy  
The Indian Institute of Astrophysics  
Koramangala  
Bangalore 560034  
India

E-mail: [jmurthy@yahoo.com](mailto:jmurthy@yahoo.com)  
Mobile: (91)9844044228  
Off: (91)(80)25539250x263  
FAX: (91) (80) 25534043  
<http://www.iiap.res.in/personnel/murthy/index.htm>

PG coordinator,  
Department of Postgraduate  
studies and research in Physics

Jul 11, 2018

I am pleased to offer a project entitled "Analysis of the ultraviolet sky from spacecraft data" to:

- 1) Mounica K.
- 2) Abishek P.
- 3) Shankar SA

I look forward to working with the students in this exciting project.

Sincerely

Jayant Murthy  
Senior Professor

PRINCIPAL  
The National College  
Jayanagar, Bangalore-70.



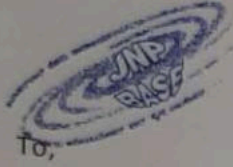

**JAWAHARLAL NEHRU PLANETARIUM**  
**BANGALORE ASSOCIATION FOR SCIENCE EDUCATION**  
(A Registered Society of the Government of Karnataka)

Date: 13<sup>th</sup> November 2019

To,  
The Coordinator  
Department of Physics (P.G)  
National College (Autonomous)  
Jayanagar, Bengaluru-70.

Sir,

**Subject:** Acceptance to supervise M.Sc. (physics) project

As you may know that the students listed below approached me and requested to suggest and supervise a project in Astronomy. As per the discussion with students I have agreed to supervise their project "Scope and relevance of UV telescopes".

List of students

- 1) Ms. Sushmitha N S
- 2) Ms. Sushmitha S
- 3) Mr. Manju Vasanth Maladkar
- 4) Mr. Sharath Kumar T.S.

Thanking you

Yours Sincerely

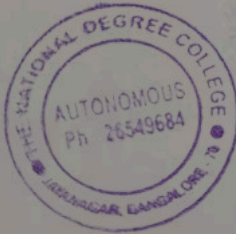

PRINCIPAL

The National College  
Jayanagar, Bangalore-70.



**JAWAHARLAL NEHRU PLANETARIUM**  
**BANGALORE ASSOCIATION FOR SCIENCE EDUCATION**  
(A Registered Society of the Government of Karnataka)

Date: 13<sup>th</sup> November 2019

To,  
The Coordinator  
Department of Physics (P.G)  
National College (Autonomous)  
Jayanagar, Bengaluru-70.

Sir,

**Subject:** Acceptance to supervise M.Sc. (physics) project

As you may know that the students listed below approached me and requested to suggest and supervise a project in Astronomy. As per the discussion with students I have agreed to supervise their project "Scope and relevance of UV telescopes".

List of students

- 1) Ms. Sushmitha N S
- 2) Ms. Sushmitha S
- 3) Mr. Manju Vasanth Maladkar
- 4) Mr. Sharath Kumar T.S.

Thanking you

Yours Sincerely



PRINCIPAL  
The National College  
Jayanagar, Bangalore-70.



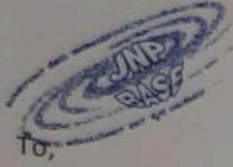

**JAWAHARLAL NEHRU PLANETARIUM**  
**BANGALORE ASSOCIATION FOR SCIENCE EDUCATION**  
(A Registered Society of the Government of Karnataka)

Date: 13<sup>th</sup> November 2019

To,  
The Coordinator  
Department of Physics (P.G)  
National College (Autonomous)  
Jayanagar, Bengaluru-70.

Sir,

**Subject:** Acceptance to supervise M.Sc. (physics) project

As you may know that the students listed below approached me and requested to suggest and supervise a project in Astronomy. As per the discussion with students I have agreed to supervise their project "Scope and relevance of UV telescopes".

List of students

- 1) Ms. Sushmitha N S
- 2) Ms. Sushmitha S
- 3) Mr. Manju Vasanth Maladkar
- 4) Mr. Sharath Kumar T.S.

Thanking you

Yours Sincerely

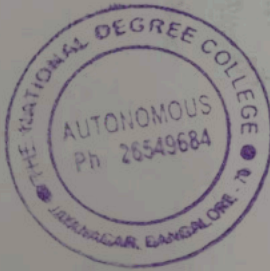

PRINCIPAL  
The National College  
Jayanagar, Bangalore-70.

**Dr. K. Gopukumar, PhD**  
Consultant Neuropsychologist





**BENGALURU  
NEURO CENTRE**

19<sup>th</sup> March, 2021  
Bangalore.

**TO WHOMSOEVER IT MAY CONCERN**

This is to certify that Ms. Dhriti P Desai, a student of II-year BA., Psychology, National College, Jayanagar, Bangalore, has successfully completed one week [from 13<sup>st</sup> March to 19<sup>th</sup> March 2021] observership at Neuropsychology Unit, Bangalore Neuro Centre, Bangalore. During the period of her observership, she observed, IQ assessment Neuropsychological Assessment (Children & Adult), Counselling, Cognitive Behaviour therapy, relaxation therapy (JPMR & Benson's), cognitive re-training sessions, case discussion and, other therapy sessions. She was found to be sincere, hardworking, and motivated. She worked well as part of the team during her tenure. We take this opportunity to thank her and wish her all the best.

  
Dr. Gopukumar Kumarpillai, Ph.D., Post Doc.,  
Neuropsychologist  
Bangalore Neuro Centre,  
10<sup>th</sup> Cross, Malleshwaram,  
Bangalore – 560003.

  
PRINCIPAL  
The National College  
Jayanagar, Bangalore-70.



**Bengaluru Neuro Center Pvt. Ltd**  
# 27/5, 10th Cross, 3rd Main  
Margosa Road, Malleshwaram

Scanned By Scanner Go





**LITTLE BLUEJAYS CARE PVT LTD**

Little Bluejays  
Specialized Care for Children with Special Needs

Dear sir/ Madam

This is to certify that Miss.Nayana Thara.R student of Psychology from National College attended Little Bluejays care Pvt Ltd for internship program from 1<sup>st</sup> June to 25<sup>th</sup> June 2018. During her internship period she has observed the Early Intervention services given to the kids with Autism, ADHD, Intellectual Deficit, and Genetic Disorder. The center works with the Interdisciplinary Model where they provide Behaviour Modification therapy, Cognitive Behavior Therapy, Occupational Therapy, Physiotherapy, Speech therapy and Special education. The center also provides Screening, Consultation and Assessment depending on the need of the child condition for which detailed report is issued.

She has observed the whole process and therapies conducted in the center. She has submitted one detailed case history report and case summary reports of the clients which she has observed. During the intemship period she has shown immense interest and genuine willingness to learn, and zeal to take new assignments given to her.

We wish Nayani Thara.R all the very best for her future.

*Kruthika.V*

Warm Regards

Kruthika.V

Msc Clinical Psychology

Little Bluejays Care Pvt Ltd.

*D. Sudh*

PRINCIPAL

The National College  
Jayanagar, Bangalore-70.



**Psychologist  
Little Blue Jays Care**



# SPANDANA HEALTH CARE

No.236/2, 29th Main, 5th Block, Nandini Layout, (Coconut Garden), Near Ring Road Bridge,  
Bangalore - 560 096. Phone : 23595652 / 9035560000 / 9036680000  
CIN - U05110KA2004PTC034140

Ref:

Date: 16/12/2019

This is to state that **Mr. Prajwal Raghavendra. R.** (Roll no: 17NCJA046) student of third year B.A Psychology Programme, at **The National College**, Bangalore, had attended his internship programme, from December 06<sup>th</sup> 2019 to December 20<sup>th</sup> 2019 at **Spandana Health Care**, Nandini Layout, Bangalore.

During his tenure as an intern at Spandana Health Care, he was actively involved in observing clinical interviews and assessments carried out for patients at the hospital. Also, he participated in various activities at the hospital such as group counselling sessions, psychoeducational activities and individual/group supervision hours for interns at the hospital. He showed his interest in learning/understanding various mental health disorders and was consistent in completing the assigned tasks of the internship programme.

We wish him all the success for his future endeavours.

  
Dr Mahesh Gowda  
Managing Director  
Spandana Health Care

16/12/19

**SPANDANA HEALTH CARE**  
Sy. No. 236/2, 29th Main, 5th Block,  
Nandini Layout, (Coconut Garden)  
Near Ring Road, Bridge, Bangalore-06



PRINCIPAL

The National College  
Jayanagar, Bangalore-70



*Committed to Mental Health Care*



Dr. K. Gopukumar, PhD  
Consultant Neuropsychologist





## BENGALURU NEURO CENTRE

19<sup>th</sup> March, 2021  
Bangalore.

### TO WHOMSOEVER IT MAY CONCERN

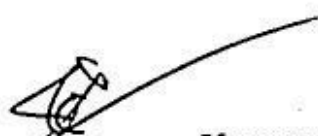
This is to certify that Ms. Shilpa B, a student of II-year B.A., Psychology, National College, Jayanagar, Bangalore, has successfully completed one week [from 13<sup>st</sup> March to 19<sup>th</sup> March 2021] observership at Neuropsychology Unit, Bangalore Neuro Centre, Bangalore. During the period of her observership, she observed, IQ assessment Neuropsychological Assessment (Children & Adult), Counselling, Cognitive Behaviour therapy, relaxation therapy (JPMR & Benson's), cognitive re-training sessions, case discussion and, other therapy sessions. She was found to be sincere, hardworking, and motivated. She worked well as part of the team during her tenure. We take this opportunity to thank her and wish her all the best.

  
Dr. Gopukumar Kumarpillai, Ph.D., Post Doc.,  
Neuropsychologist  
Bangalore Neuro Centre,  
10<sup>th</sup> Cross, Malleshwaram,  
Bangalore - 560003.

  
PRINCIPAL  
The National College  
Jayanagar, Bangalore-70.

Bengaluru Neuro Center Pvt. Ltd  
# 27/5, 10th Cross, 3rd Main  
Margosa Road, Malleshwaram,  
Bangalore-560 003





**Dr. K. Gopukumar, PhD**  
Consultant Neuropsychologist



**BENGALURU  
NEURO CENTRE**

19<sup>th</sup> March, 2021  
Bangalore.

**TO WHOMSOEVER IT MAY CONCERN**

This is to certify that Ms. Srushti jagadish, a student of II-year BA., Psychology, National College, Jayanagar, Bangalore, has successfully completed one week [from 13<sup>st</sup> March to 19<sup>th</sup> March 2021] observership at Neuropsychology Unit, Bangalore Neuro Centre, Bangalore. During the period of her observership, she observed, IQ assessment Neuropsychological Assessment (Children & Adult), Counselling, Cognitive Behaviour therapy, relaxation therapy (JPMR & Benson's), cognitive re-training sessions, case discussion and, other therapy sessions. She was found to be sincere, hardworking, and motivated. She worked well as part of the team during her tenure. We take this opportunity to thank her and wish her all the best.

  
Dr. Gopukumar Kumarpillai, Ph.D., Post Doc.,  
Neuropsychologist  
Bangalore Neuro Centre,  
10<sup>th</sup> Cross, Malleshwaram,  
Bangalore – 560003.

**Bengaluru Neuro Center Pvt. Ltd**  
# 27/5, 10th Cross, 3rd Main  
Margosa Road, Malleshwaram  
Bangalore-560 003

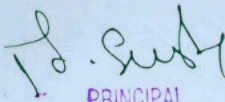
  
PRINCIPAL  
The National College  
Jayanagar, Bangalore-70.





**THE NATIONAL COLLEGE**  
**Autonomous**  
**Jayanagar, Bangalore-560070**

**CERTIFICATE**

This is to certify that the project report titled " Dell" is a bonafide record of work done by **GOWTHAMI.B. DEVRAJ(19NCJB701)** of **THE NATIONAL COLLEGE, Jayanagar, Bangalore**, in partial fulfilment of the requirements of **IV Semester BCA [IOT]** during the year **2020-2021**.

**HEAD OF THE DEPARTMENT**

**PROJECT GUIDE**

**DATE OF EXAMINATION:**

**STUDENT SIGNATURE:**

*C/K*  
Head, Dept of English  
[The National Degree College]  
(Autonomous, 7th Block,  
Jayanagar, Bangalore - 70)



*Gowthami B. Devraj*  
PRINCIPAL  
The National College





|| ಶ್ರದ್ಧಾಽ ಪರಮಾ ಗತಃ ||

**THE NATIONAL COLLEGE**  
Autonomous  
Jayanagar, Bangalore-560070

**CERTIFICATE**

This is to certify that the project report on "RESEARCH OF A COMPANY" titled "Reliance Jio Infocomm Limited" is a bonafide record of work done by PRAMODH N(19NCJB702) of THE NATIONAL COLLEGE, Jayanagar, Bangalore, in partial fulfilment of the requirements of IV Semester BCA [IOT], TECHNICAL ENGLISH during the year 2020-2021.

**HEAD OF THE DEPARTMENT**

  
**PROJECT GUIDE**

**DATE OF EXAMINATION:**

  
**STUDENT SIGNATURE:**

  
Head, Dept of English  
The National Degree College  
(Autonomous) 7th Block,  
Jayanagar, Bangalore - 70.

(PRAMODH N) 19NCJB702



  
PRINCIPAL  
The National College  
Jayanagar, Bangalore-70.





॥ ಶ್ರದ್ಧಾಪಿ ಪರಮಾ ಗತಿಃ ॥

**THE NATIONAL COLLEGE**  
Autonomous  
Jayanagar, Bangalore-560070

**CERTIFICATE**

This is to certify that the project report on “RESEARCH OF A COMPANY” titled “MICROSOFT CORPORATION” is a bonafide record of work done by INCHARA R (19NCJB703) of THE NATIONAL COLLEGE, Jayanagar, Bangalore, in partial fulfilment of the requirements of IV Semester BCA [IOT], TECHNICAL ENGLISH during the year 2020-2021.

STUDENT SIGNATURE:

PROJECT GUIDE:

HEAD-OF THE DEPARTMENT:

Head, Dept of English  
The National Degree College  
(Autonomous) 7th Block,  
Jayanagar, Bangalore - 70.



PRINCIPAL  
The National College  
Jayanagar, Bangalore-70



**THE NATIONAL COLLEGE**  
Autonomous  
Jayanagar, Bangalore-560070

**CERTIFICATE**

This is to certify that the project report on "RESEARCH OF A COMPANY" titled "ELECTRONIC ARTS" is a bonafide record of work done by JAYATHEERTHA.B(19NCJB704) of THE NATIONAL COLLEGE, Jayanagar, Bangalore, in partial fulfilment of the requirements of IV Semester BCA [IOT], TECHNICAL ENGLISH during the year 2020-2021.

STUDENT SIGNATURE: Jayatheertha B.

  
PROJECT GUIDE:

  
HEAD OF THE DEPARTMENT:

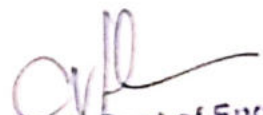
  
Head, Dept of English  
The National Degree College  
(Autonomous) 7th Block,  
Jayanagar, Bangalore - 70.

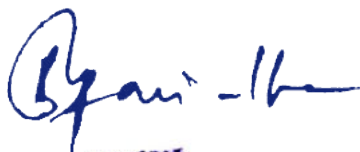

  
PRINCIPAL  
The National College  
Jayanagar, Bangalore-70.



**THE NATIONAL COLLEGE**  
Autonomous  
Jayanagar, Bangalore- 560070

॥ ಶ್ರದ್ಧಾಹಿ ಪರಮಾ ಗತಿಃ ॥

**CERTIFICATE**

This is to certify that the project report on **“RESEARCH OF A COMPANY”** titled **“Google”** is a bonafide record of work done by **Shreyas Rao T S (19NCJB705)** of **THE NATIONAL COLLEGE**, Jayanagar, Bangalore, in partial fulfillment of the requirements of **IV Semester BCA [IOT], TECHNICAL ENGLISH** during the year **2020-2021**.

DATE:

STUDENT SIGNATURE: Shreyas Rao TS

Cluz  
PROJECT GUIDE:

HEAD OF DEPARTMENT:

CME  
Head, Dept of English  
The National Degree College  
(Autonomous) 7th Block,  
Jayanagar, Bangalore - 70.



Gyan  
PRINCIPAL  
The National College  
Jayanagar, Bangalore-70.





॥ ಶ್ರದ್ಧಾಹಿ ಪರಮಾ ಗತಿಃ ॥

# THE NATIONAL COLLEGE

Autonomous

Jayanagar, Bangalore-560070

## CERTIFICATE

This is to certify that the project report titled "FACEBOOK" is a bonafide record of work done by **CHARAN S (19NCJB707)** of **THE NATIONAL COLLEGE**, Jayanagar, Bangalore, in partial fulfilment of the requirements of **IV Semester BCA [IOT]** during the year **2020-2021**.

**HEAD OF THE DEPARTMENT**

**PROJECT GUIDE**

DATE OF EXAMINATION: .....

STUDENT SIGNATURE:

Head, Dept of English  
The National Degree College  
(Autonomous) 7th Block,  
Jayanagar, Bangalore - 70.



**CHARAN S (19NCJB707)**

PRINCIPAL  
The National College  
Jayanagar, Bangalore-70.



**THE NATIONAL COLLEGE**  
Autonomous  
Jayanagar, Bangalore-560070

**CERTIFICATE**

This is to certify that the project report on "RESEARCH OF A COMPANY" titled "MITSUBISHI CORPORATION" is a bonafide record of work done by PRUTHVI A-19NCJB709 of THE NATIONAL COLLEGE, Jayanagar, Bangalore, in partial fulfilment of the requirements of 4TH Semester BCA [IOT], TECHNICAL ENGLISH during the year 2020-2021.

STUDENT SIGNATURE: Pruthvi

  
PROJECT GUIDE:

  
HEAD OF THE DEPARTMENT:

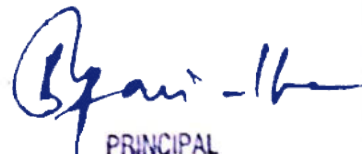
  
PRINCIPAL  
The National College  
Jayanagar, Bangalore-70

Head, Dept of English  
The National College  
(Autonomous) Block  
Jayanagar, Bangalore - 70





|| ಶ್ರದ್ಧಾಪೂಜಾ ಪಠನಾ ||

**THE NATIONAL COLLEGE**  
Autonomous  
Jayanagar, Bangalore-560070

**CERTIFICATE**

This is to certify that the project report on "RESEARCH OF A COMPANY" titled "TESLA INCORPORATION" is a bonafide record of work done by SHASHANK R (19NCJB710) of THE NATIONAL COLLEGE, Jayanagar, Bangalore, in partial fulfilment of the requirements of IV Semester BCA [IOT], TECHNICAL ENGLISH during the year 2020-2021.

STUDENT SIGNATURE: *Shashank.R*

*[Handwritten signature]*

PROJECT GUIDE:

*[Handwritten signature]*

HEAD OF THE DEPARTMENT:

Head, Dept of English  
The National Degree College,  
(Autonomous) 7th Block,  
Jayanagar, Bangalore - 70



*[Handwritten signature]*  
PRINCIPAL  
The National College  
Jayanagar, Bangalore-70.





॥ ಪ್ರವೃತ್ತಿ ಪರಮಾ ಗತಿ: ॥

# THE NATIONAL COLLEGE

Autonomous

Jayanagar, Bangalore-560070

## CERTIFICATE

This is to certify that the project report on “RESEARCH OF A COMPANY” titled “APPLE INC.” is a bonafide record of work done by YADUNANDAN A B (19NCJB711) of THE NATIONAL COLLEGE, Jayanagar, Bangalore, in partial fulfilment of the requirements of IV Semester BCA [IOT], TECHNICAL ENGLISH during the year 2020-2021.

HEAD OF THE DEPARTMENT

DATE OF EXAMINATION:

PROJECT GUIDE

STUDENT SIGNATURE:

(YADUNANDAN A B) 19NCJB711

Head, Dept of English  
The National Degree College  
(Autonomous, 7th Block,  
Jayanagar, Bangalore - 70)



PRINCIPAL  
The National College  
Jayanagar, Bangalore-70



॥ वाचस्पतिं शरणं गच्छ ॥

# THE NATIONAL COLLEGE

Autonomous  
Jayanagar, Bangalore-560070

## CERTIFICATE

This is to certify that the project report "RESEARCH OF A COMPANY" titled "TATA MOTORS" is a bonafide record of work done by SANKET GUDAKETRA (19NCJB712) of THE NATIONAL COLLEGE, Jayanagar, Bangalore, in partial fulfilment of the requirements of IV Semester BCA [IOT] during the year 2020-2021.

*Sanket Gudaketra*

STUDENT SIGNATURE:

*Chao*

PROJECT GUIDE:

*Chao*

HEAD OF THE DEPARTMENT:

Head, Dept of English  
The National Degree College  
(Autonomous) III Block,  
Jayanagar, Bangalore - 70



*Pravin*  
PRINCIPAL  
The National Degree College  
(Autonomous) III Block,  
Jayanagar, Bangalore - 70

# SAPNE

Secure The Childs Future



Date: 09/08/2020

This certificate is presented to: GurunagaNandan. N

For your dedication to your profession in the department  
and for being the "BEST INTERN".

MASS COMMUNICATION

A handwritten signature in black ink, appearing to read 'GurunagaNandan. N', is written over a horizontal line.

Signature

CERTIFICATE  
OF  
APPRECIATION



Dr. K. Gopukumar, PhD  
Consultant Neuropsychologist



## BENGALURU NEURO CENTRE

19<sup>th</sup> March, 2021  
Bangalore.

### TO WHOMSOEVER IT MAY CONCERN

This is to certify that Ms. Shilpa B, a student of II-year B.A., Psychology, National College, Jayanagar, Bangalore, has successfully completed one week [from 13<sup>st</sup> March to 19<sup>th</sup> March 2021] observership at Neuropsychology Unit, Bangalore Neuro Centre, Bangalore. During the period of her observership, she observed, IQ assessment Neuropsychological Assessment (Children & Adult), Counselling, Cognitive Behaviour therapy, relaxation therapy (JPMR & Benson's), cognitive re-training sessions, case discussion and, other therapy sessions. She was found to be sincere, hardworking, and motivated. She worked well as part of the team during her tenure. We take this opportunity to thank her and wish her all the best.

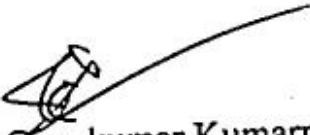
  
Dr. Gopukumar Kumarpillai, Ph.D., Post Doc.,  
Neuropsychologist  
Bangalore Neuro Centre,  
10<sup>th</sup> Cross, Malleshwaram,  
Bangalore - 560003.

Bengaluru Neuro Center Pvt. Ltd  
# 27/5, 10th Cross, 3rd Main  
Margosa Road, Malleshwaram,  
Bangalore-560 003

**Dr. K. Gopukumar, PhD**  
Consultant Neuropsychologist



**BENGALURU  
NEURO CENTRE**

19<sup>th</sup> March, 2021  
Bangalore.

**TO WHOMSOEVER IT MAY CONCERN**

This is to certify that Ms. Srushti jagadish, a student of II-year BA., Psychology, National College, Jayanagar, Bangalore, has successfully completed one week [from 13<sup>st</sup> March to 19<sup>th</sup> March 2021] observership at Neuropsychology Unit, Bangalore Neuro Centre, Bangalore. During the period of her observership, she observed, IQ assessment Neuropsychological Assessment (Children & Adult), Counselling, Cognitive Behaviour therapy, relaxation therapy (JPMR & Benson's), cognitive re-training sessions, case discussion and, other therapy sessions. She was found to be sincere, hardworking, and motivated. She worked well as part of the team during her tenure. We take this opportunity to thank her and wish her all the best.

  
Dr. Gopukumar Kumarpillai, Ph.D., Post Doc.,  
Neuropsychologist  
Bangalore Neuro Centre,  
10<sup>th</sup> Cross, Malleshwaram,  
Bangalore – 560003.

**Bengaluru Neuro Center Pvt. Ltd**  
\* 27/5, 10th Cross, 3rd Main  
Margosa Road, Malleshwaram  
Bangalore-560 003



**Dr. K. Gopukumar, PhD**  
Consultant Neuropsychologist



**BENGALURU  
NEURO CENTRE**

19<sup>th</sup> March, 2021  
Bangalore.

**TO WHOMSOEVER IT MAY CONCERN**

This is to certify that Ms. Dhriti P Desai, a student of II-year BA., Psychology, National College, Jayanagar, Bangalore, has successfully completed one week [from 13<sup>st</sup> March to 19<sup>th</sup> March 2021] observership at Neuropsychology Unit, Bangalore Neuro Centre, Bangalore. During the period of her observership, she observed, IQ assessment Neuropsychological Assessment (Children & Adult), Counselling, Cognitive Behaviour therapy, relaxation therapy (JPMR & Benson's), cognitive re-training sessions, case discussion and, other therapy sessions. She was found to be sincere, hardworking, and motivated. She worked well as part of the team during her tenure. We take this opportunity to thank her and wish her all the best.

Dr. Gopukumar Kumarpillai, Ph.D., Post Doc.,  
Neuropsychologist  
Bangalore Neuro Centre,  
10<sup>th</sup> Cross, Malleshwaram,  
Bangalore – 560003.

**Bengaluru Neuro Center Pvt. Ltd**  
# 27/5, 10th Cross, 3rd Main  
Margosa Road, Malleshwaram



Scanned By Scanner Go